

Laredo, TX Regional ITS Architecture  
Customized Market Package Diagrams

Commercial Vehicle Operations (CVO)

# CVO01/CVO02 - Fleet Administration/Freight Administration

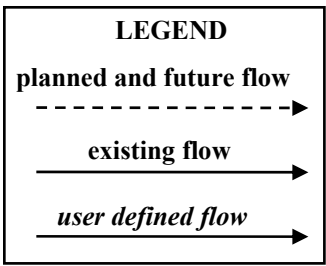
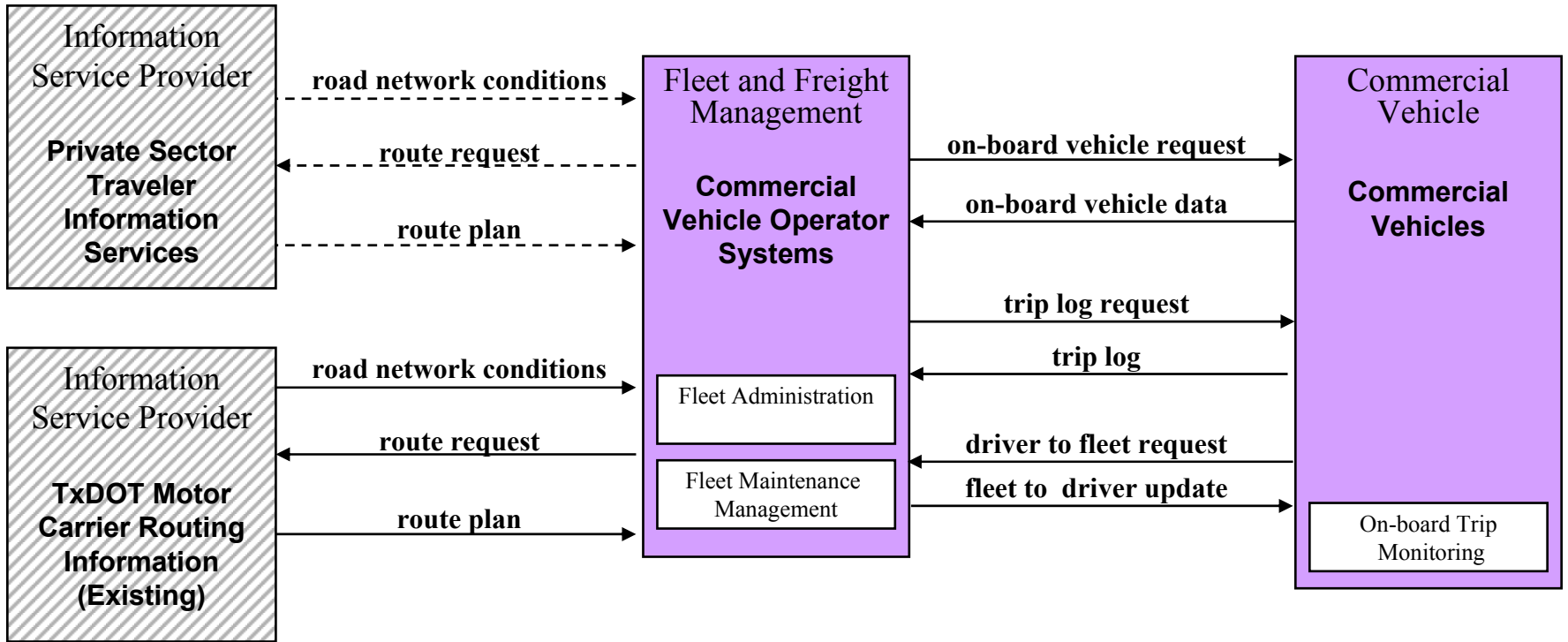

# CVO03 - Electronic Clearance

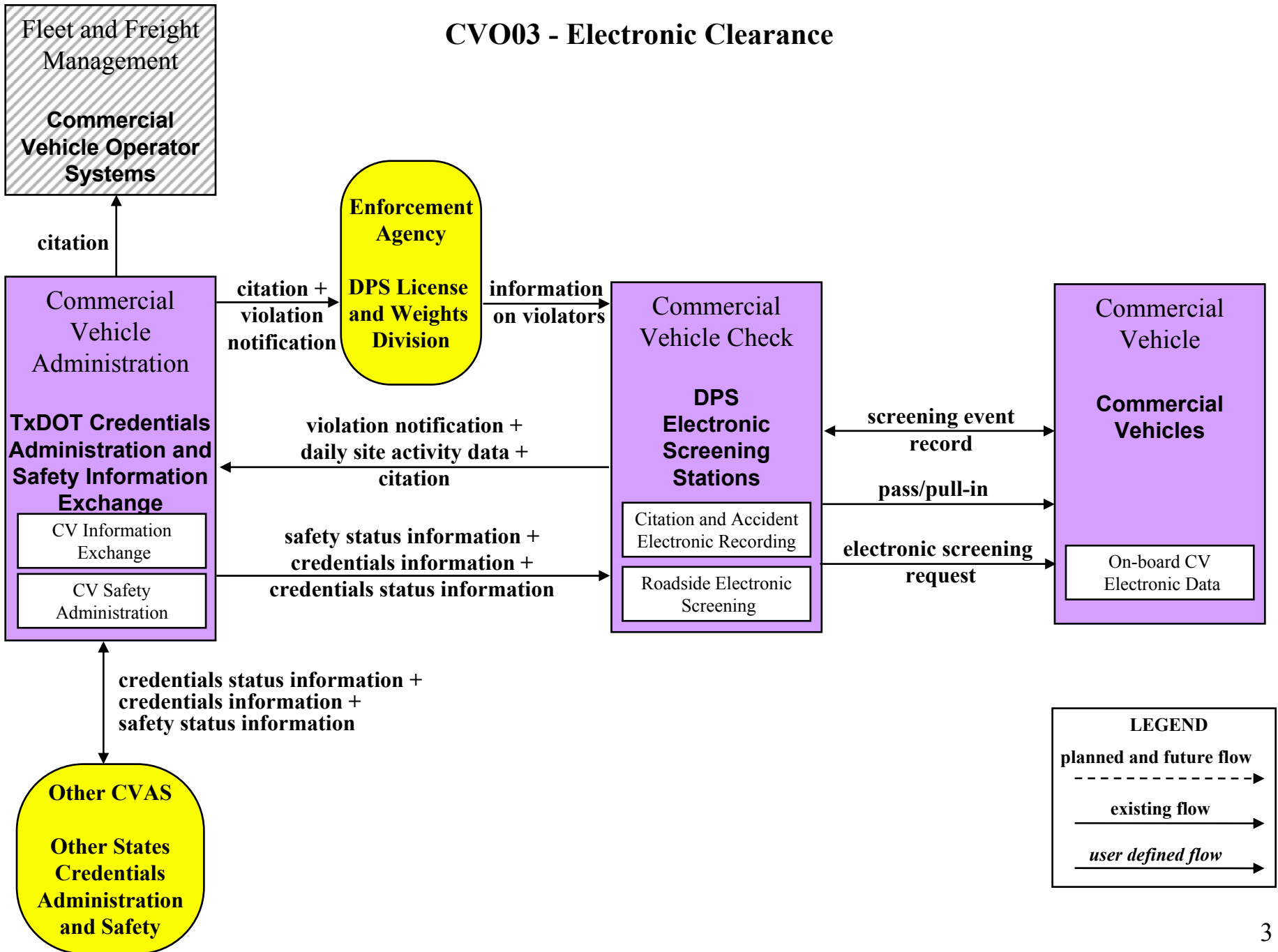

# CVO04 - CV Administrative Processes

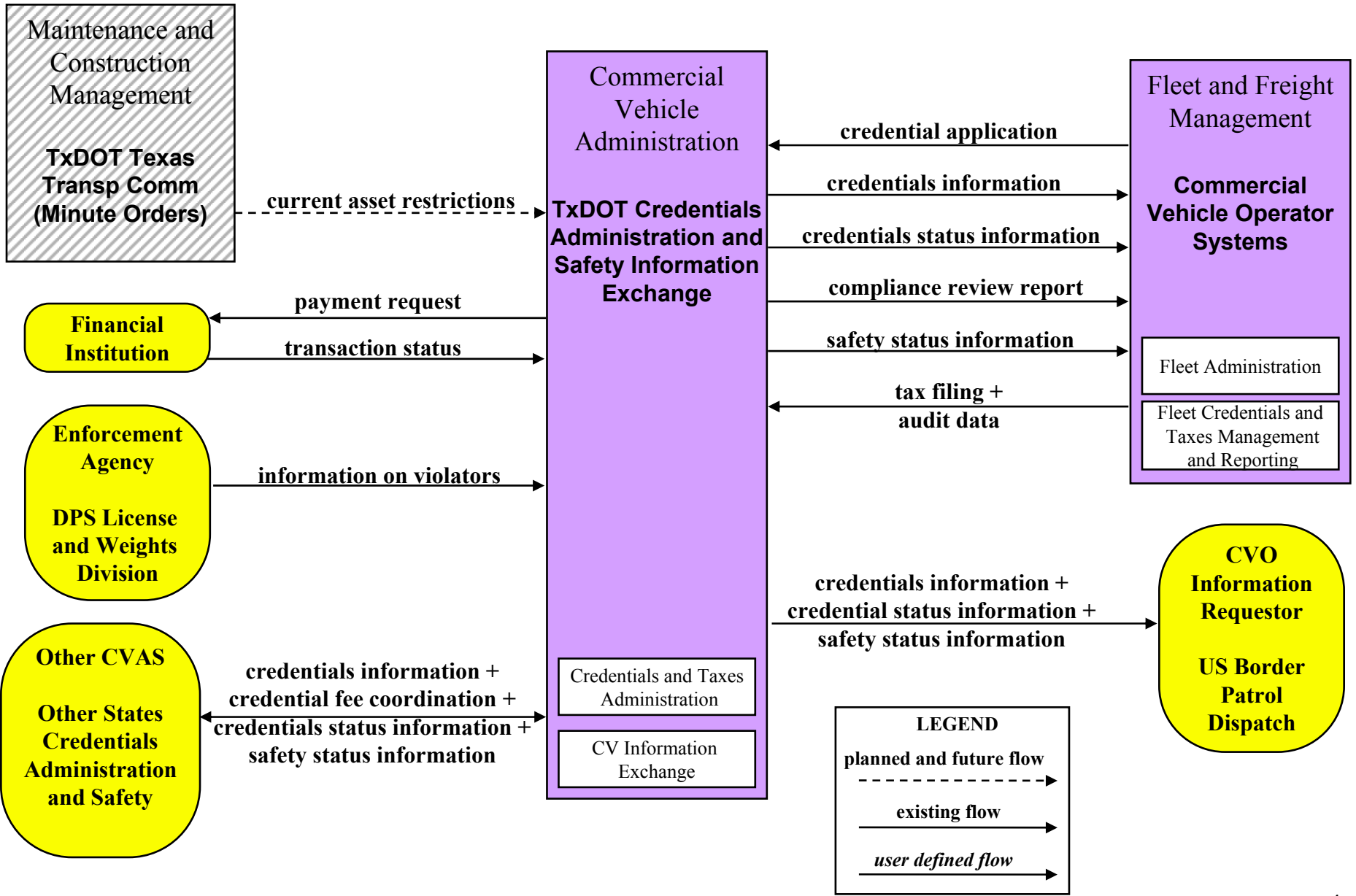

# CVO04 - CV Administrative Processes

## Routes inside the City

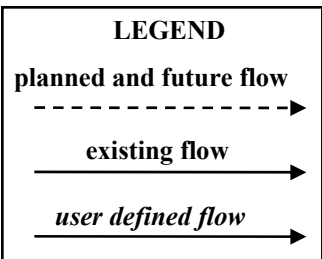
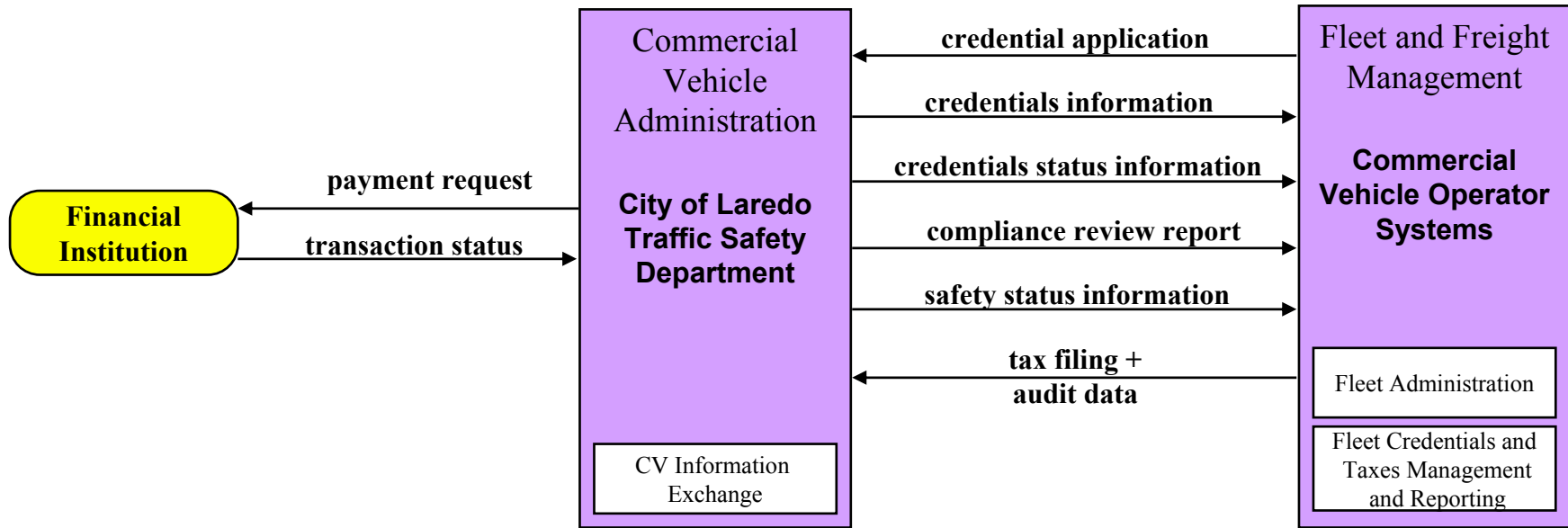

# CVO05 - International Border Electronic Clearance

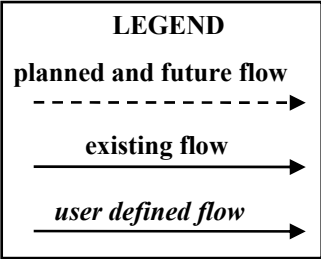

**Commercial Vehicle Administration.**

**TxDOT Credentials Administration and Safety Information Exchange**

CV Safety Administration

CV Information Exchange

International CV Administration

**Fleet and Freight Management Commercial Vehicle Operator Systems**

Fleet Administration

Freight Administration and Management

**Intermodal Freight Shipper**

Private Shippers

**Other CVAS**

**Other States Credentials Administration and Safety**

**Commercial Vehicle Check DPS Electronic Screening Stations**

International Border Crossing

Roadside Electronic Screening

**Commercial Vehicle Commercial Vehicles**

On-board CV Electronic Data

**CVO Inspector**

**US Border Patrol**

**Trade Regulatory Agencies**

**US Border Patrol Dispatch Center**

**US Customs Product Manifest System**

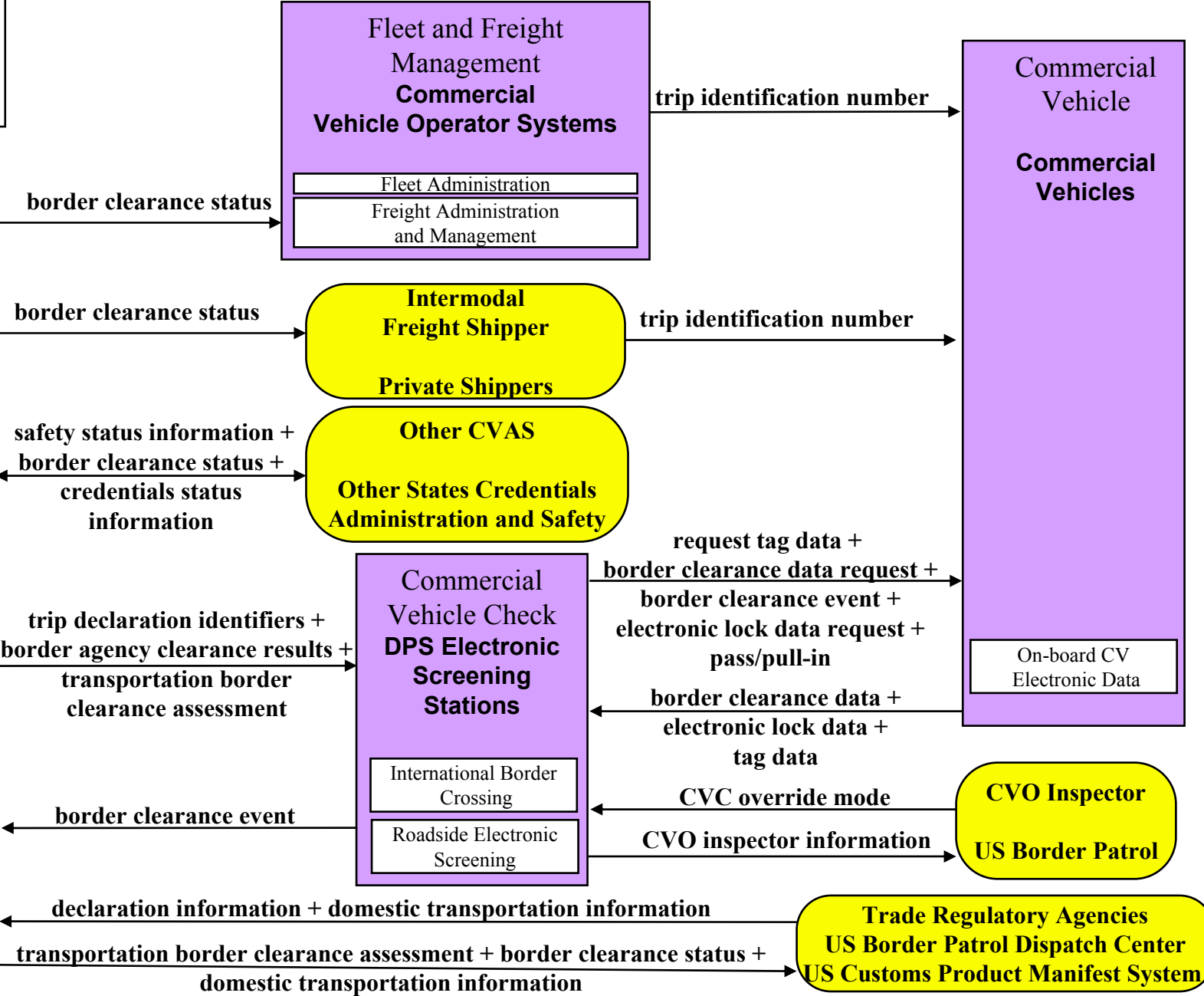

# CVO06 - Weigh-In-Motion

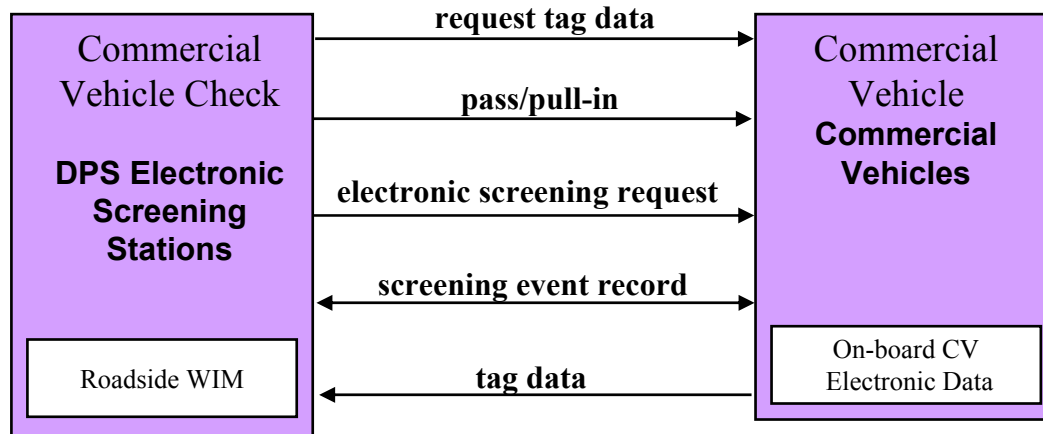

## LEGEND

**planned and future flow**

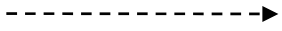

**existing flow**

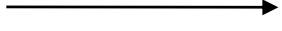

**user defined flow**

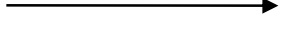

# CVO07 - Roadside CVO Safety

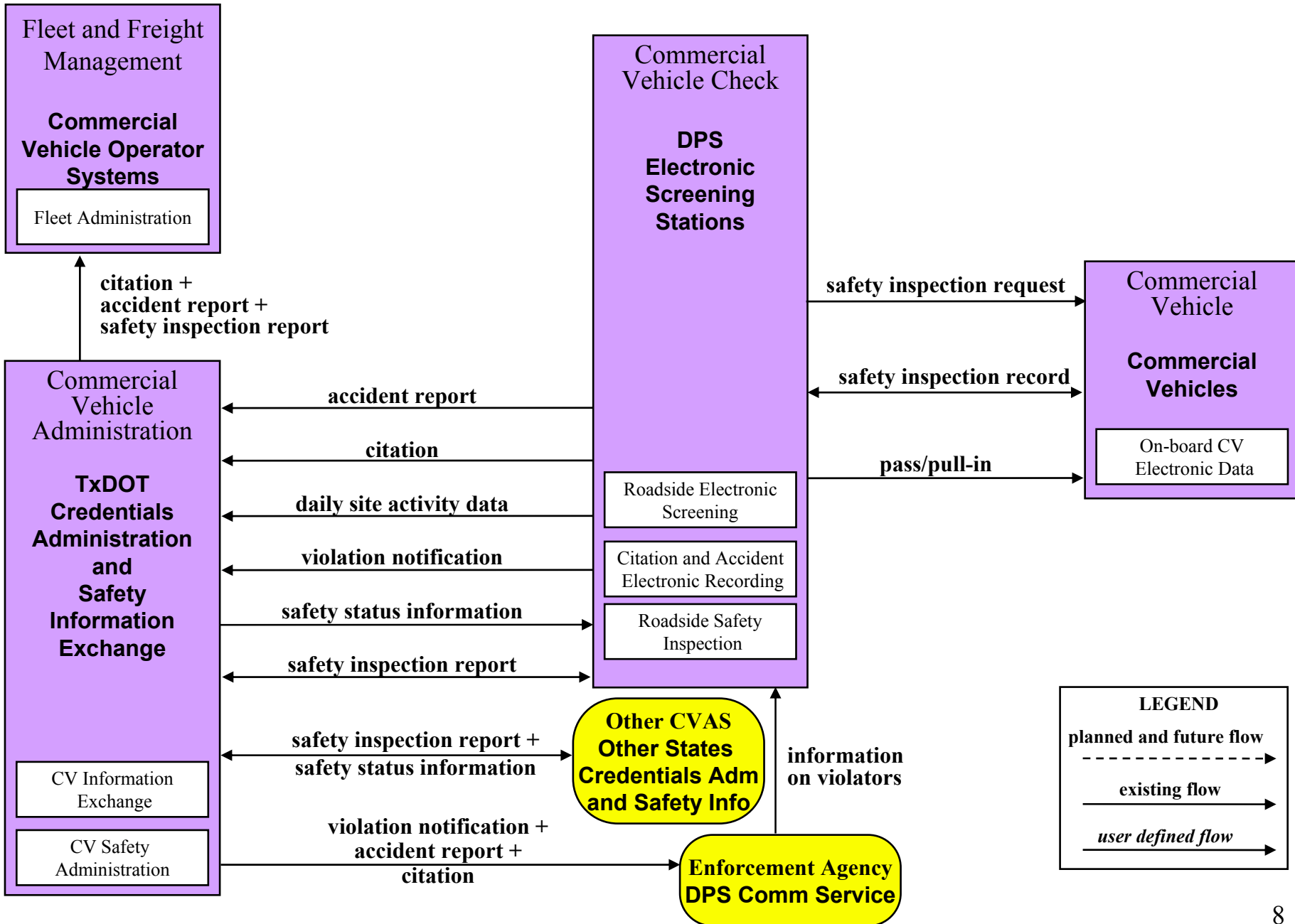



# CVO08 - On-board CVO Safety

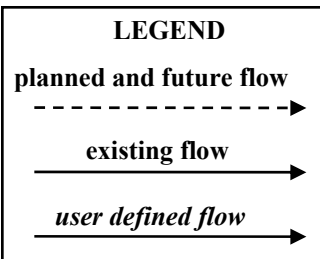
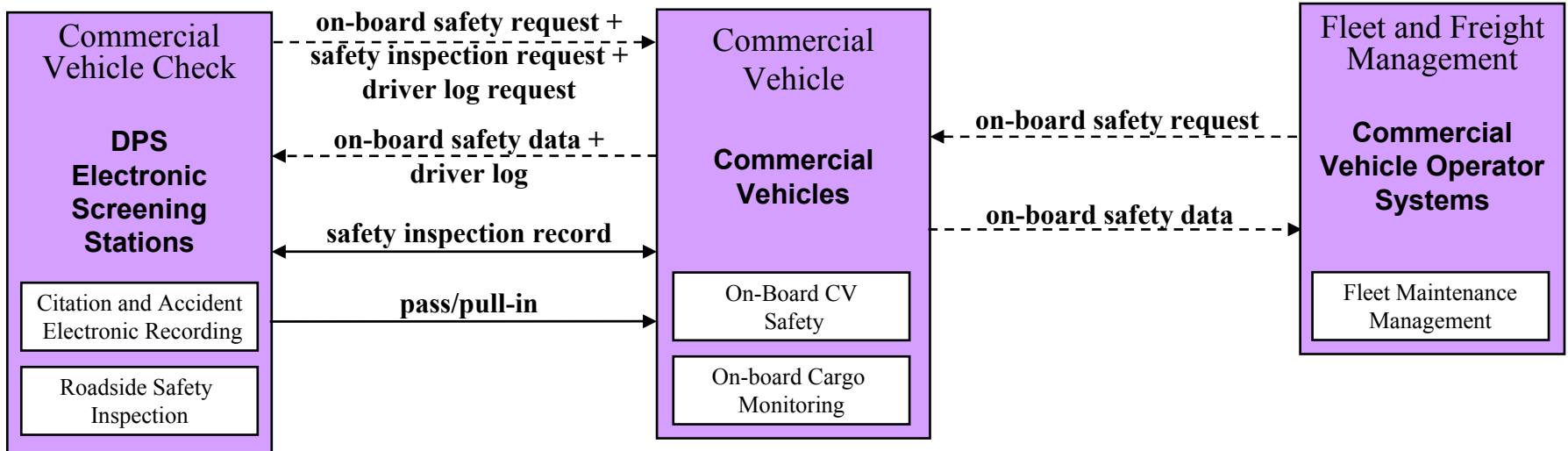

# CVO09 - CVO Fleet Maintenance

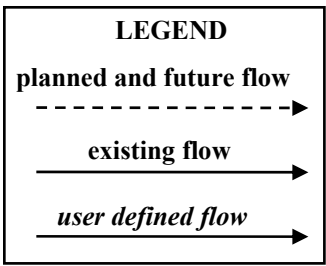
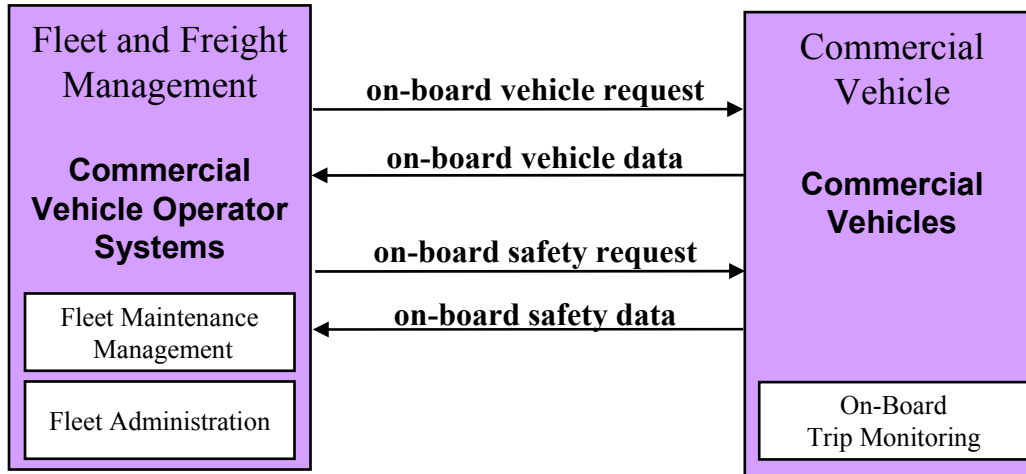

# CVO10 – Commercial Vehicle HAZMAT Management

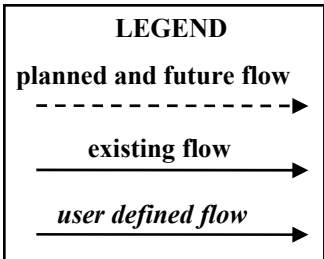
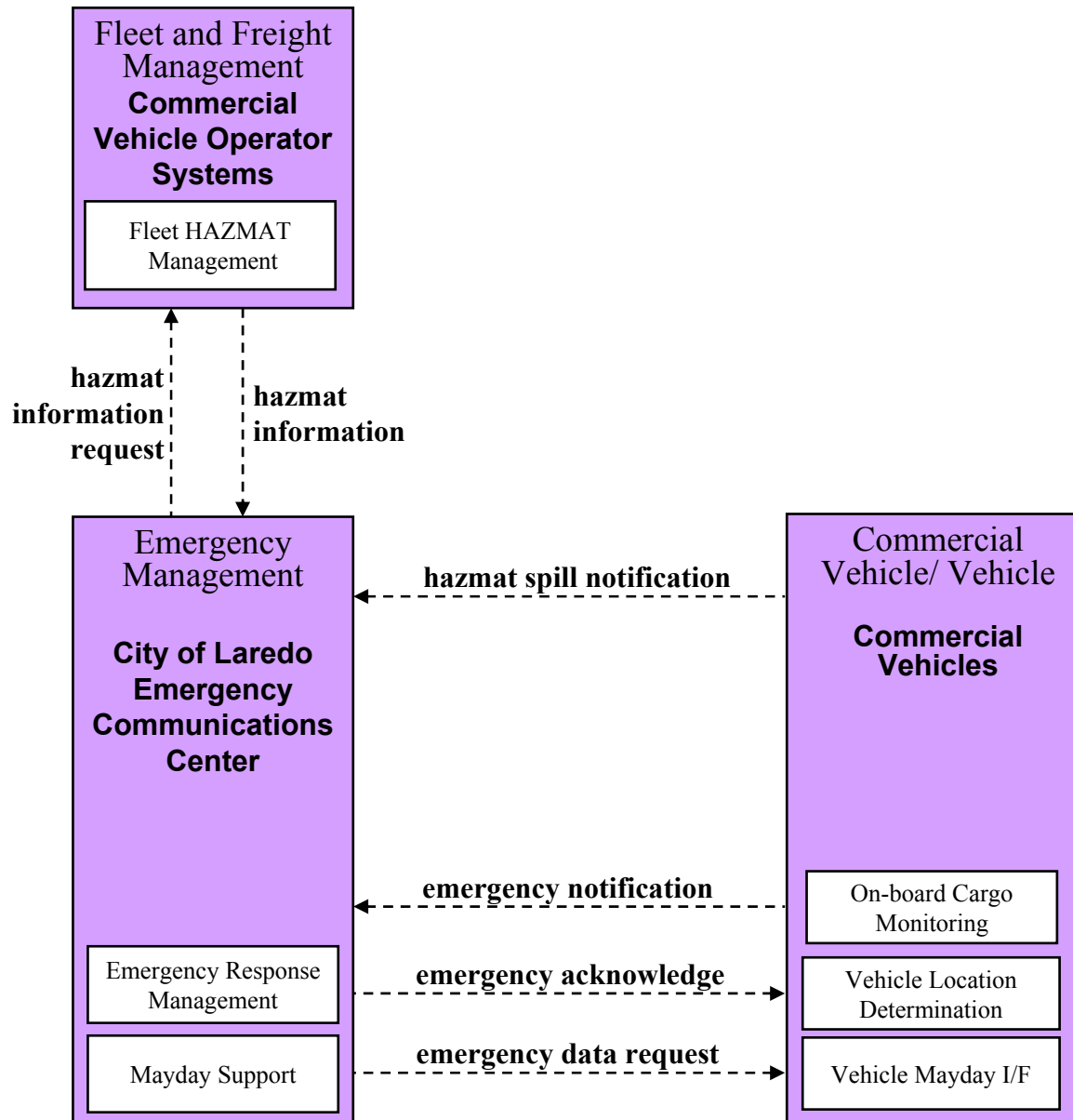

# CVO10 – International Border Rail HAZMAT Management

