

AD1 - ITS Data Mart Statewide Crash Records

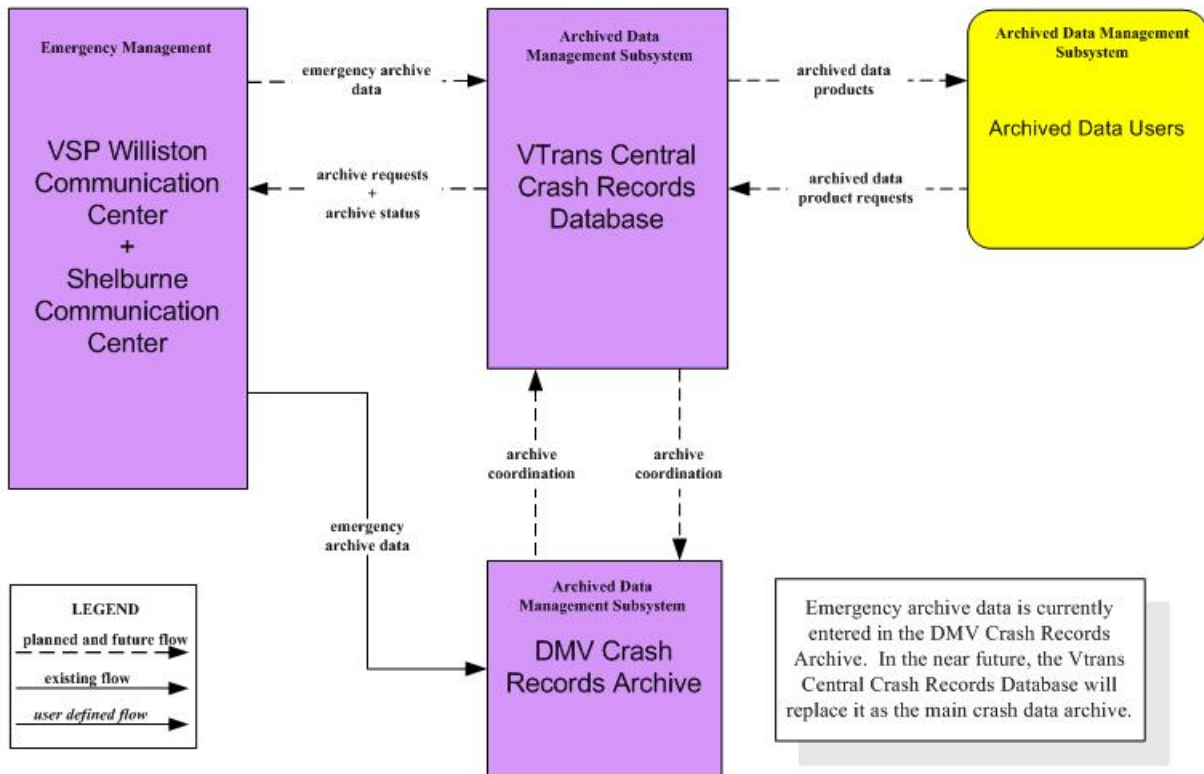

AD2 - ITS Data Warehouse
CCMPO Data Warehouse

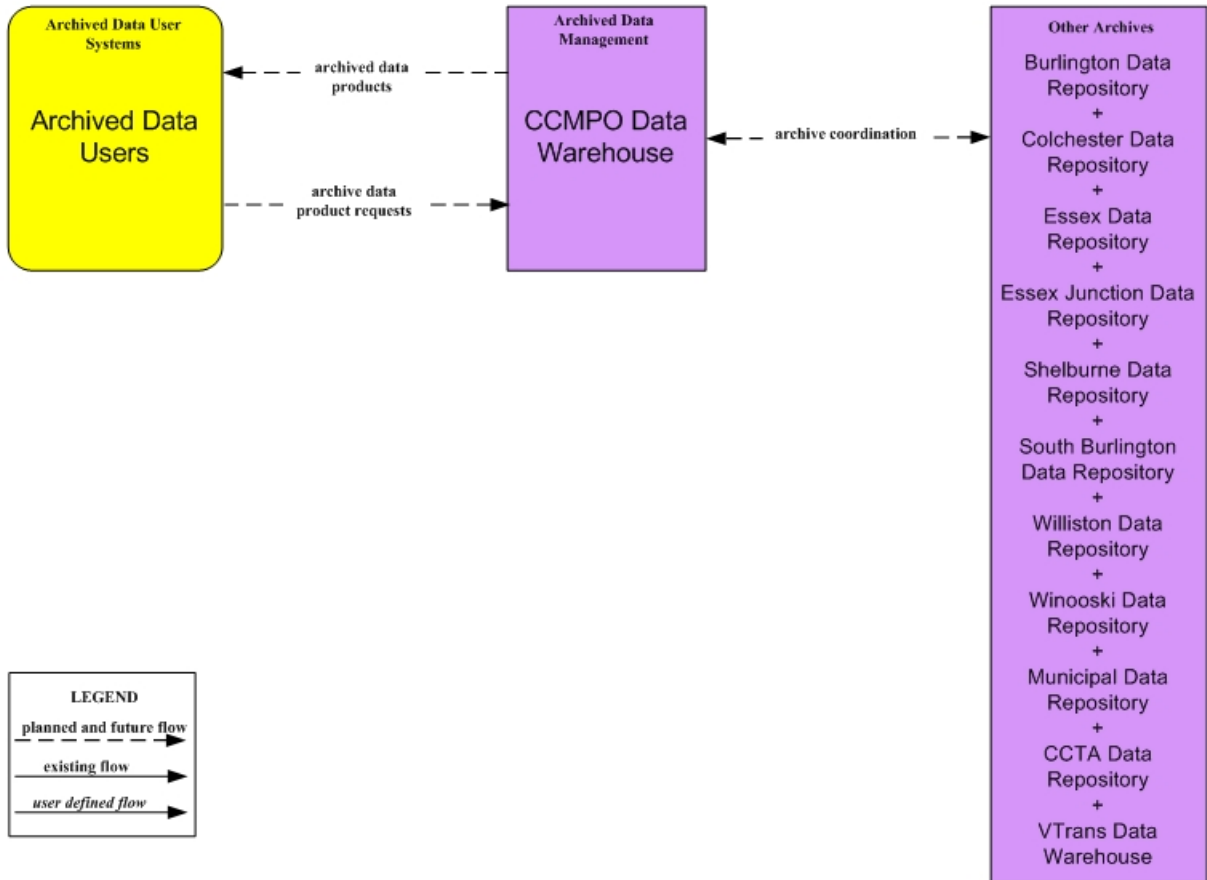

AD2 - ITS Data Warehouse
VTrans Data Warehouse

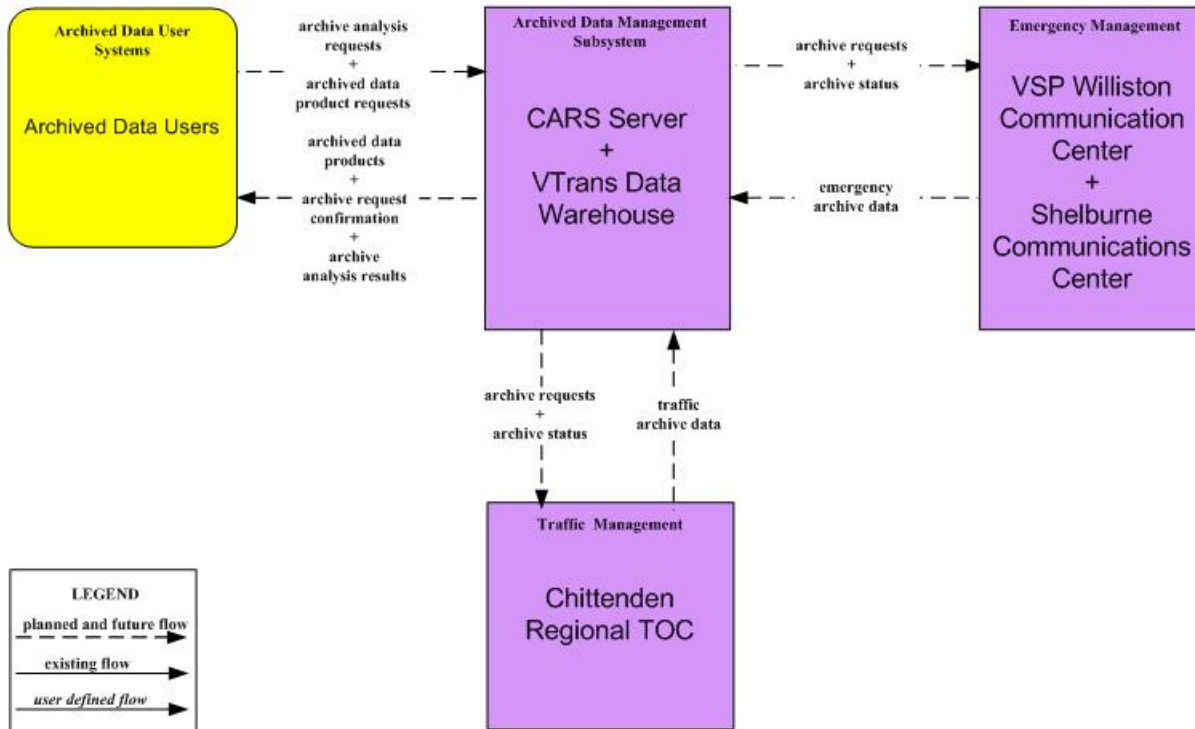

APTS7 – Multimodal Coordination
 CCTA Fixed Route Dispatch – Chittenden Regional TOC and VTrans State TOC

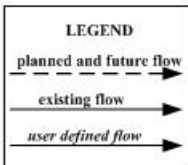
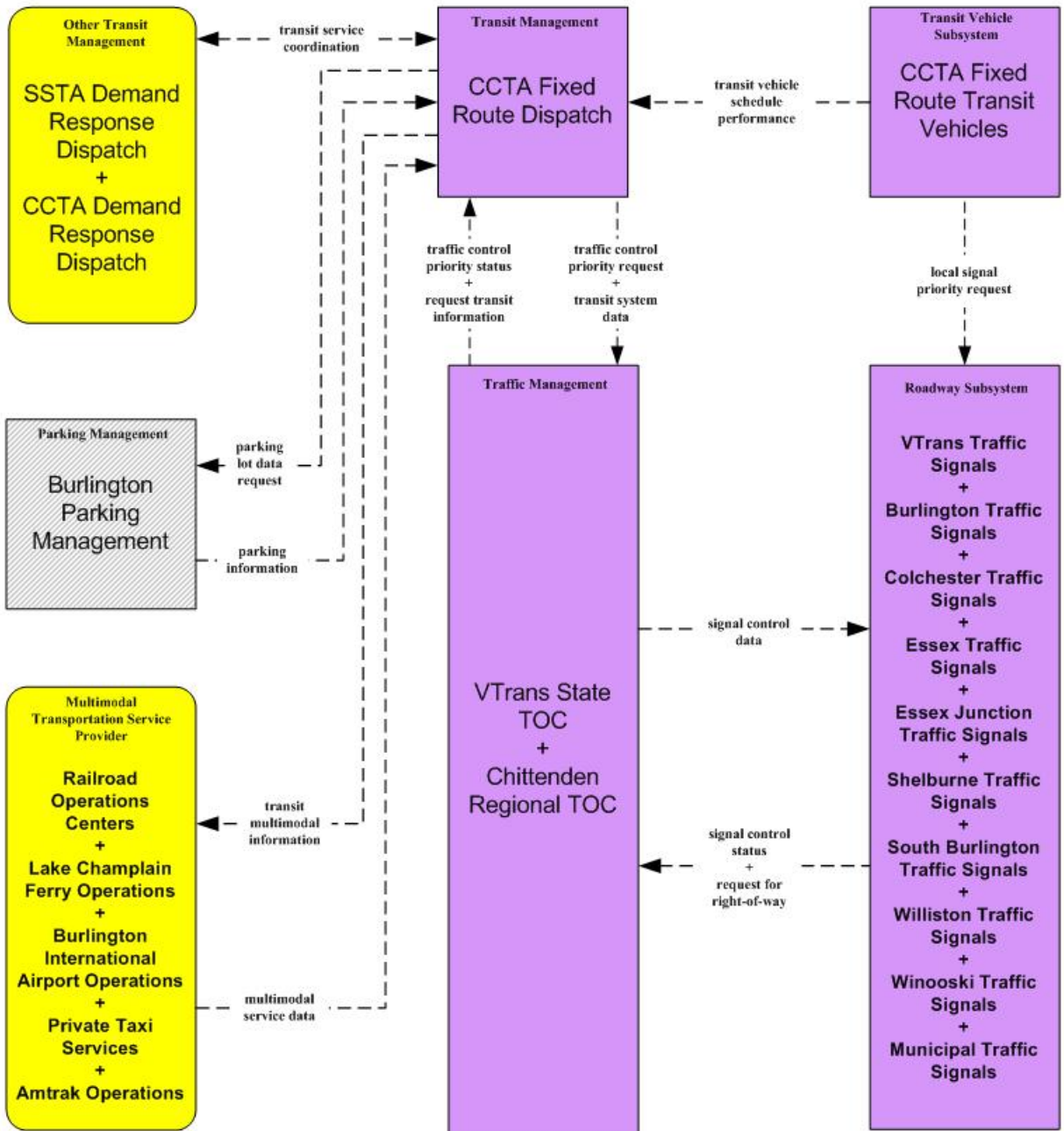

This market package instance is pending creation of the Chittenden Regional TOC. See the other APTS7 instance for details if it is not.

APTS8 - Transit Traveler Information

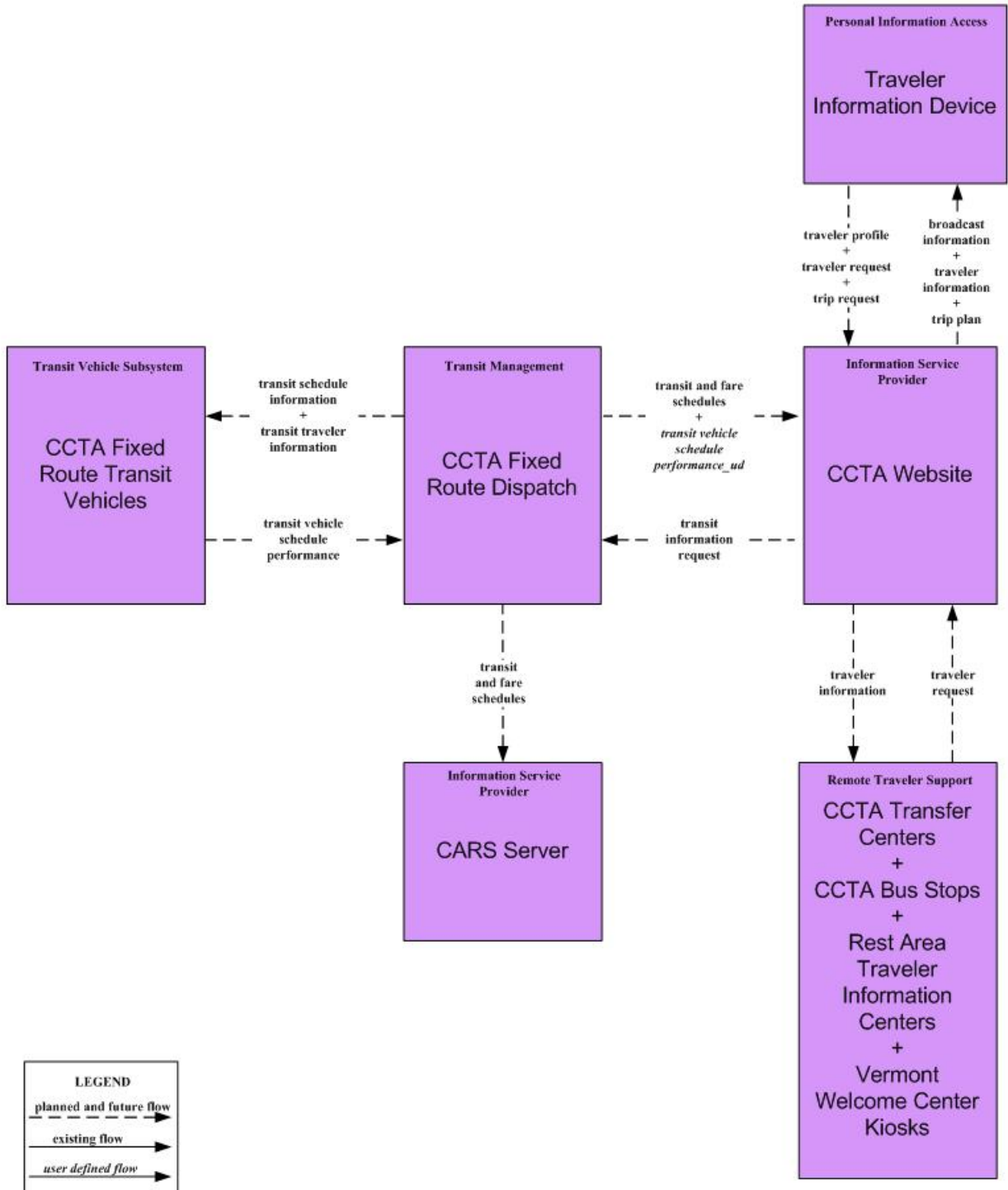

ATIS1 - Broadcast Traveler Information CARS Information System

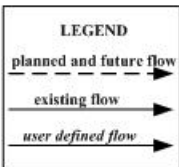
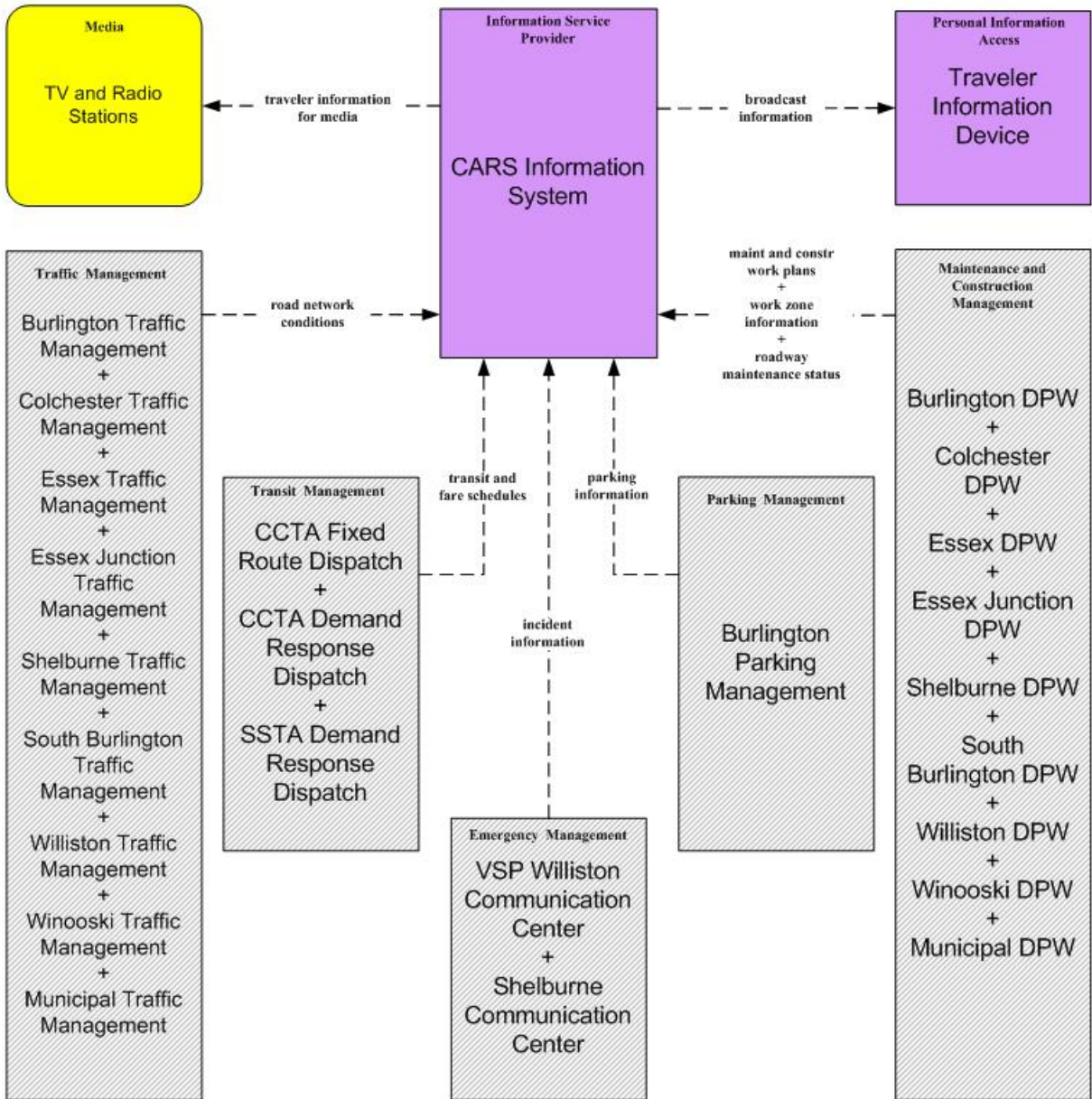

This market package instance is valid if the Chittenden Regional TOC is not created. See the ATIS1 – CARS – Chittenden Regional TOC instance for details if it is.

ATIS1 - Broadcast Traveler Information
 CARS Information System – Chittenden Regional TOC

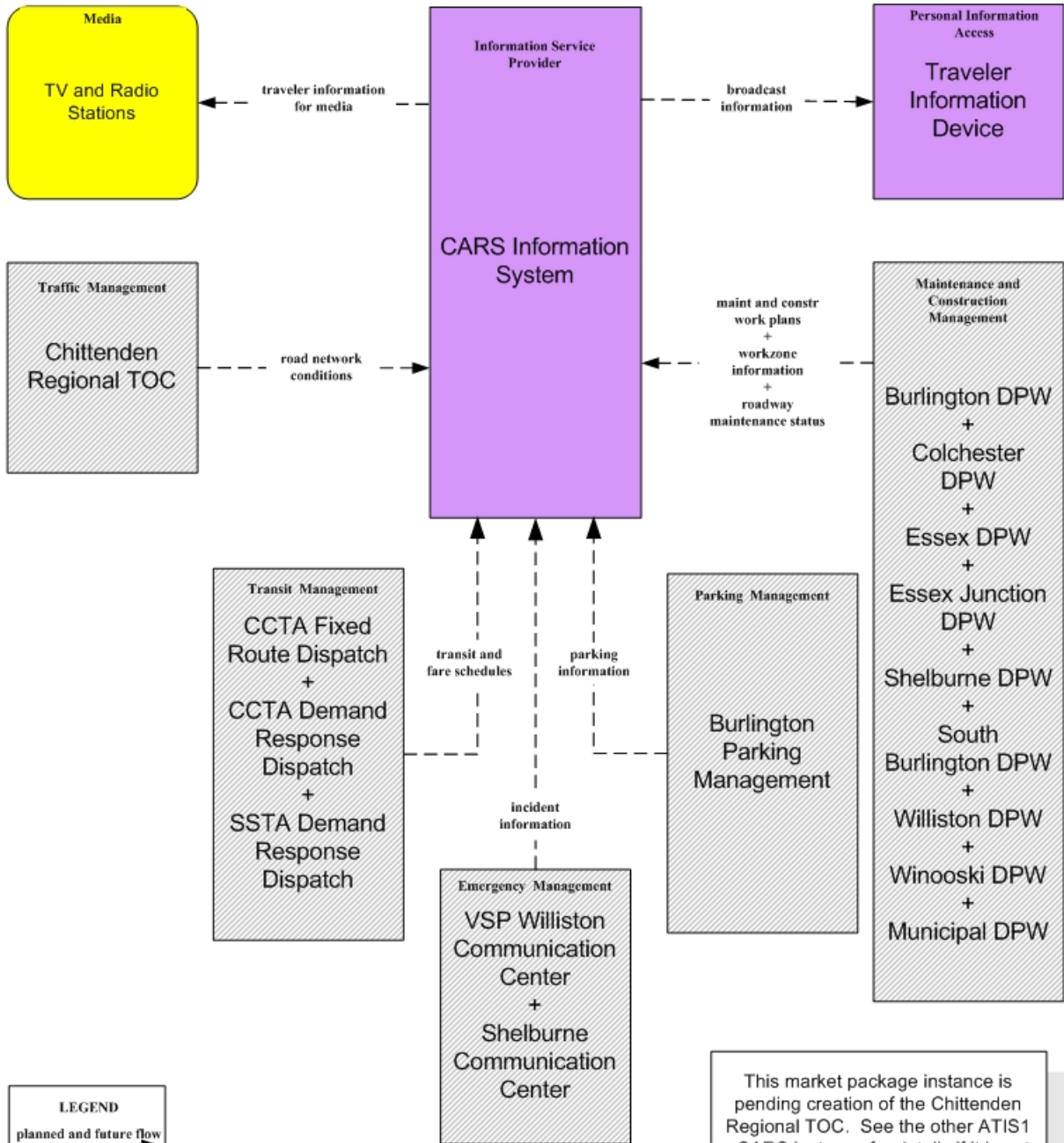

LEGEND

- planned and future flow
- existing flow
- user defined flow

This market package instance is pending creation of the Chittenden Regional TOC. See the other ATIS1 – CARS instance for details if it is not.

ATIS2 – Interactive Traveler Information Vermont Travel Planner

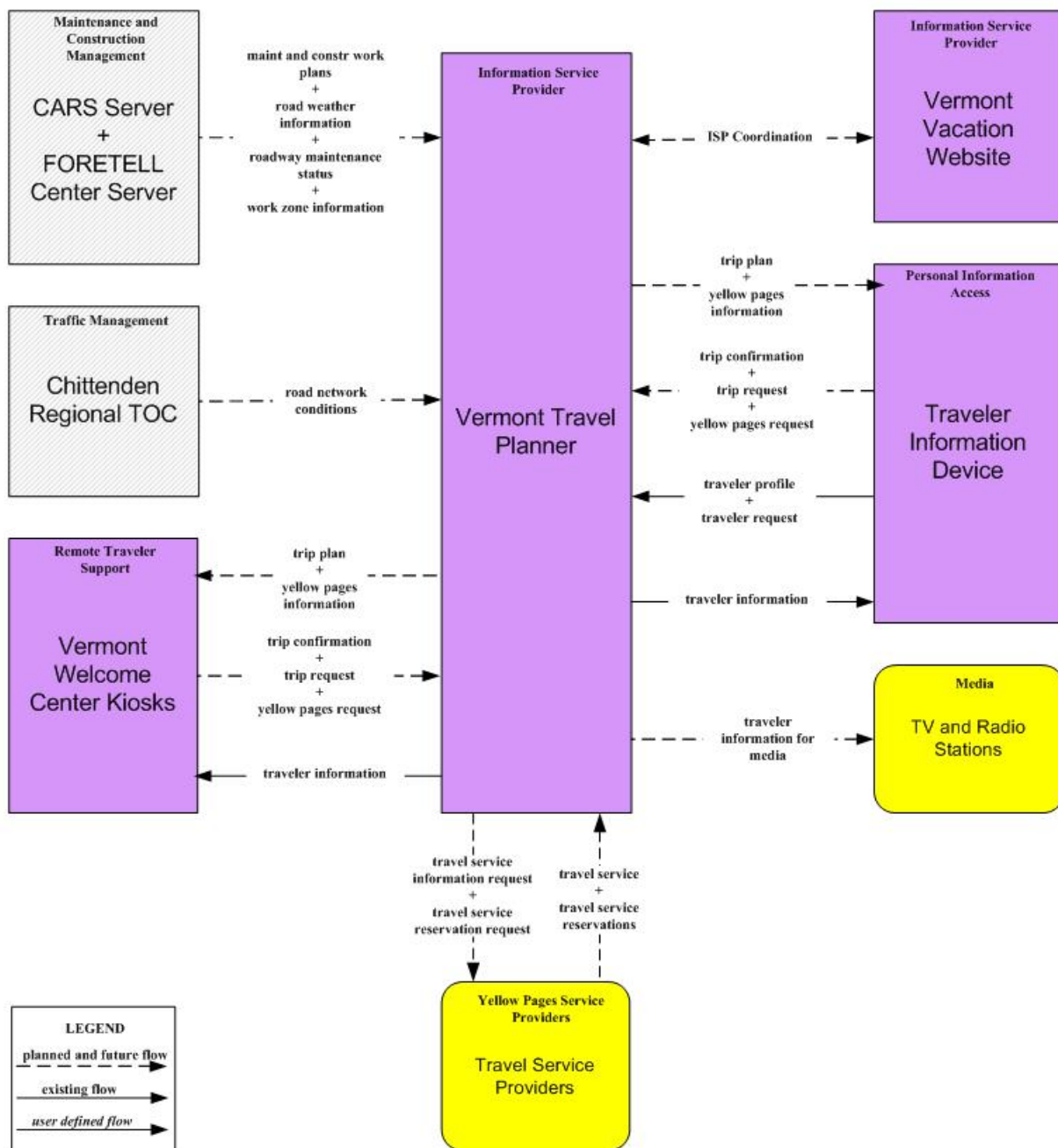

ATMS01 - Network Surveillance Burlington Traffic Management

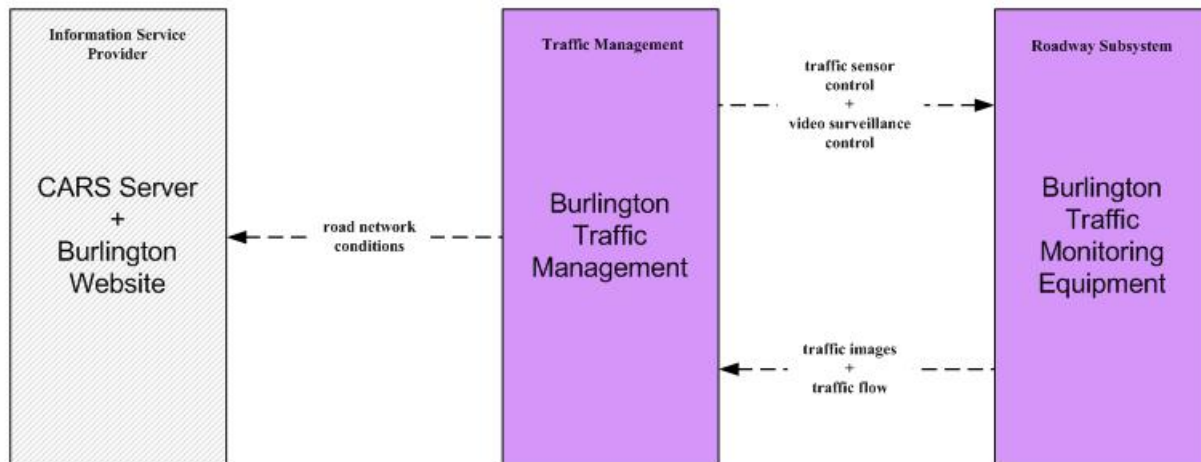

LEGEND

planned and future flow →

existing flow →

user defined flow →

ATMS01 - Network Surveillance Colchester Traffic Management

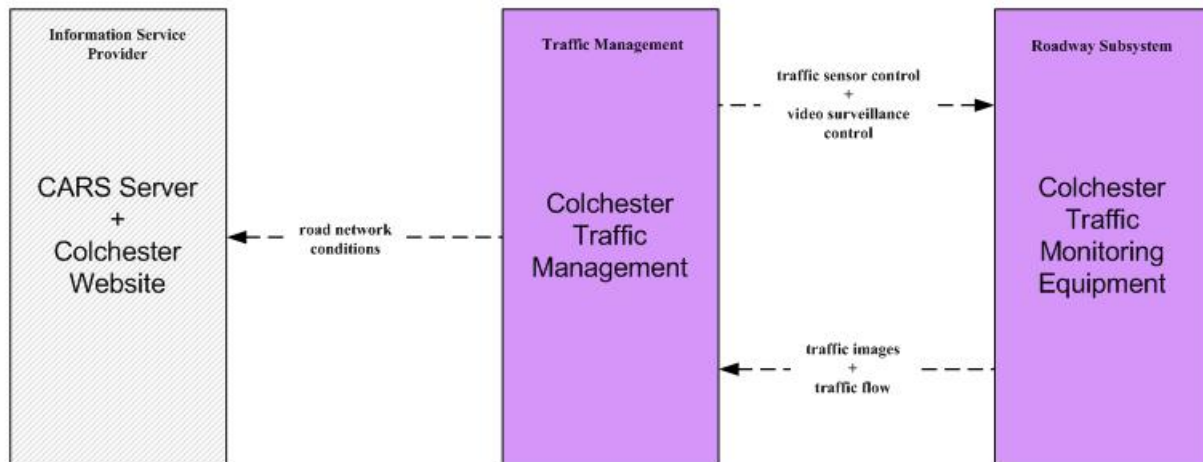

LEGEND

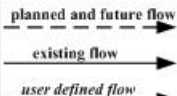

ATMS01 - Network Surveillance Essex Traffic Management

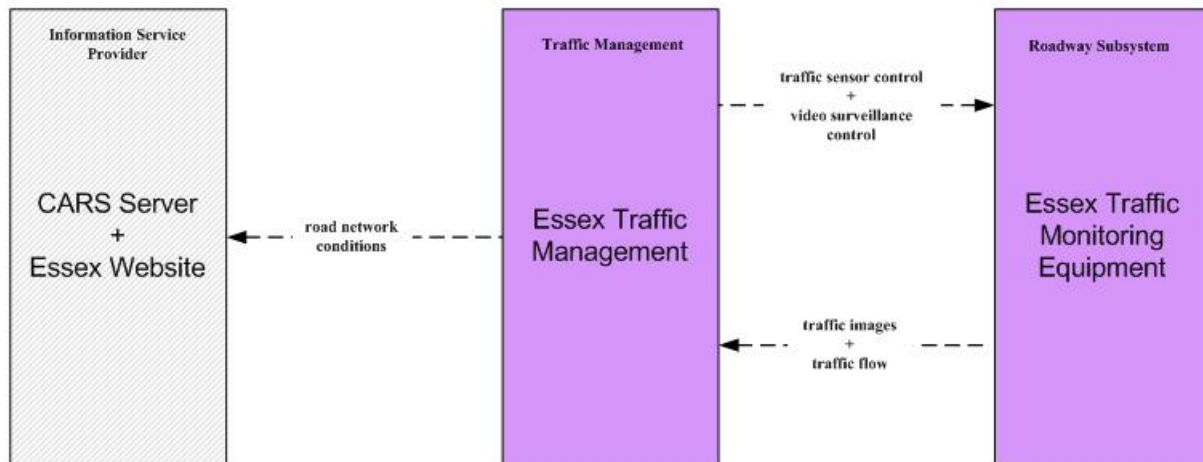

LEGEND

planned and future flow →

existing flow →

user defined flow →

ATMS01 - Network Surveillance Essex Junction Traffic Management

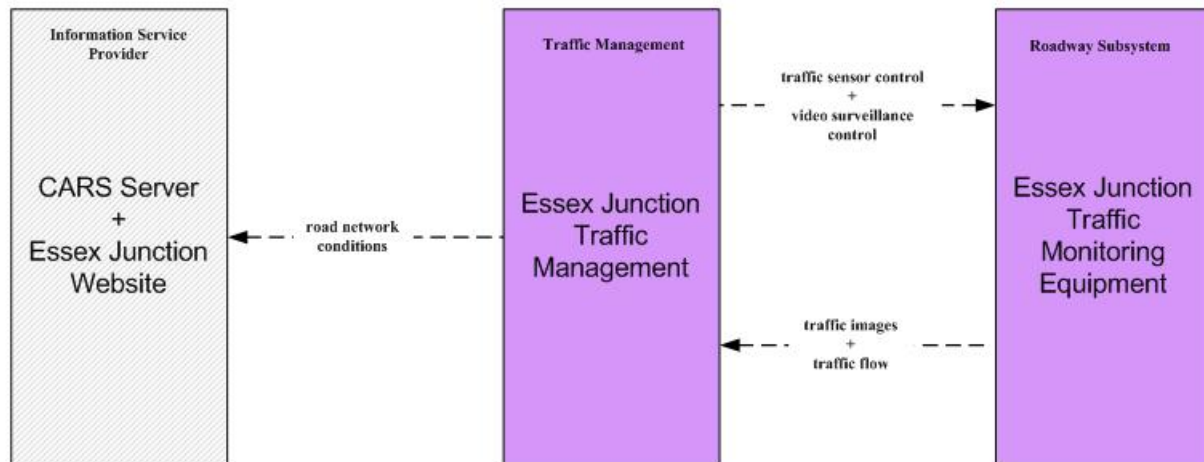

LEGEND

planned and future flow

existing flow

user defined flow

ATMS01 - Network Surveillance
Municipal Traffic Management

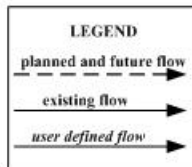
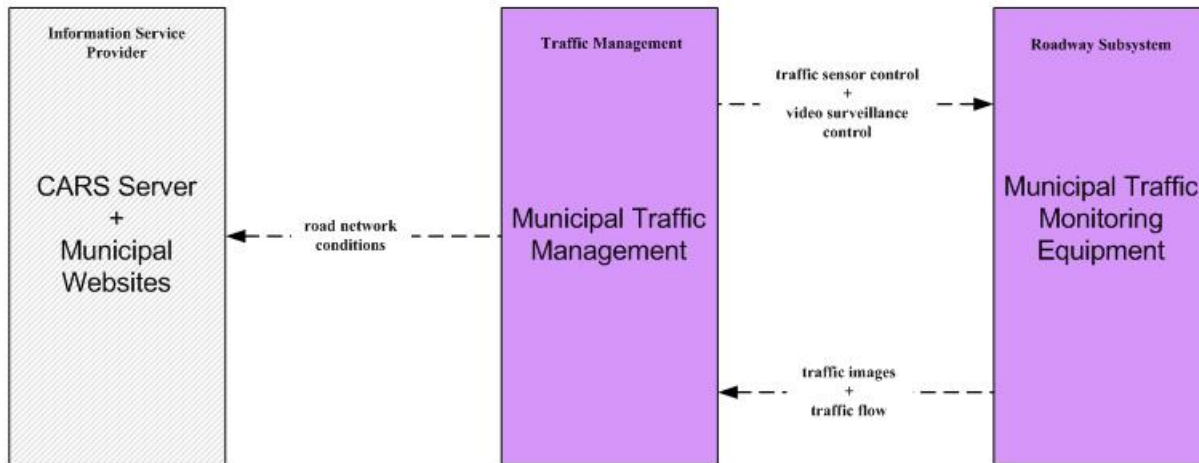

ATMS01 - Network Surveillance
Shelburne Traffic Management

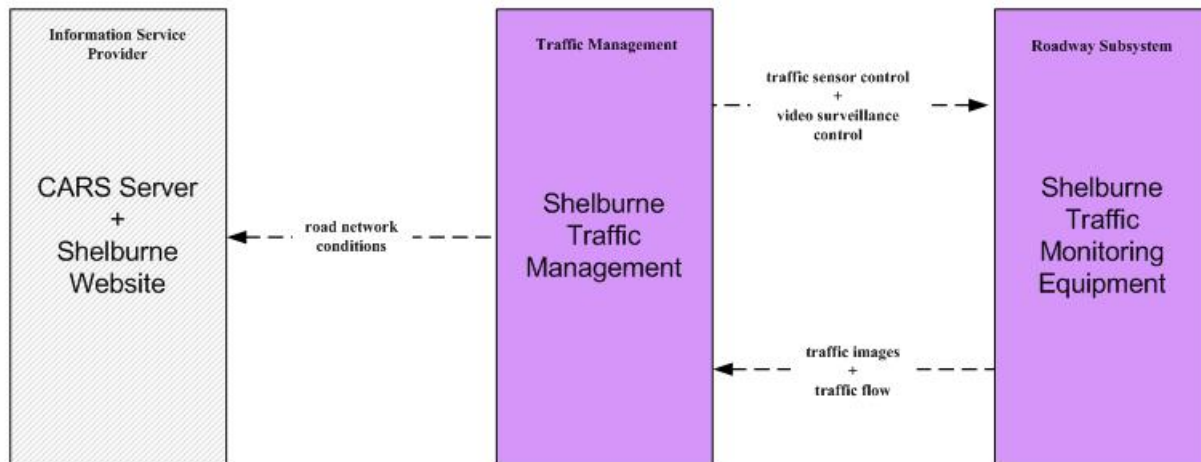

LEGEND

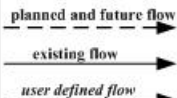

ATMS01 - Network Surveillance South Burlington Traffic Management

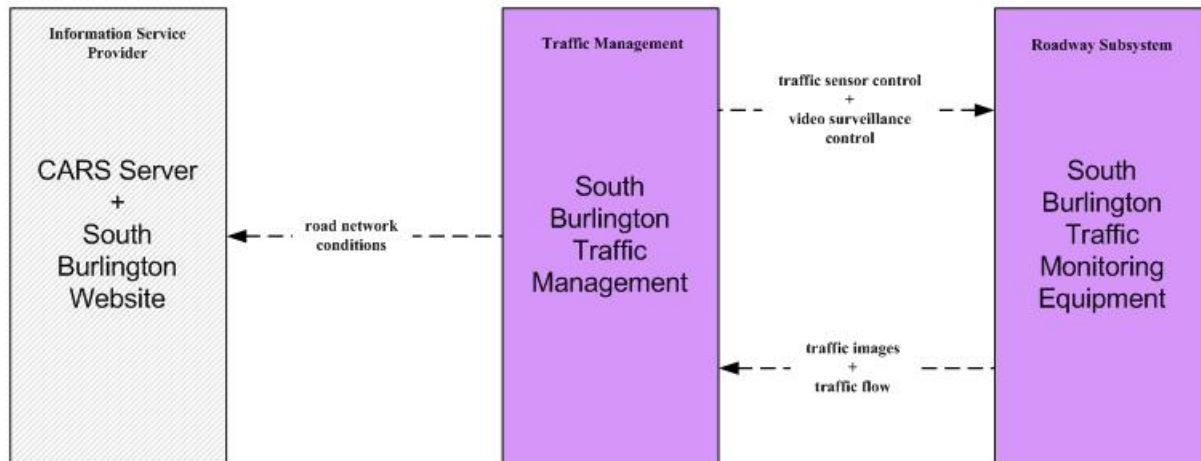

LEGEND

planned and future flow →

existing flow →

user defined flow →

ATMS01 - Network Surveillance Williston Traffic Management

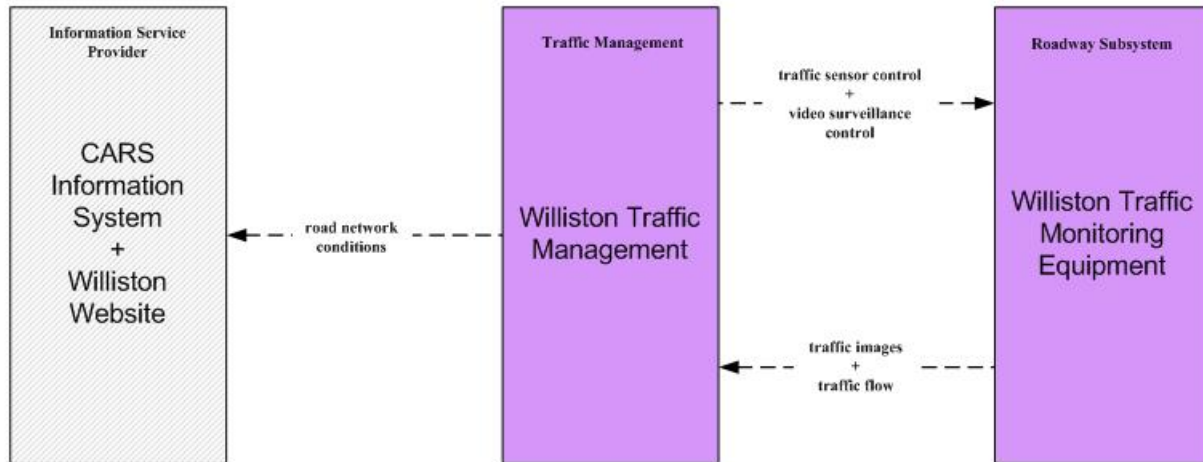

LEGEND

planned and future flow

existing flow

user defined flow

ATMS01 - Network Surveillance Winooski Traffic Management

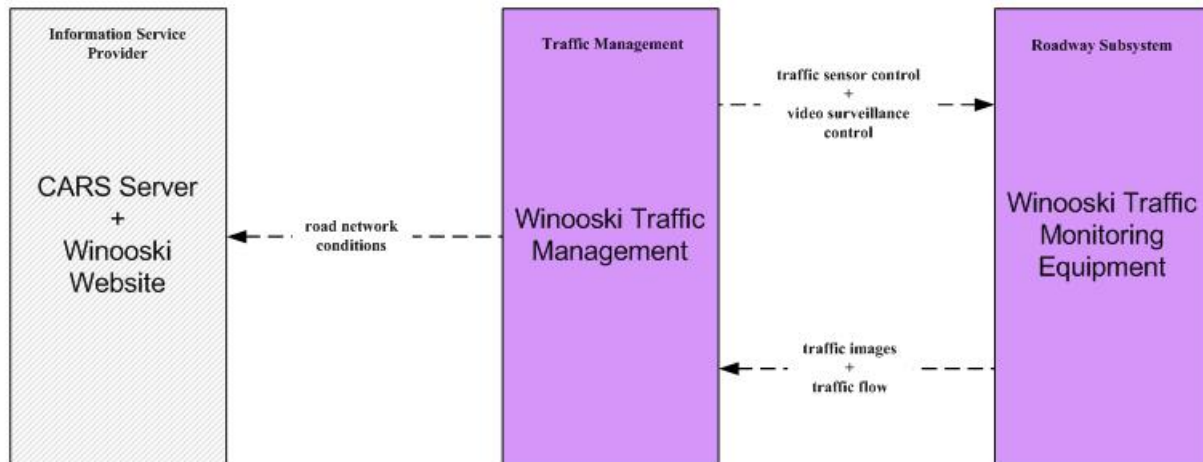

LEGEND

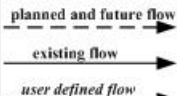

ATMS07 – Regional Traffic Control
VTrans State TOC/Chittenden Regional TOC

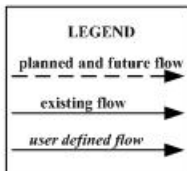
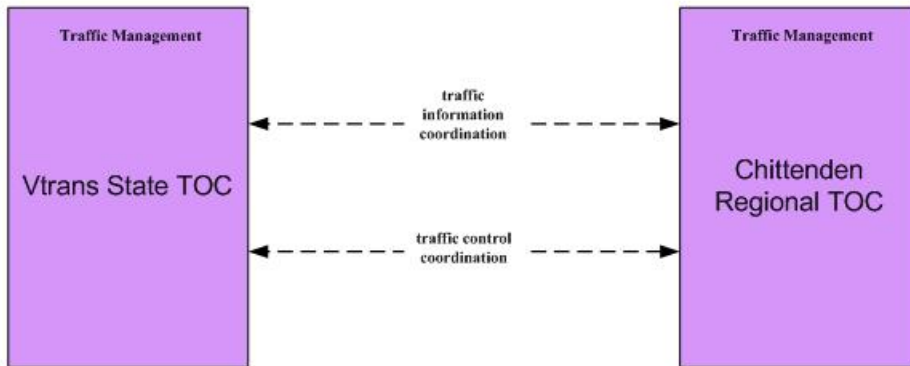

ATMS08 – Incident Management
Chittenden Regional TOC

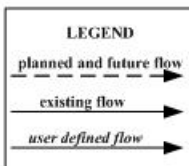
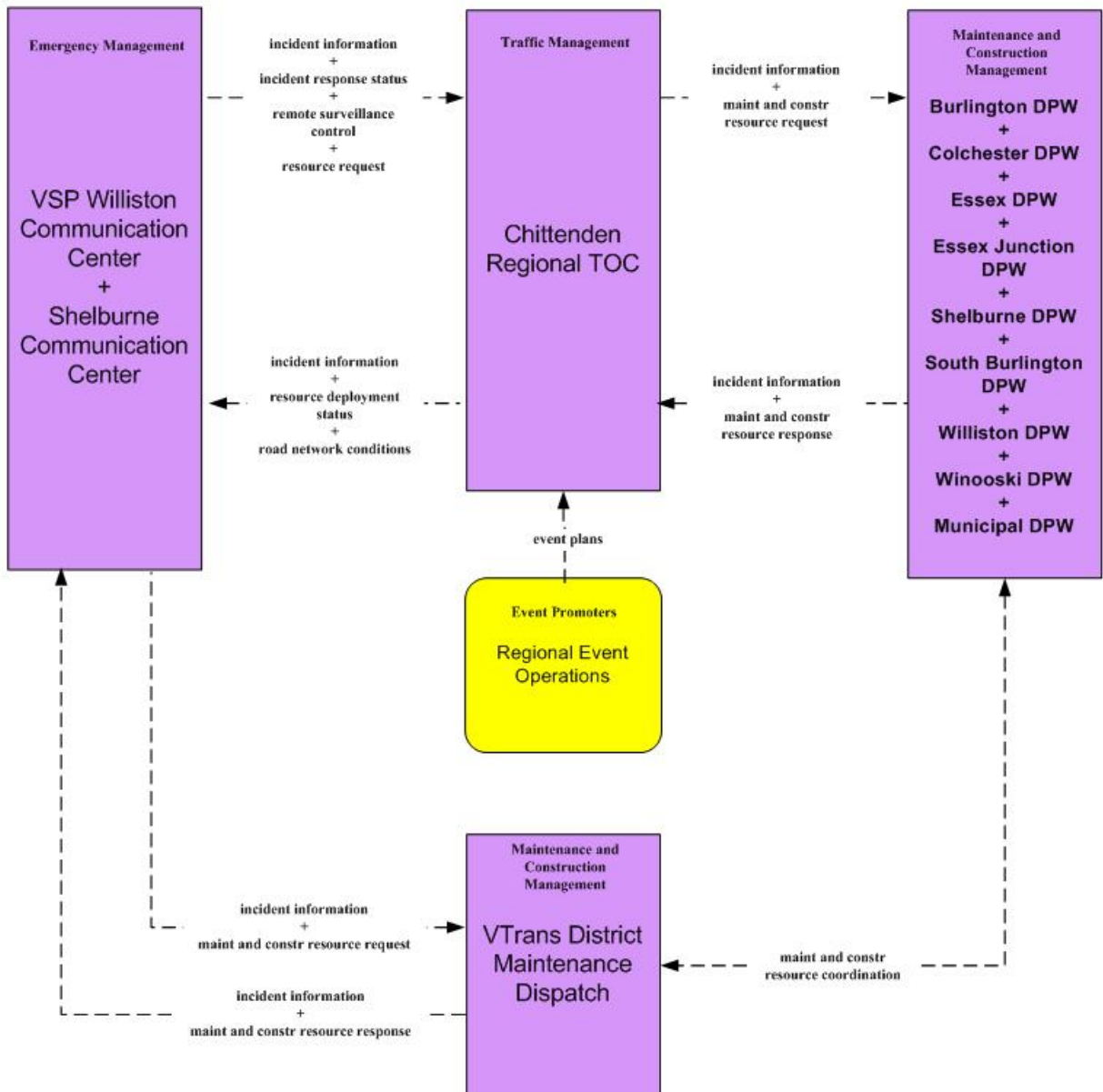

ATMS08 – Incident Management
VTrans State TOC

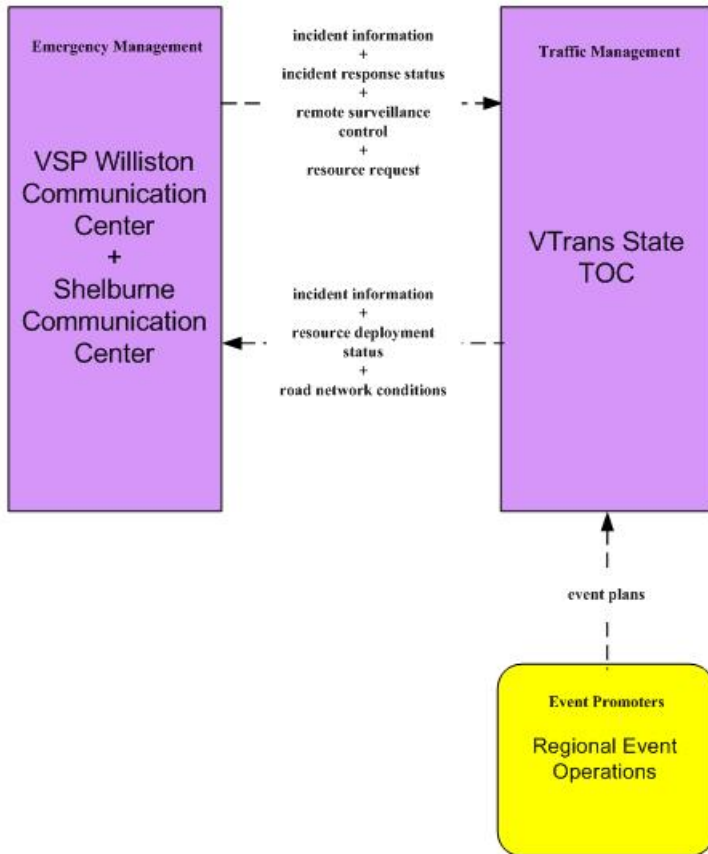

EMO2 – Emergency Routing

2 of 2 – Emergency Management

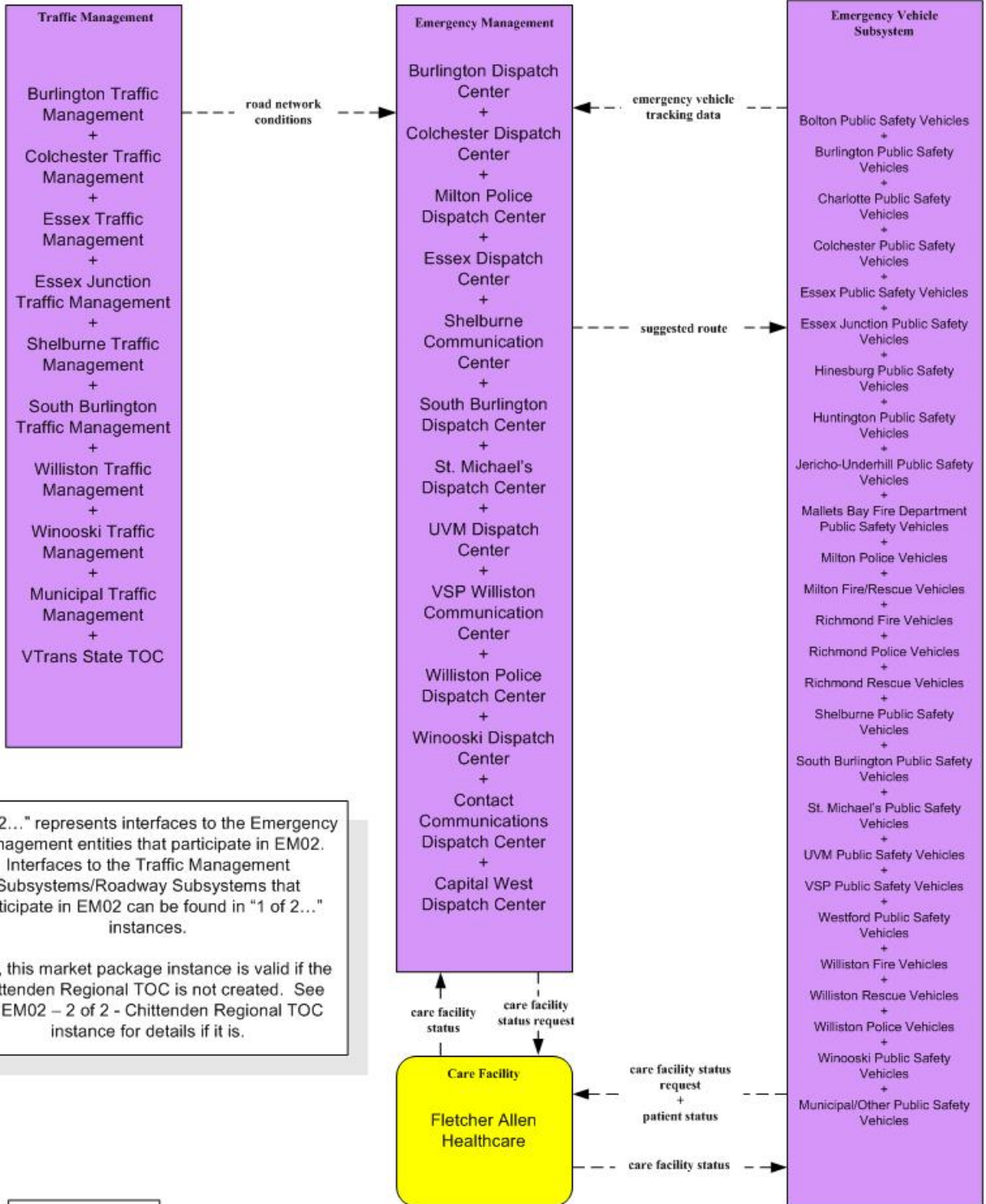

"2 of 2..." represents interfaces to the Emergency Management entities that participate in EM02. Interfaces to the Traffic Management Subsystems/Roadway Subsystems that participate in EM02 can be found in "1 of 2..." instances.

Also, this market package instance is valid if the Chittenden Regional TOC is not created. See the EM02 – 2 of 2 - Chittenden Regional TOC instance for details if it is.

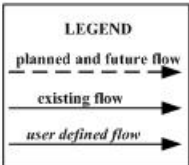

EMO2 – Emergency Routing VTrans

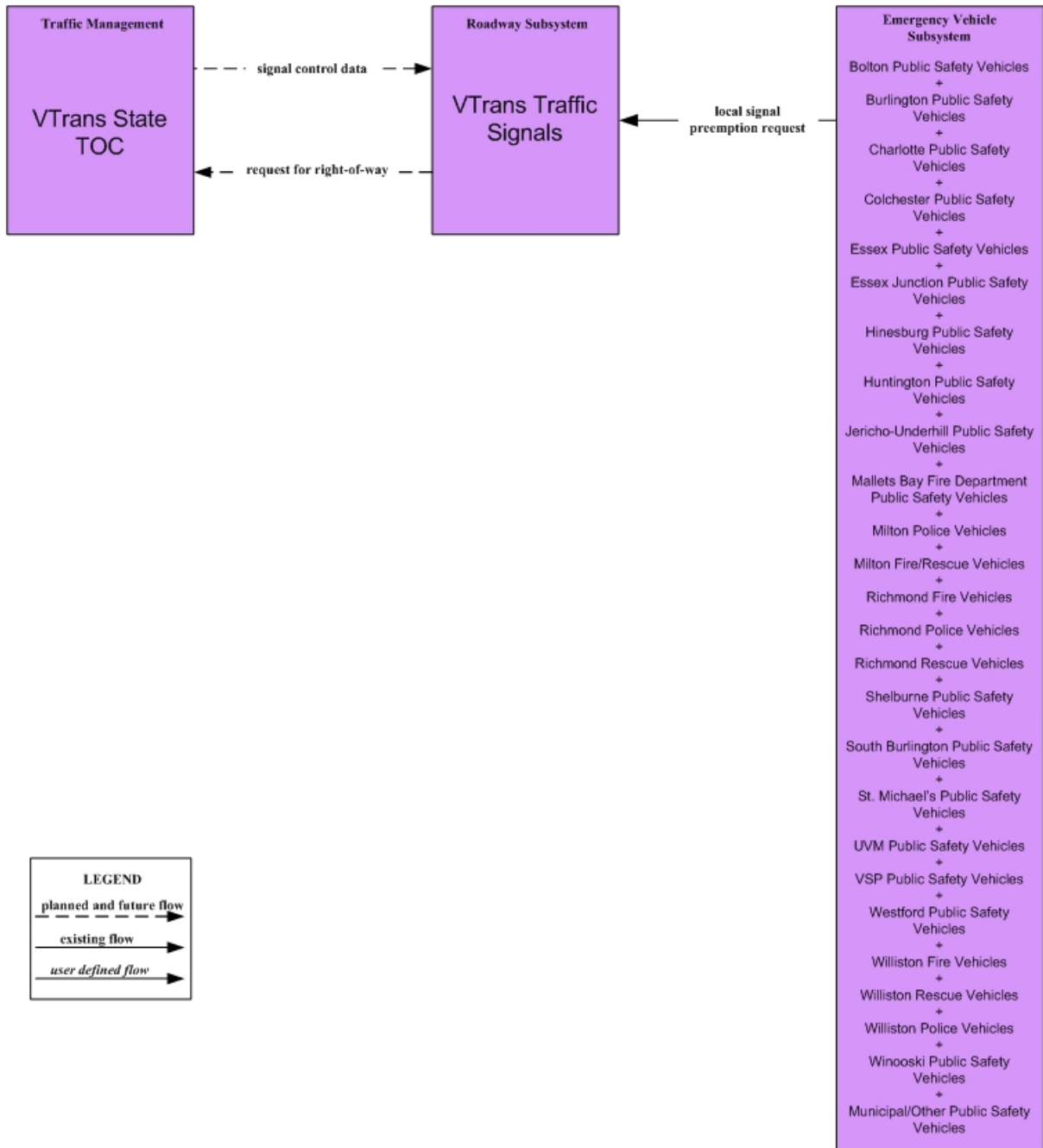

EMO6 – Wide Area Alert
Vermont Statewide EOC & VSP Headquarters

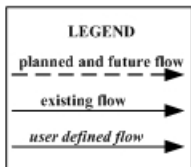
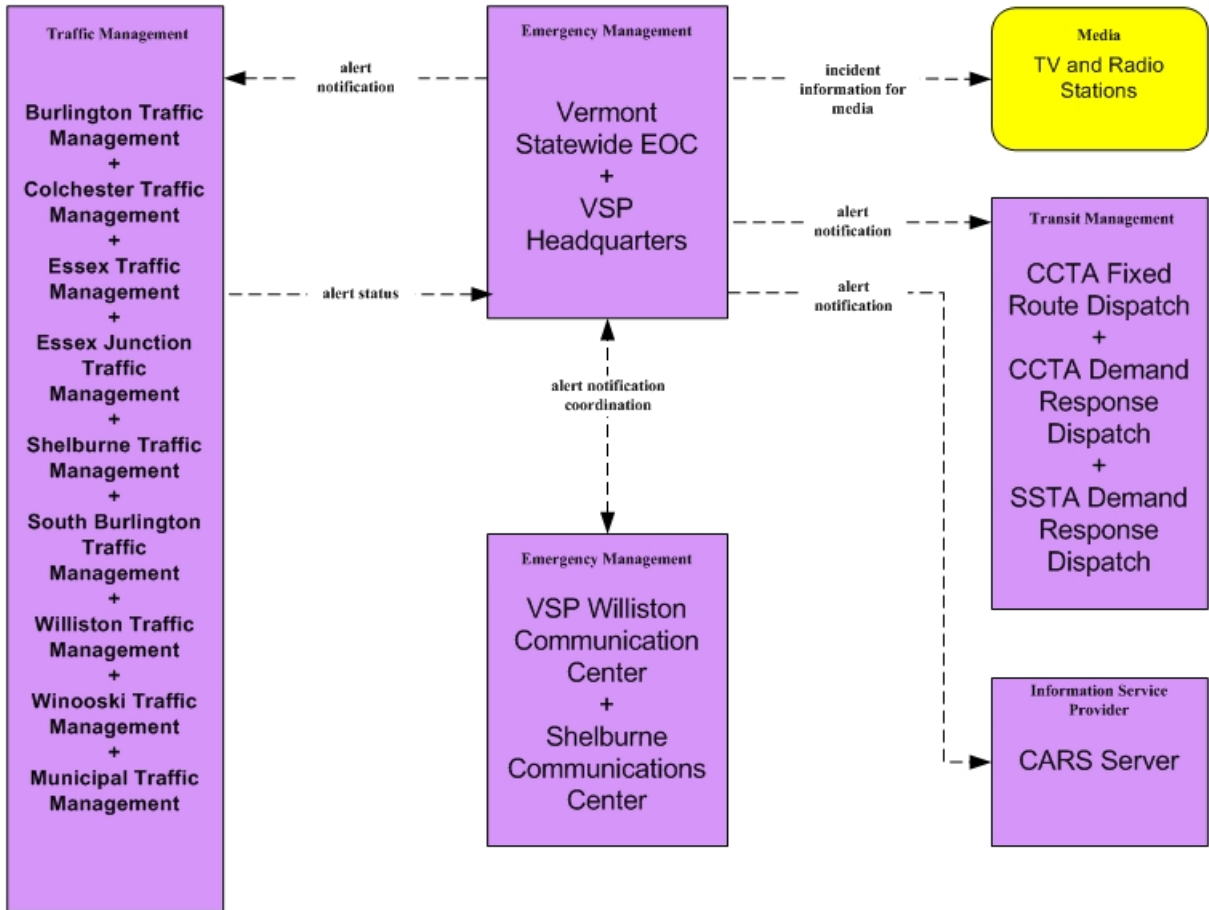

EMO6 – Wide Area Alert
 Vermont Statewide EOC & VSP Headquarters – Chittenden Regional TOC

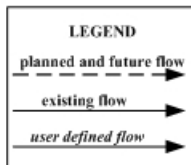
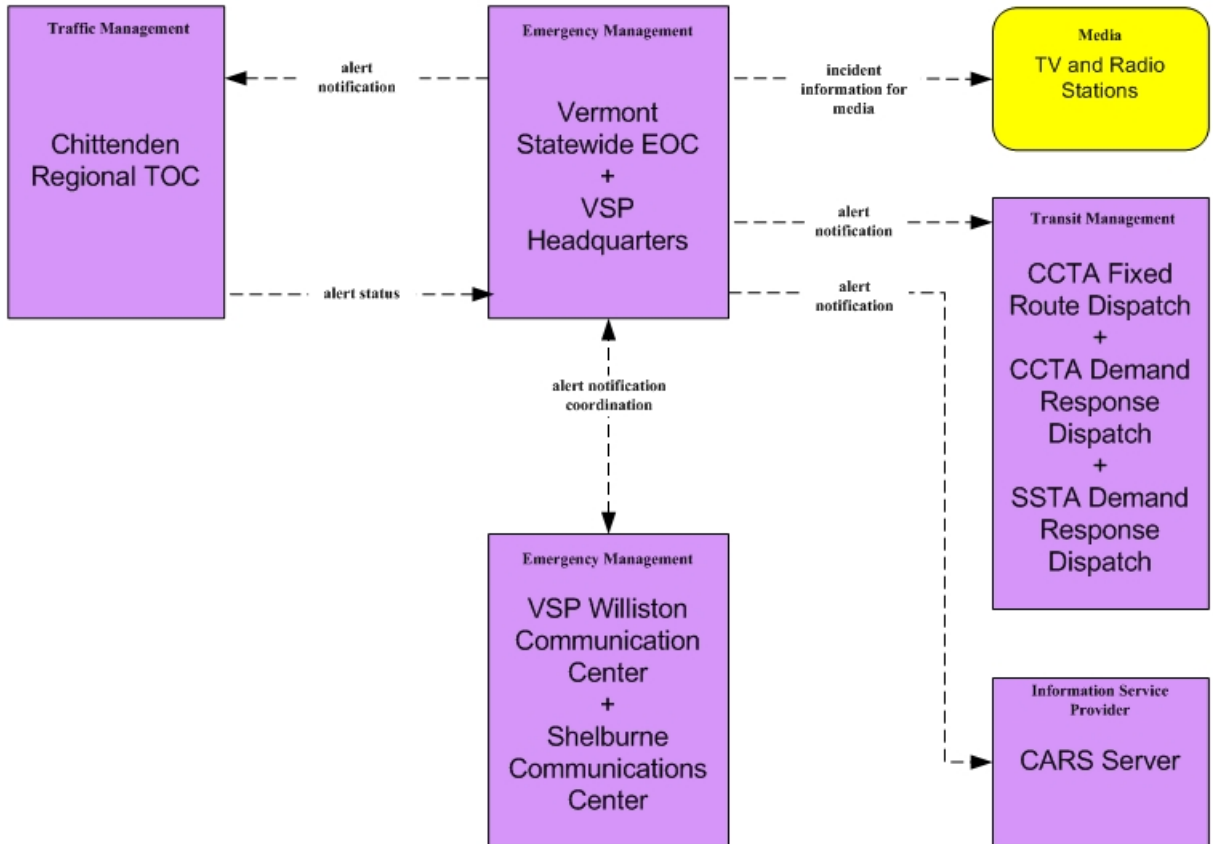

MC04 - Weather Information Processing and Distribution
CARS

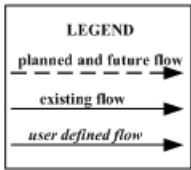
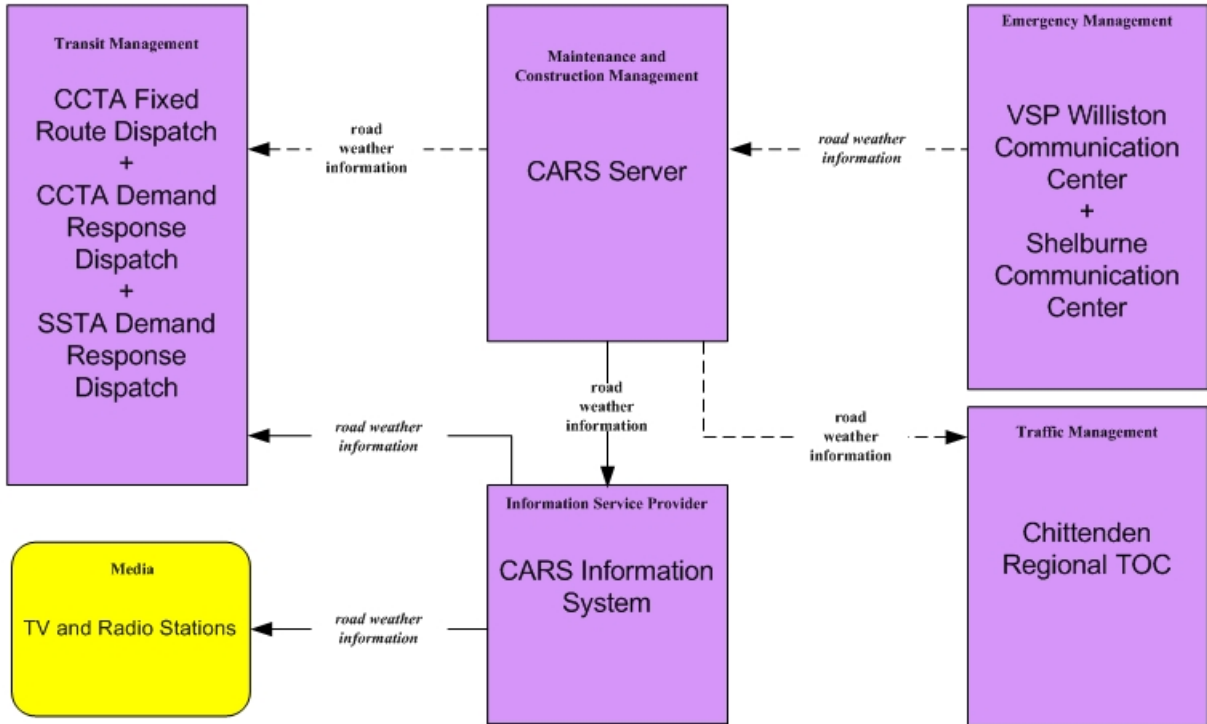

MC04 – Weather Information Processing and Distribution
Chittenden Regional TOC

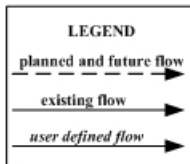
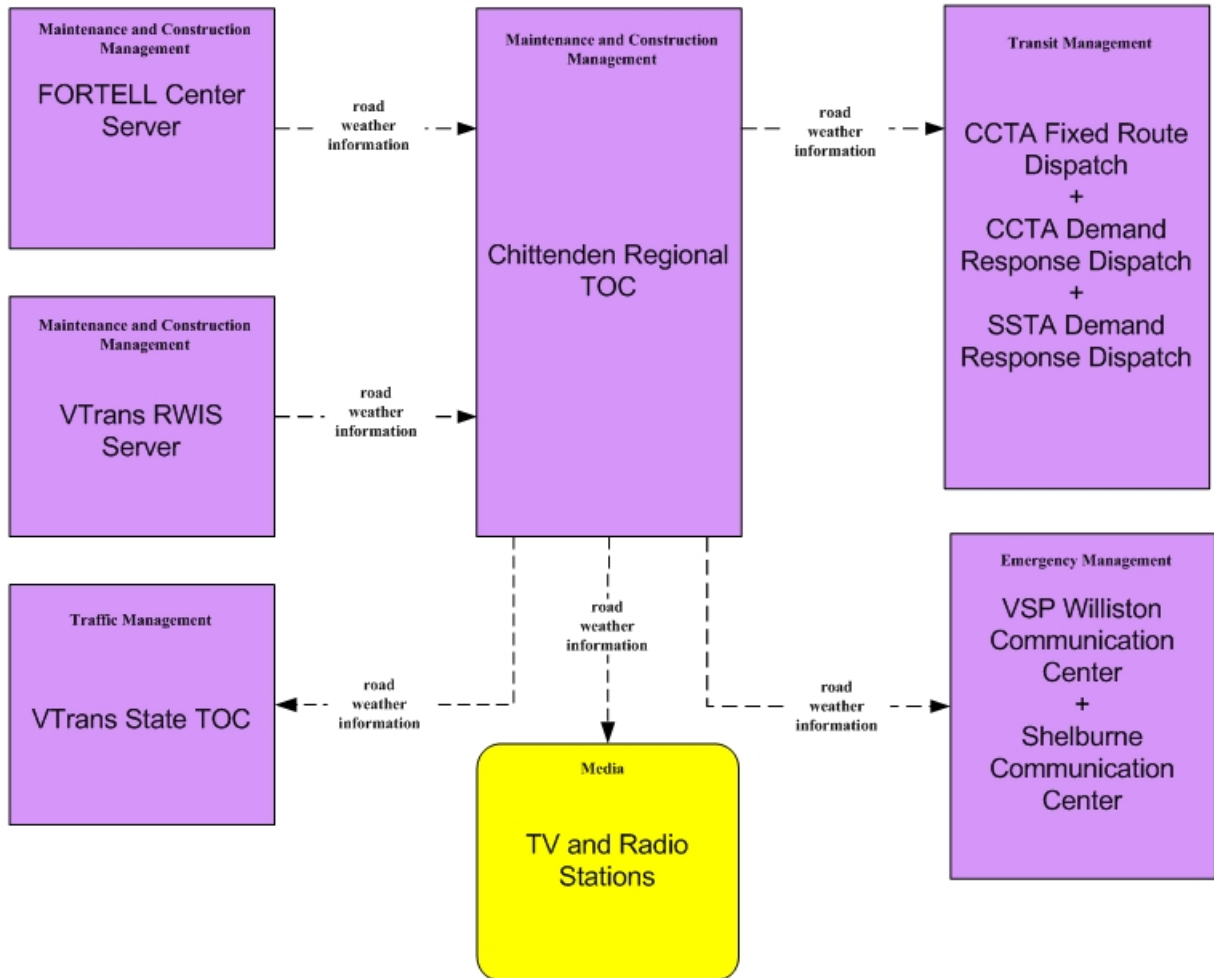

MC06 - Winter Maintenance
VTrans District Maintenance Dispatch

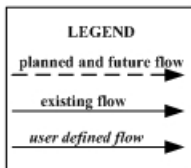
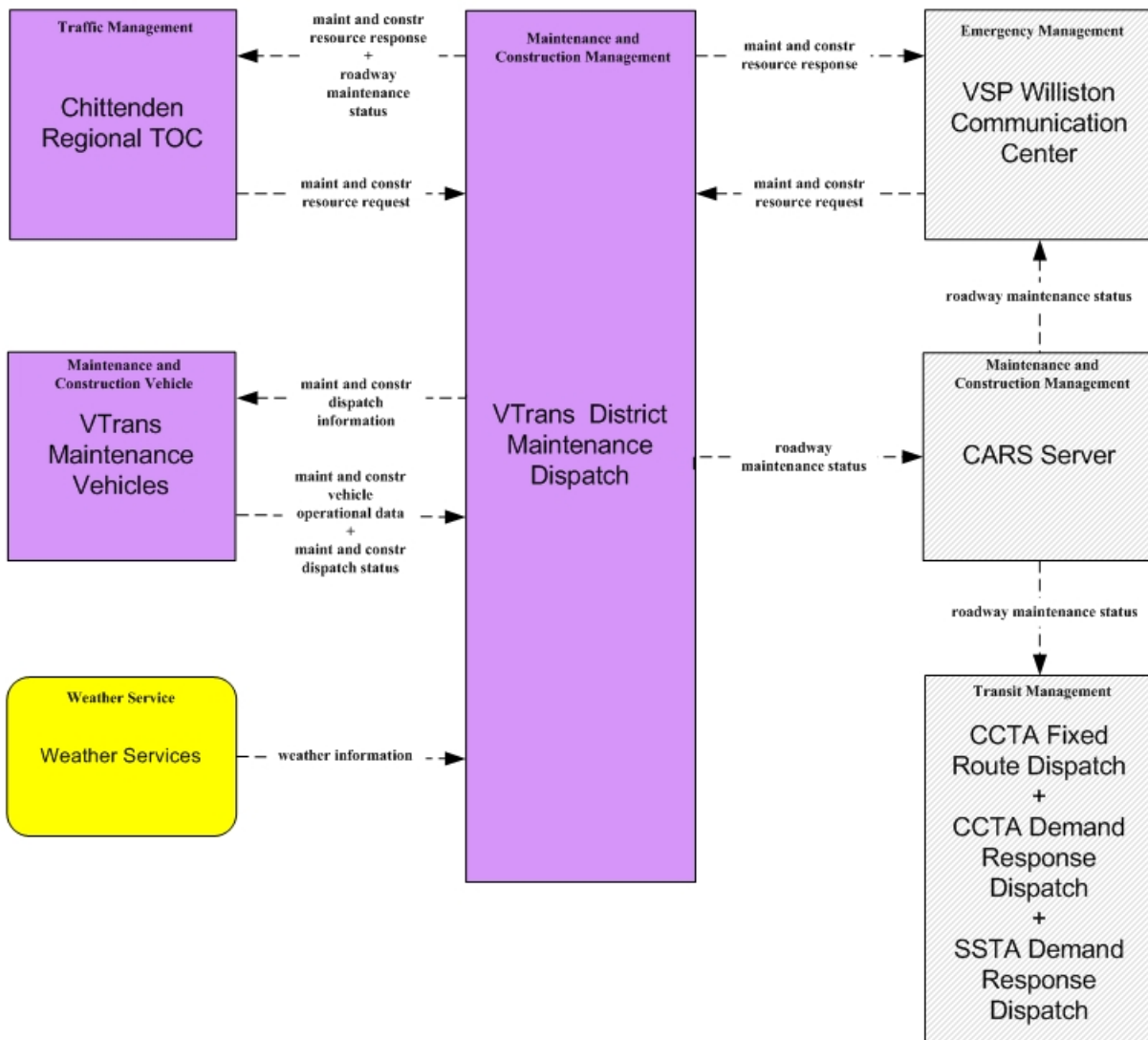

MC08 - Work Zone Management Burlington DPW

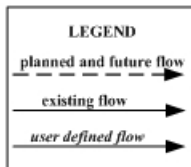
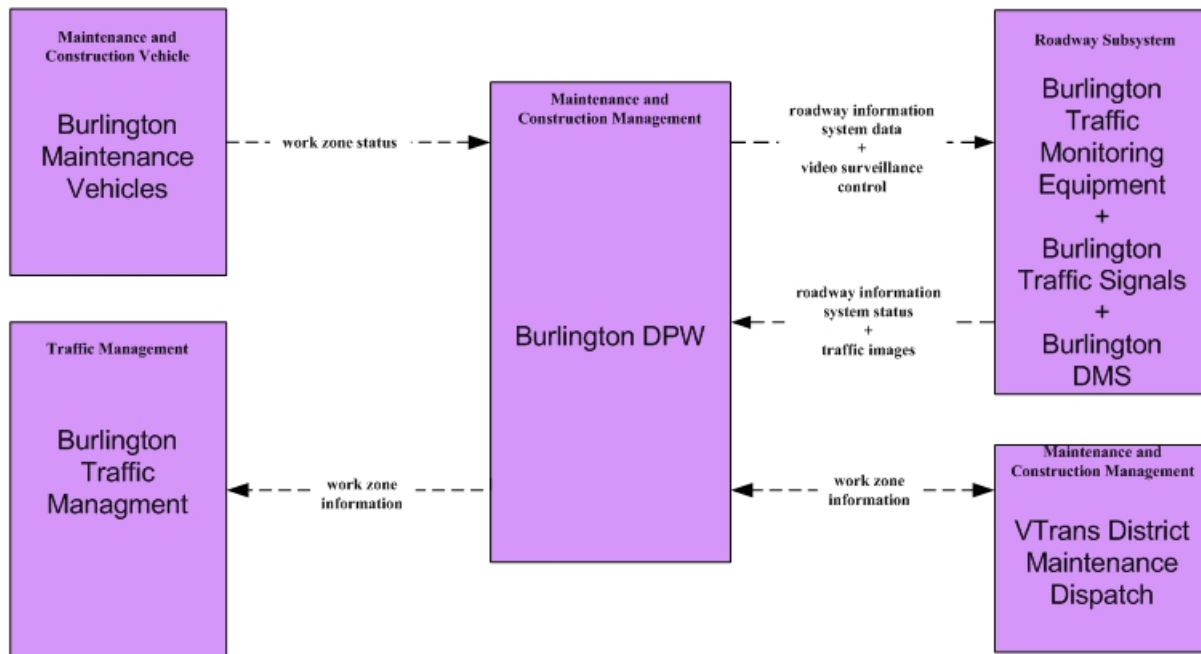

MC08 - Work Zone Management
Colchester DPW

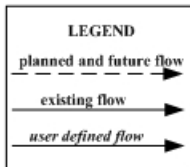
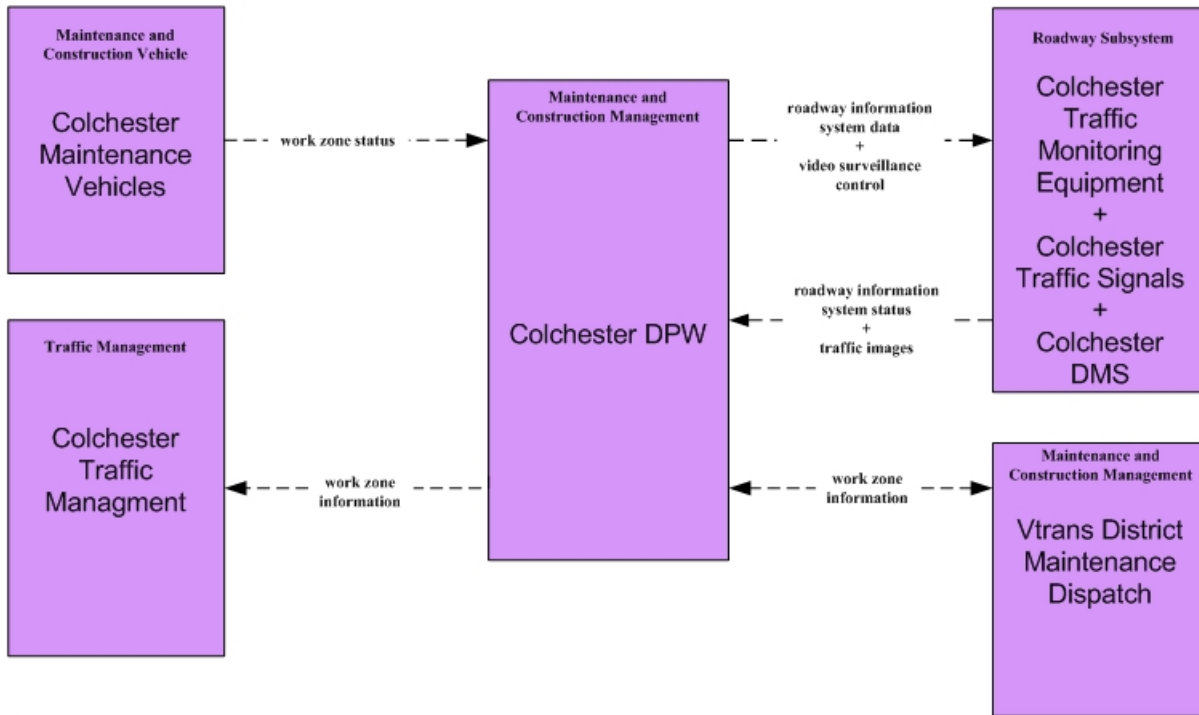

MC08 - Work Zone Management
Essex DPW

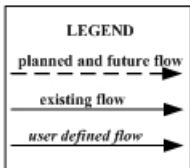
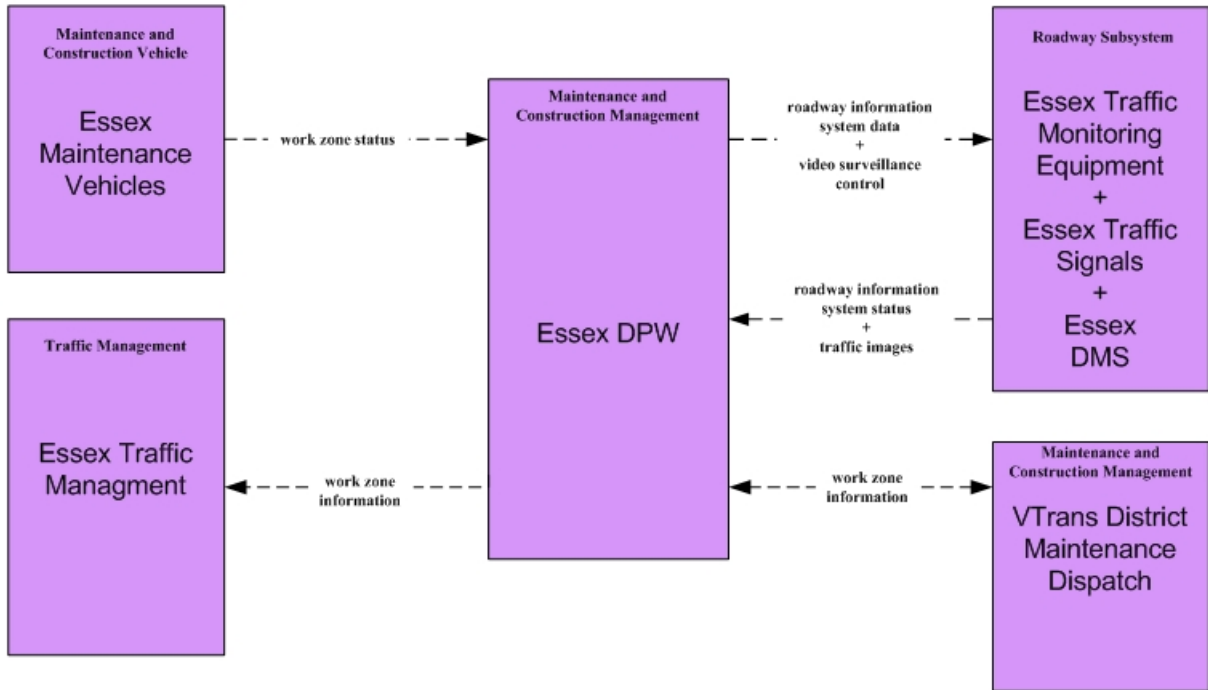

MC08 - Work Zone Management
Essex Junction DPW

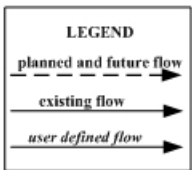
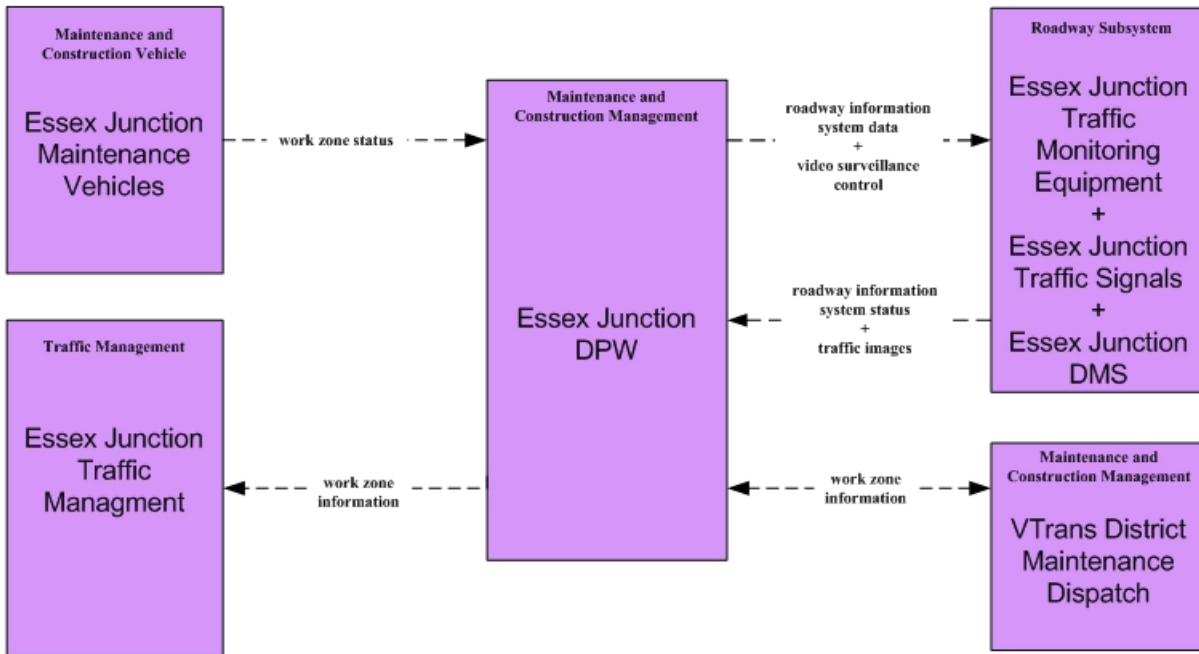

MC08 - Work Zone Management
Municipal DPW

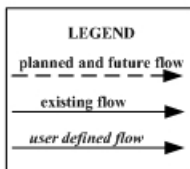
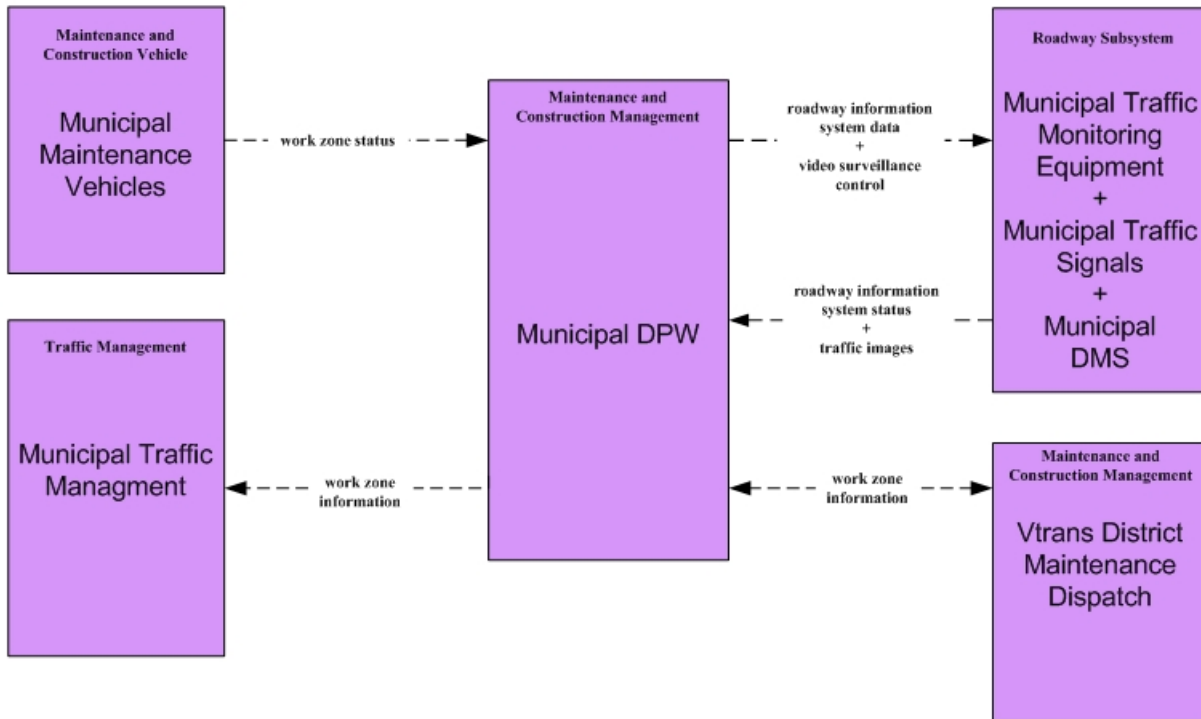

MC08 - Work Zone Management
Shelburne DPW

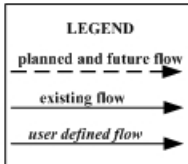
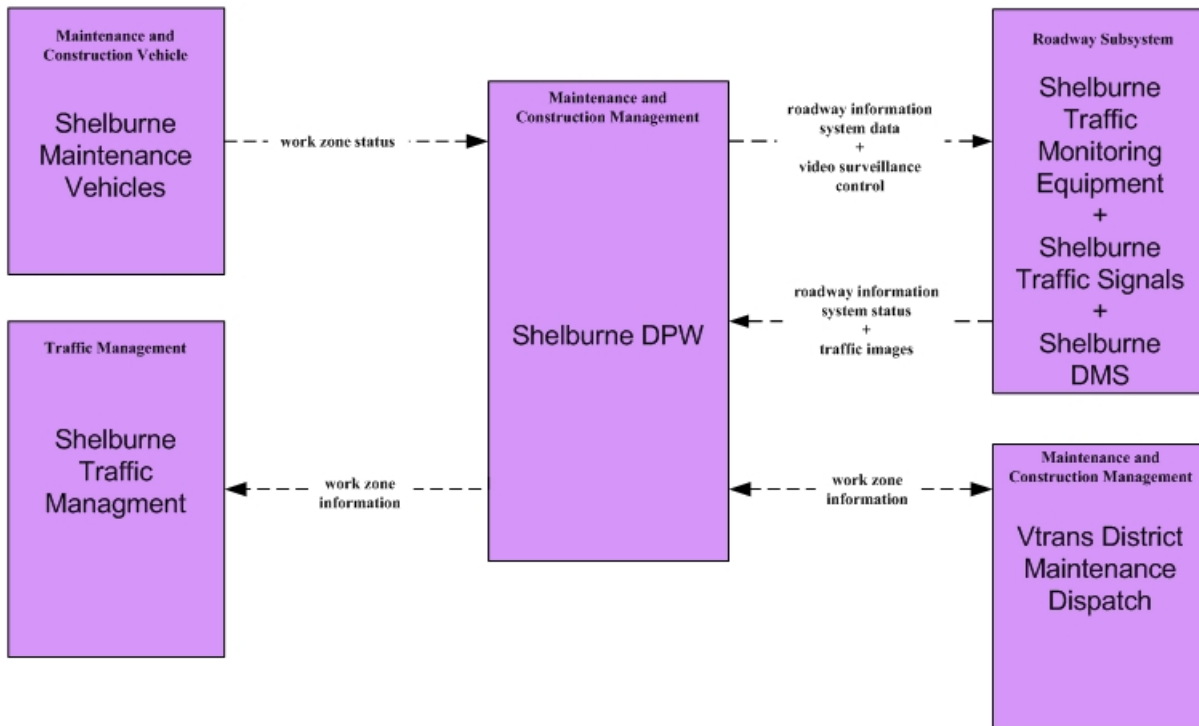

MC08 - Work Zone Management South Burlington DPW

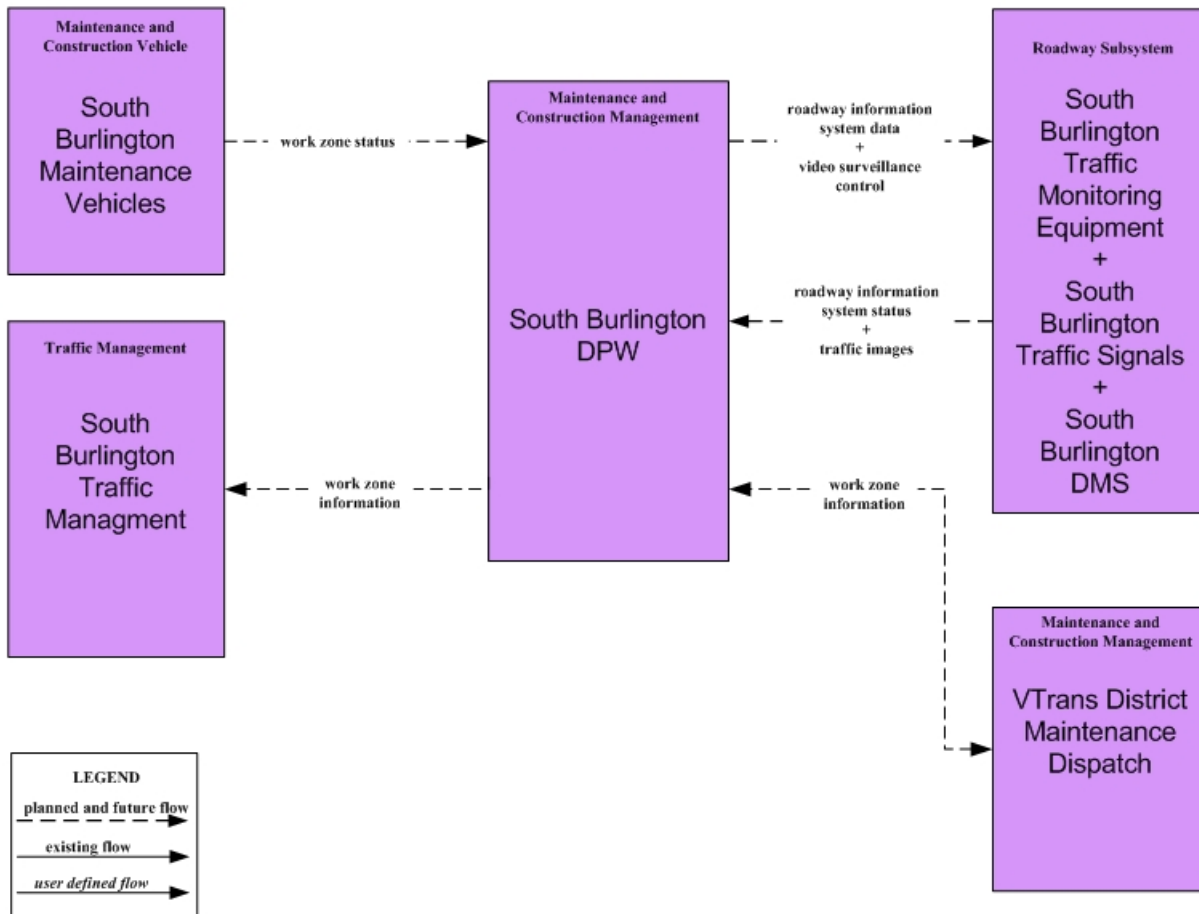

MC08 - Work Zone Management
VTrans District Maintenance Dispatch

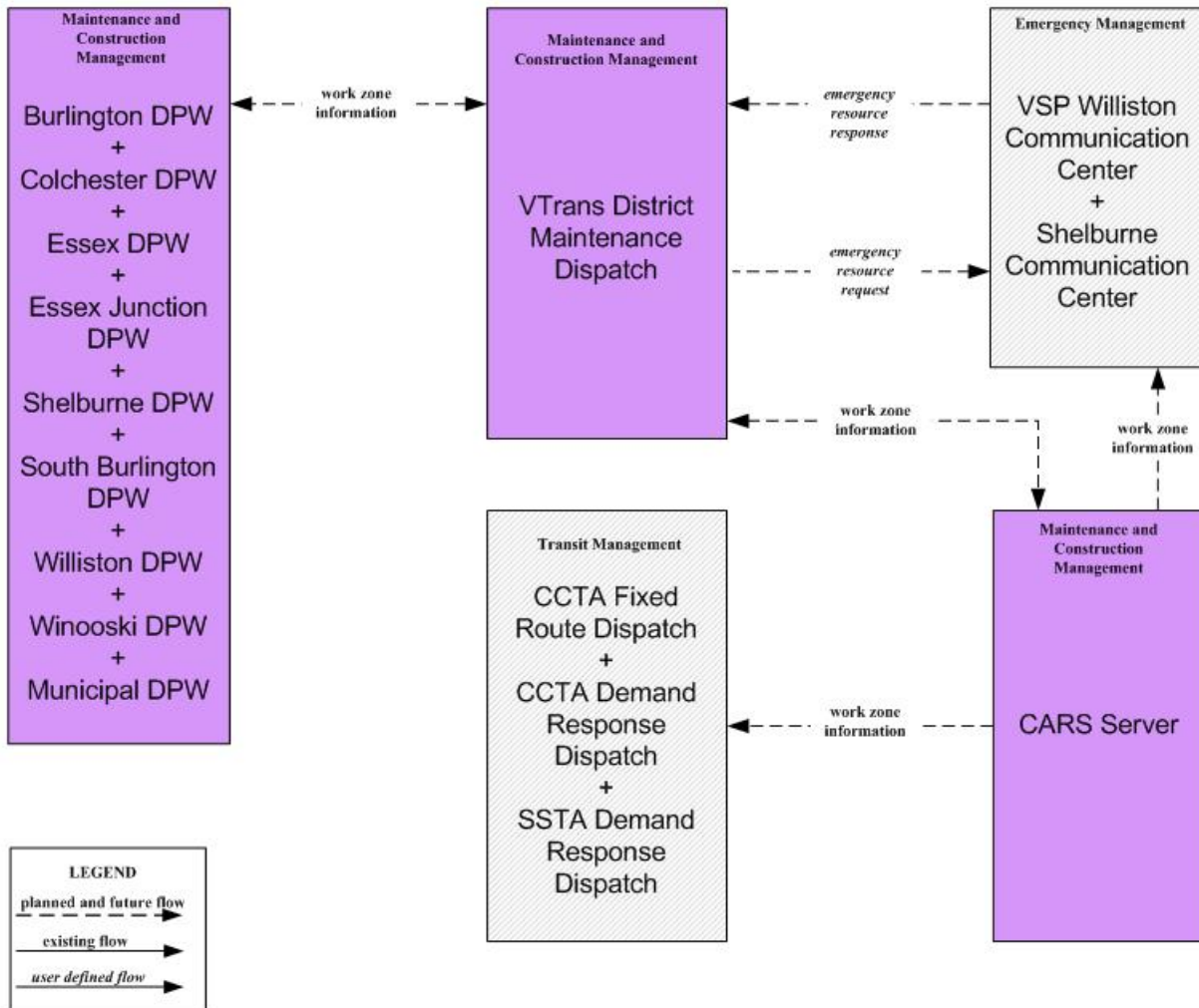

MC08 - Work Zone Management
Williston DPW

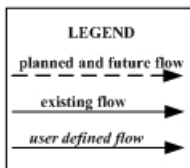
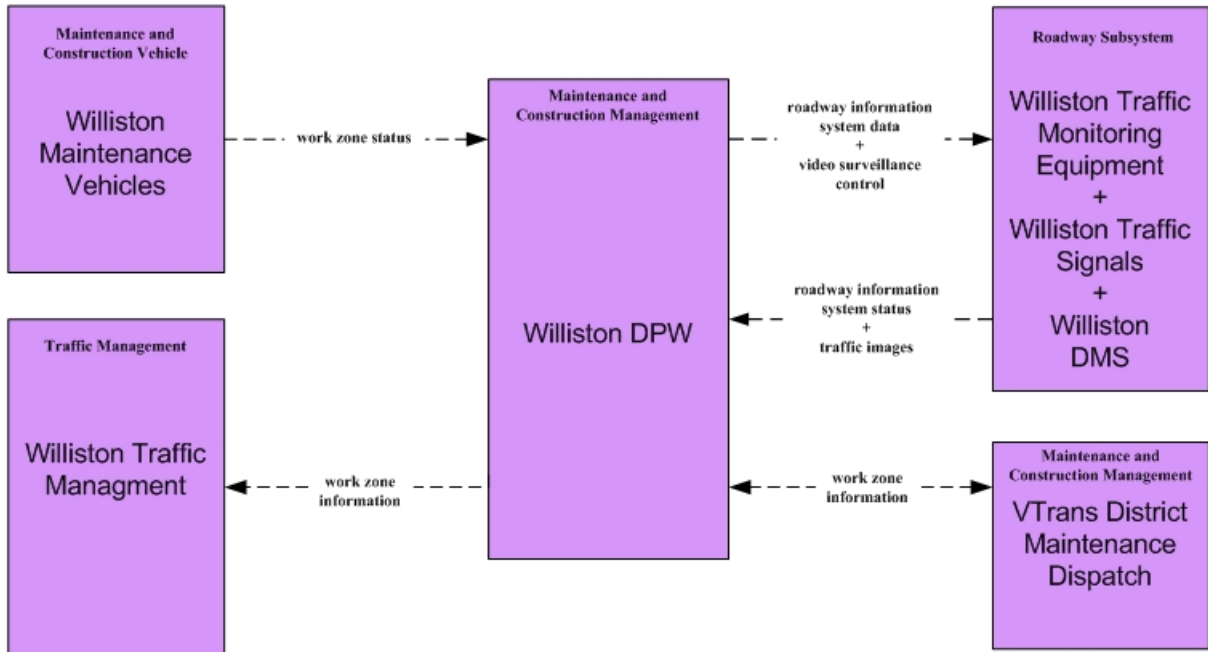

MC08 - Work Zone Management
Winooski DPW

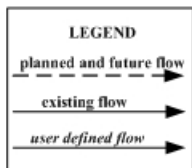
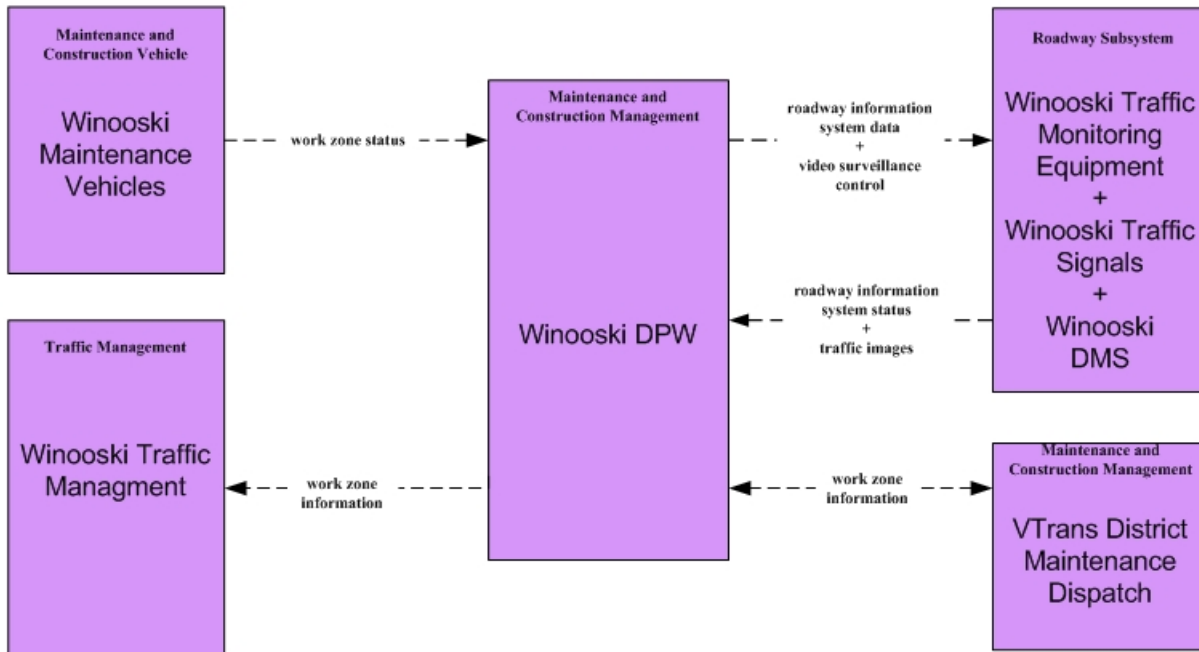

MC10 – Maintenance and Construction Activity Coordination
Burlington DPW

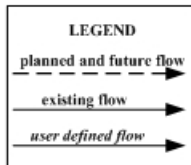
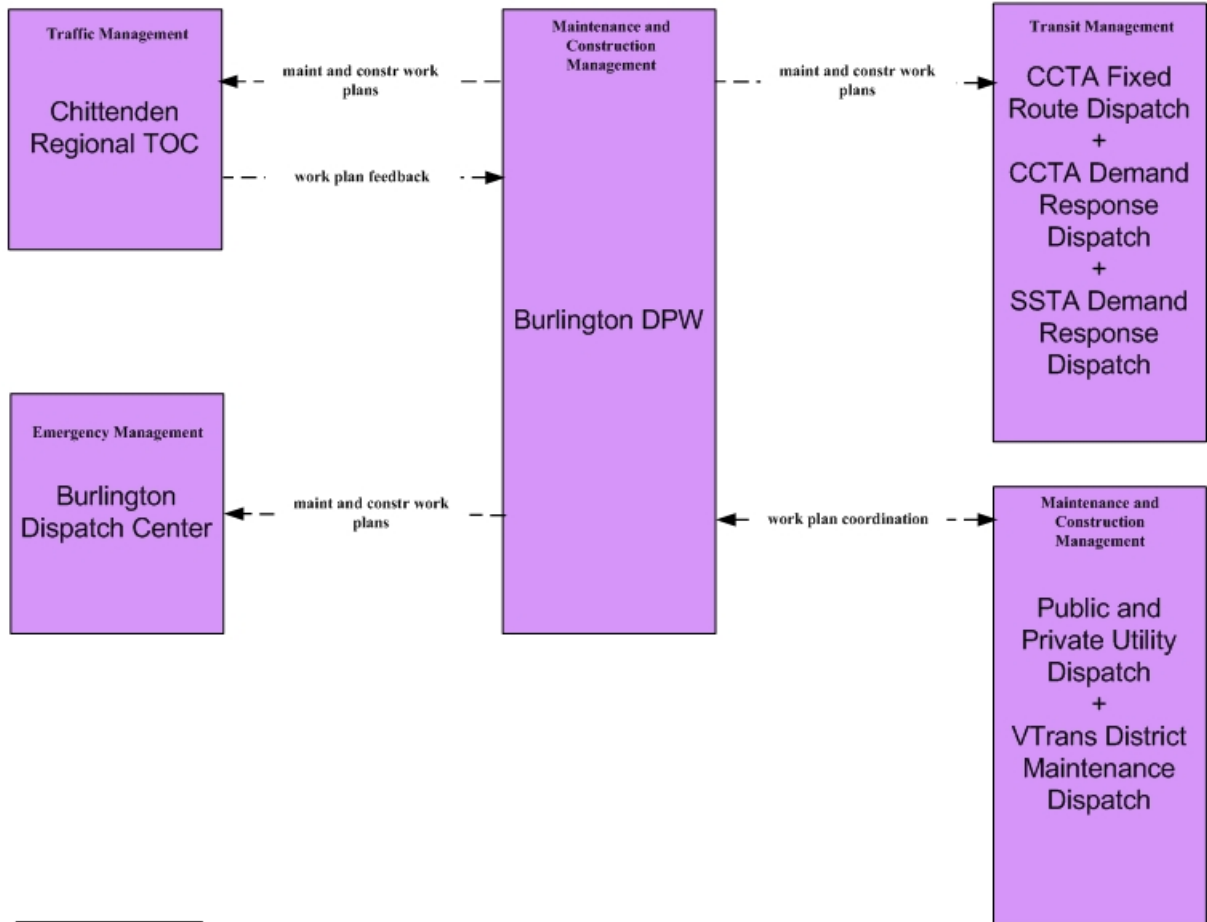

MC10 – Maintenance and Construction Activity Coordination
CARS Server

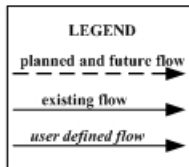
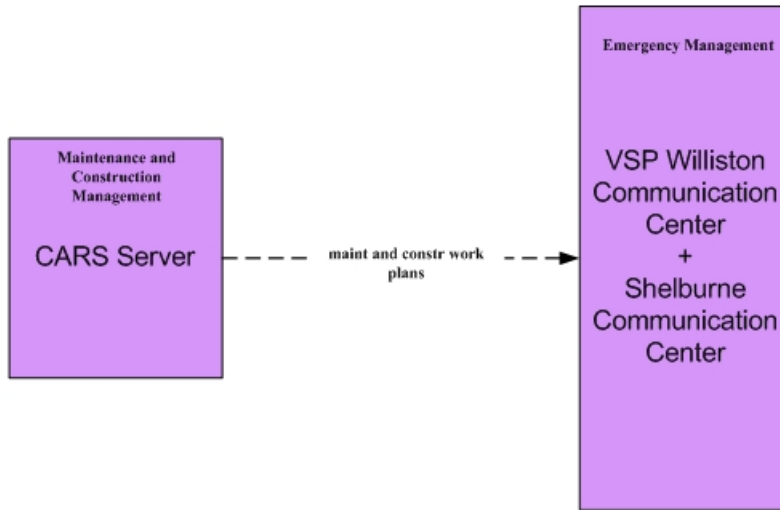

MC10 – Maintenance and Construction Activity Coordination
CARS Information System

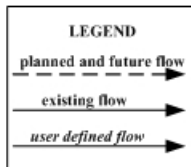
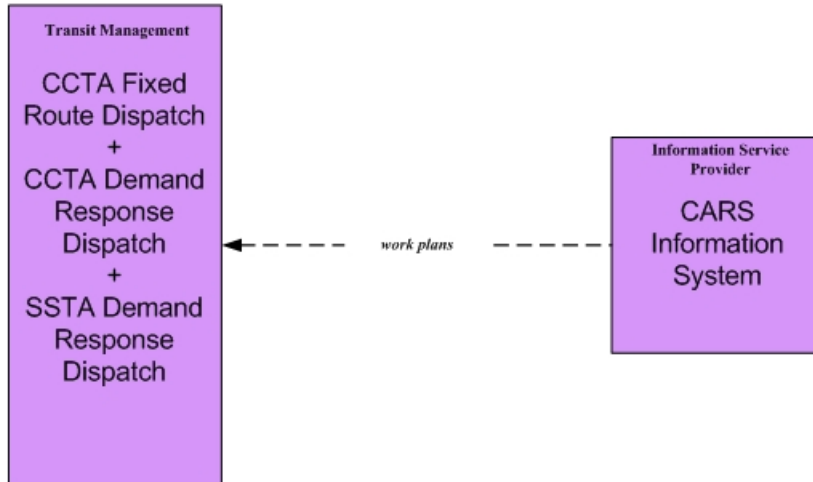

MC10 – Maintenance and Construction Activity Coordination
Colchester DPW

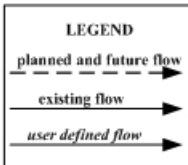
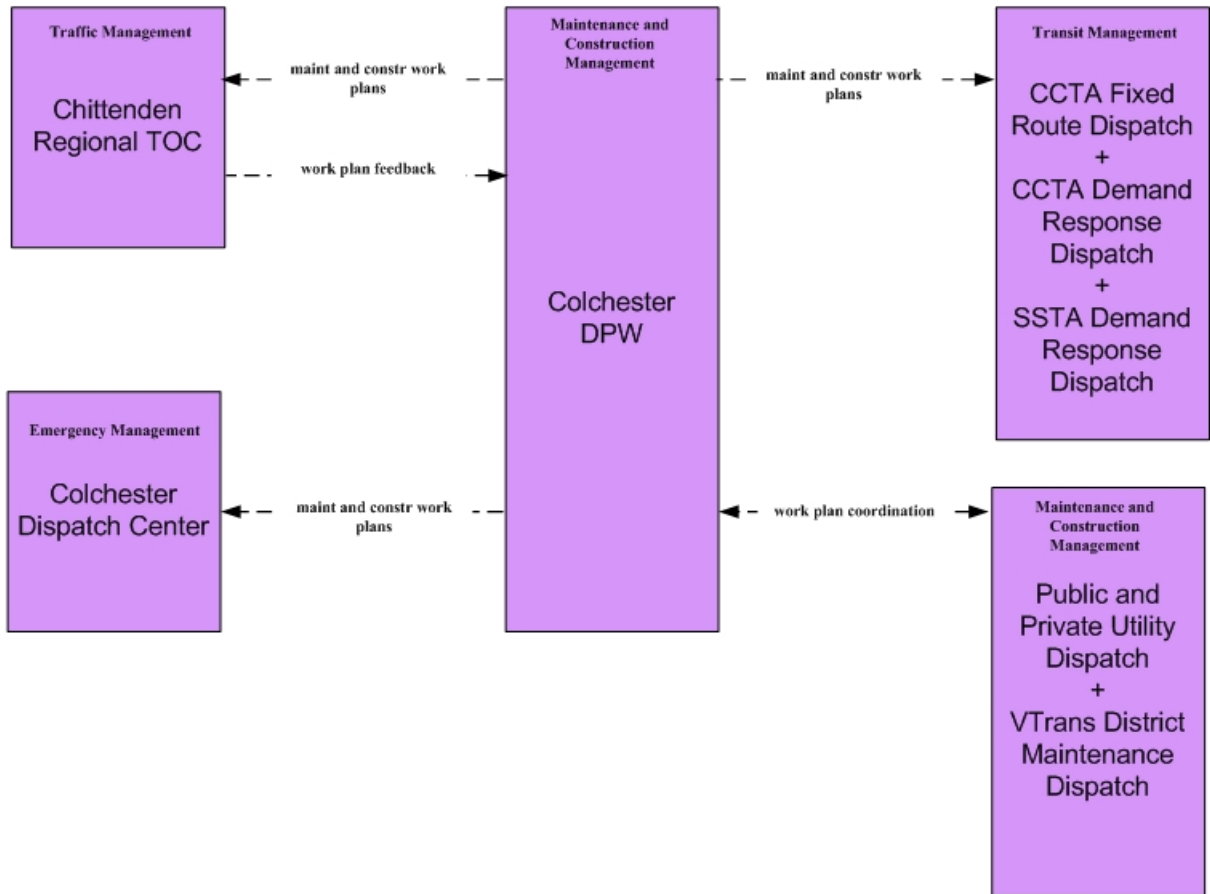

MC10 – Maintenance and Construction Activity Coordination
Essex DPW

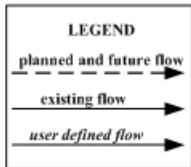
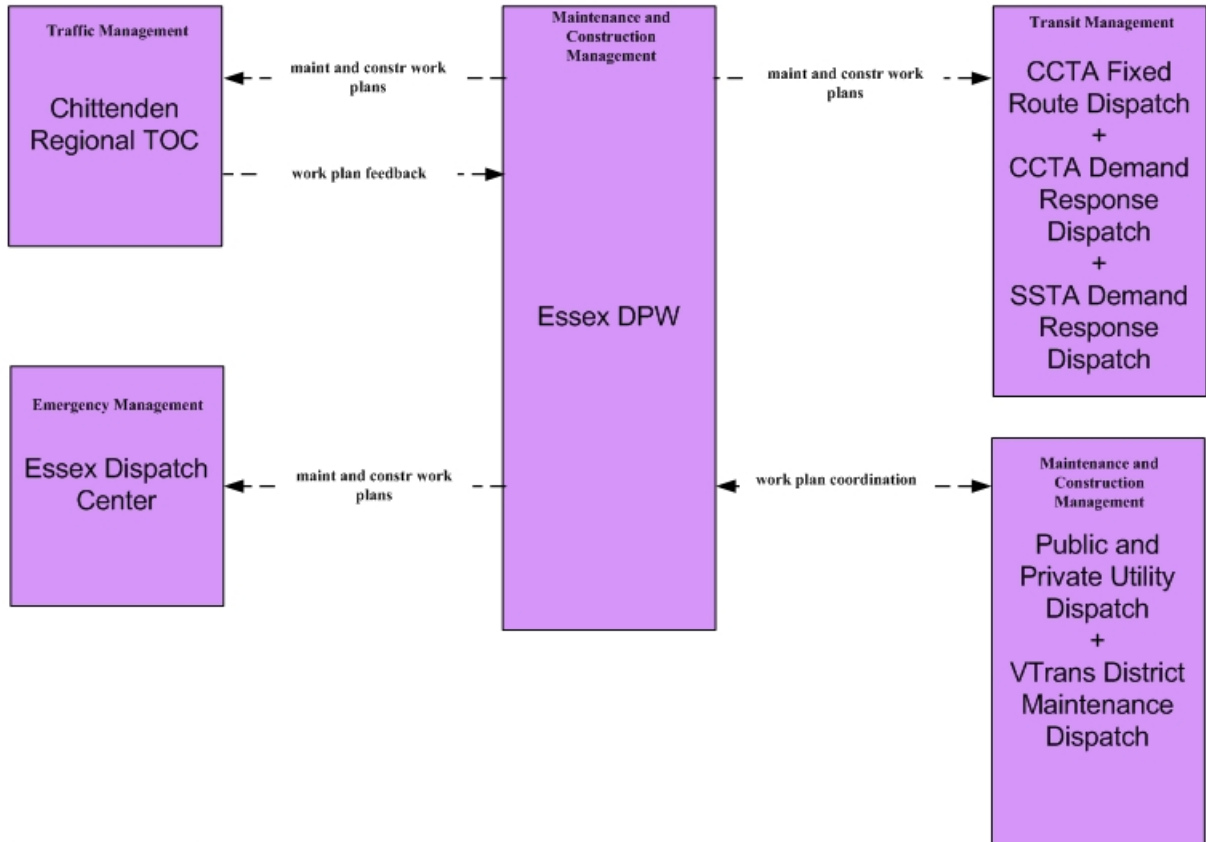

MC10 – Maintenance and Construction Activity Coordination
Essex Junction DPW

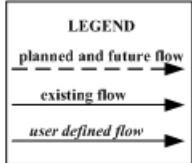
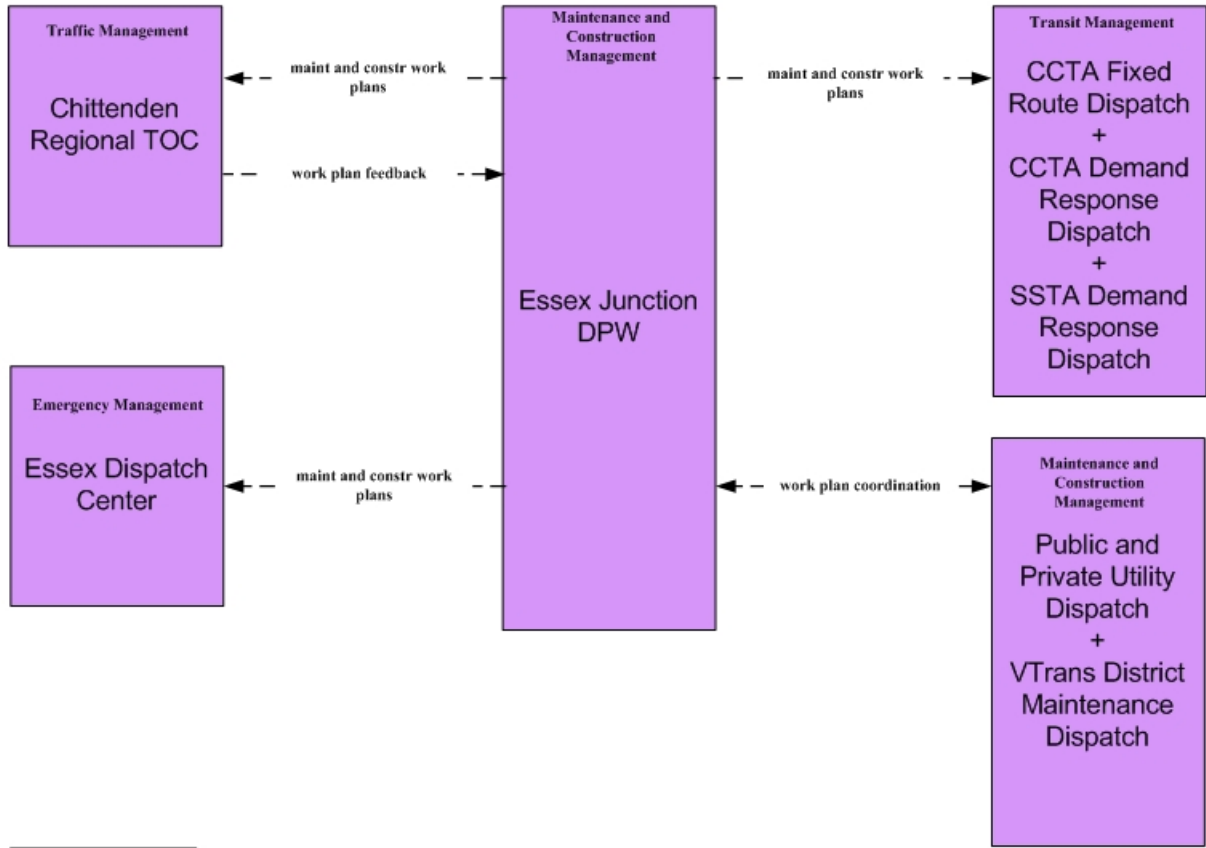

MC10 – Maintenance and Construction Activity Coordination
Municipal DPW

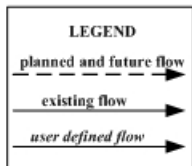
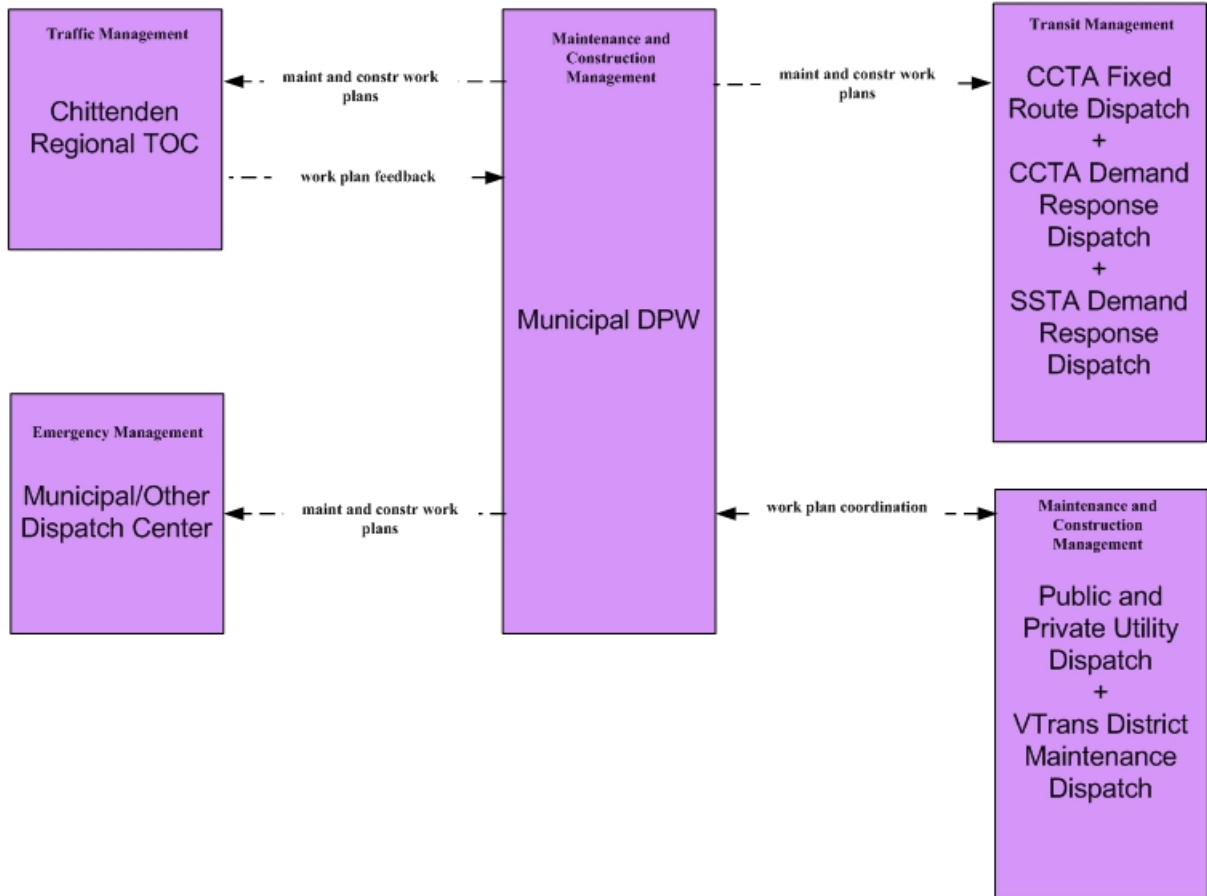

MC10 – Maintenance and Construction Activity Coordination
Shelburne DPW

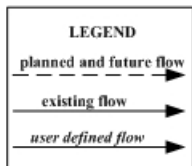
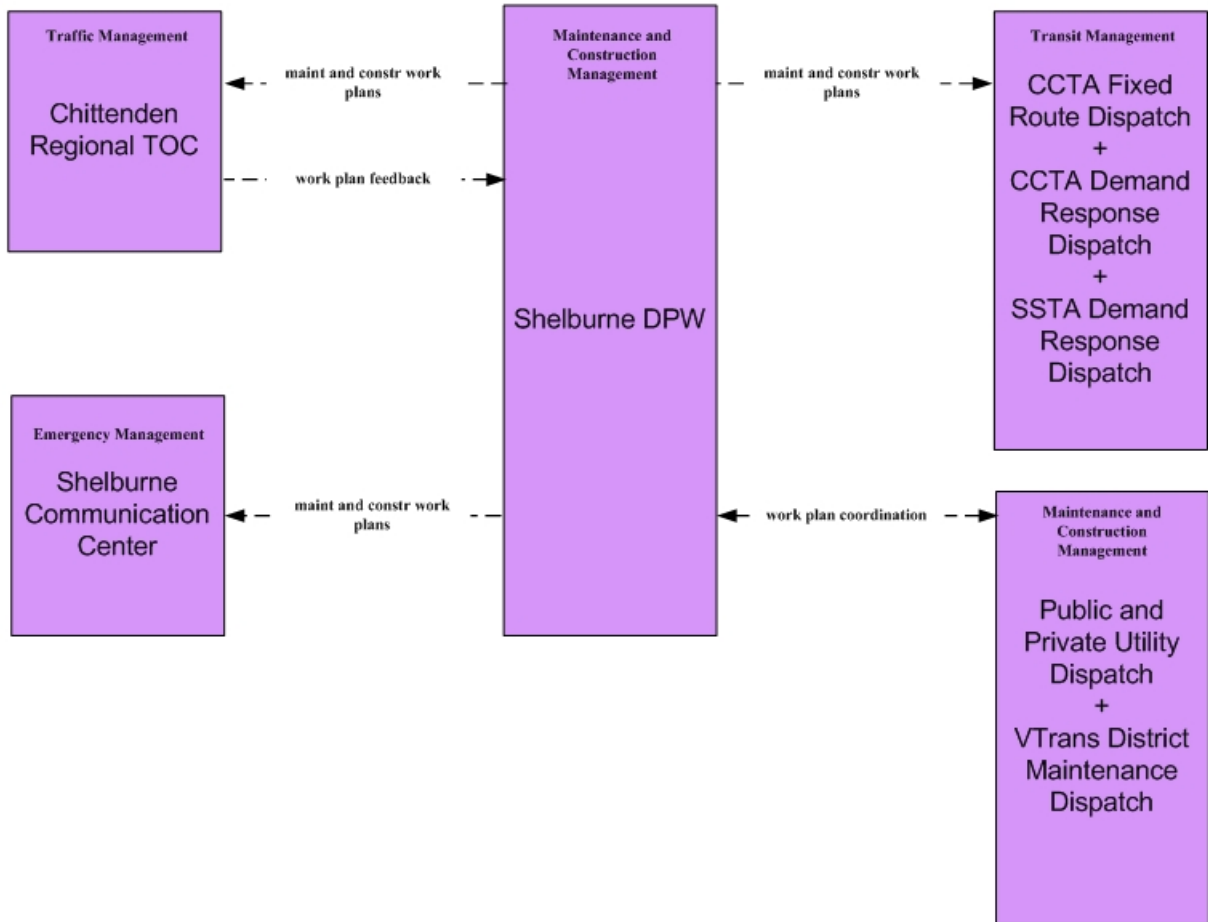

MC10 – Maintenance and Construction Activity Coordination
South Burlington DPW

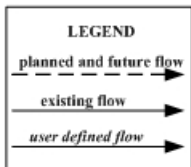
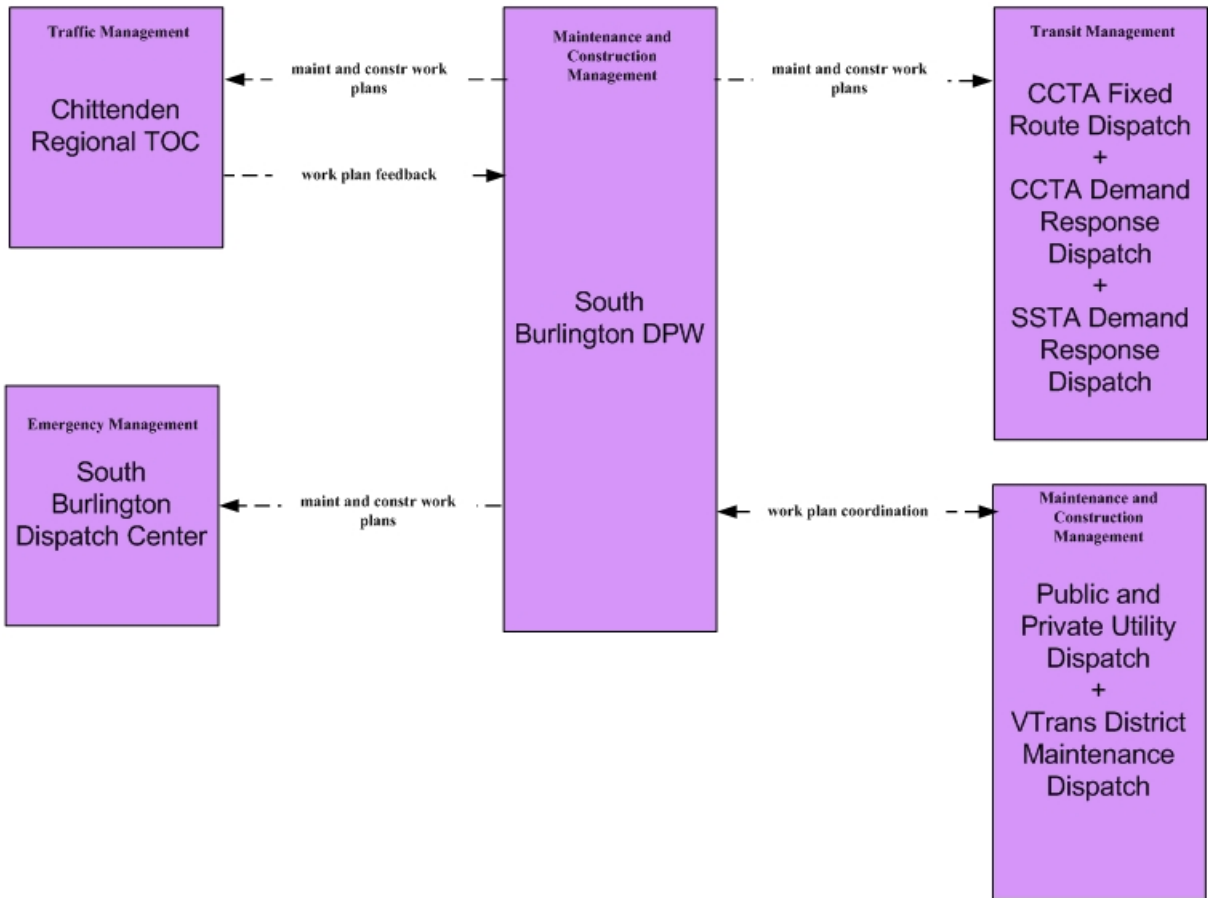

MC10 – Maintenance and Construction Activity Coordination
VTrans

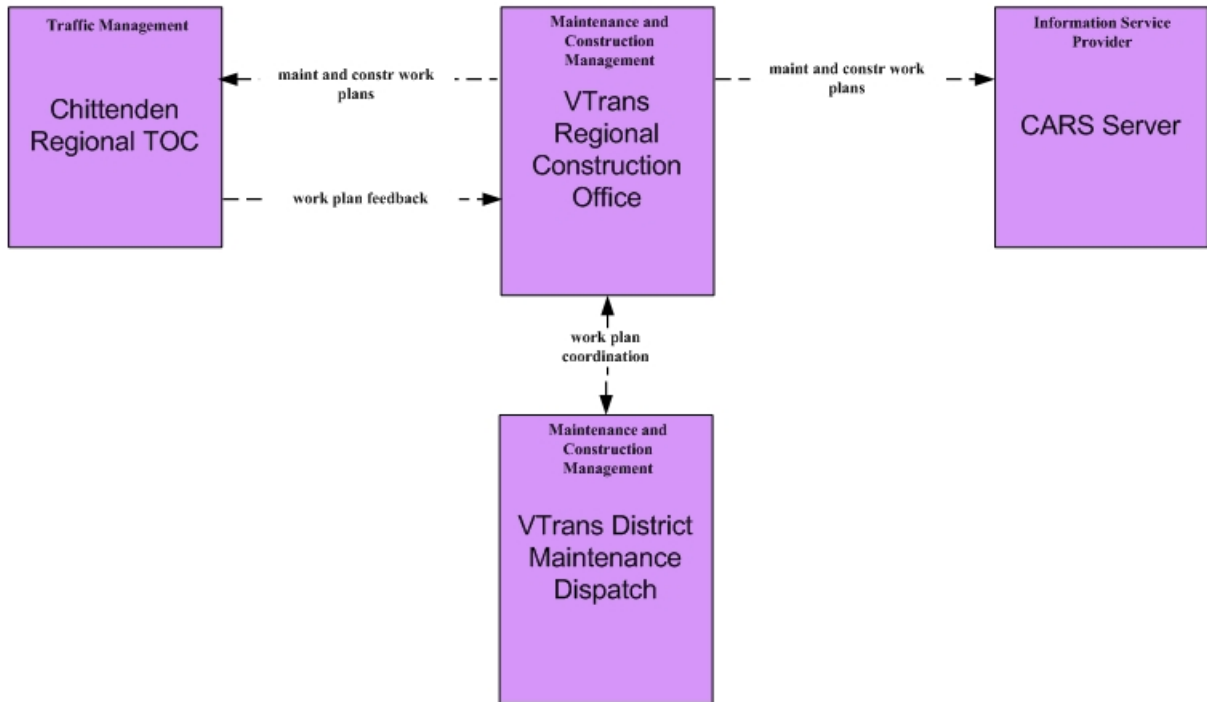

LEGEND

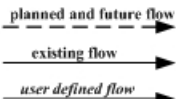

MC10 – Maintenance and Construction Activity Coordination
Williston DPW

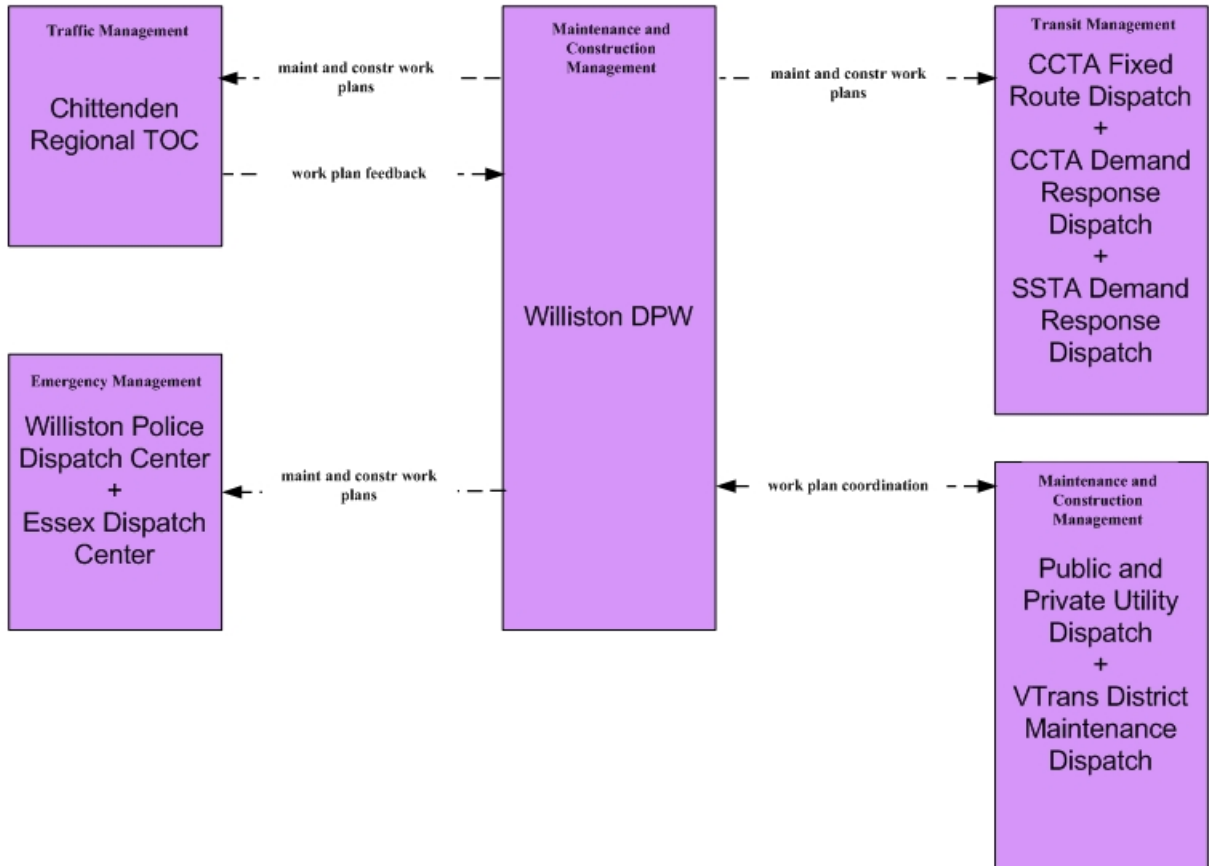

LEGEND

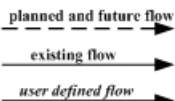

MC10 – Maintenance and Construction Activity Coordination
Winooski DPW

