

AD1 - ITS Data Mart Statewide Crash Records

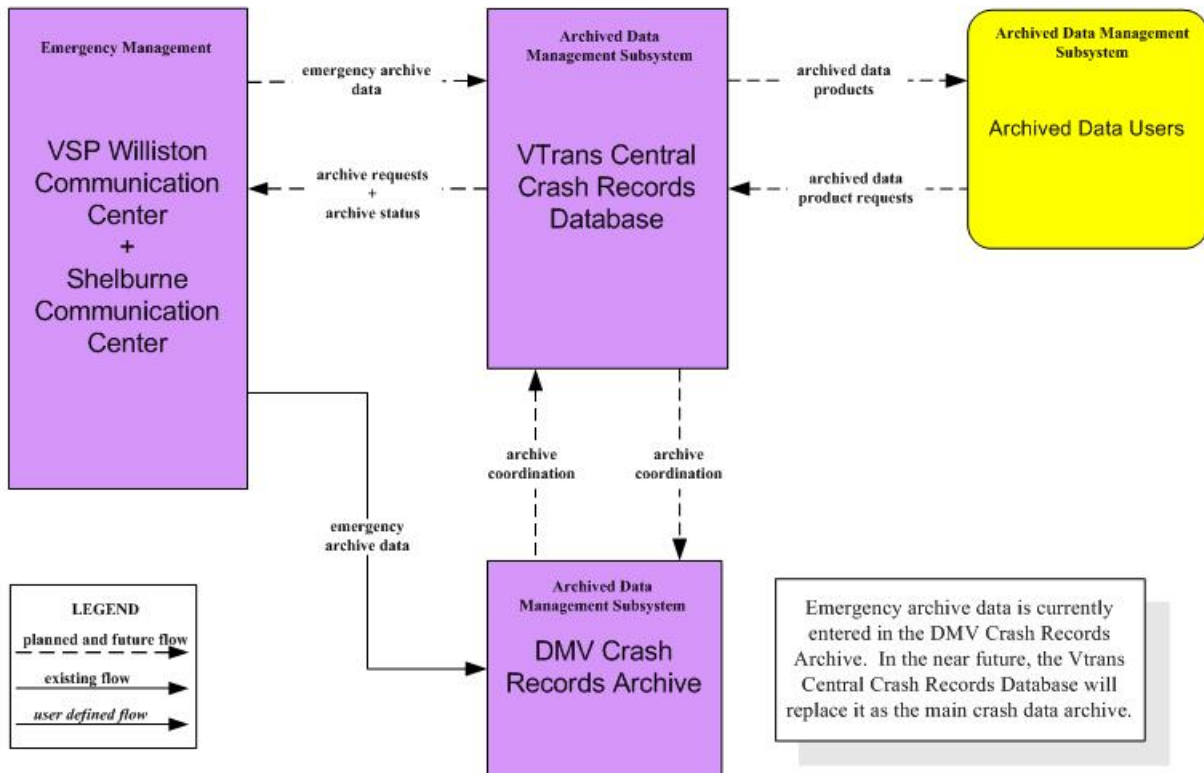

AD2 - ITS Data Warehouse
CODES Database

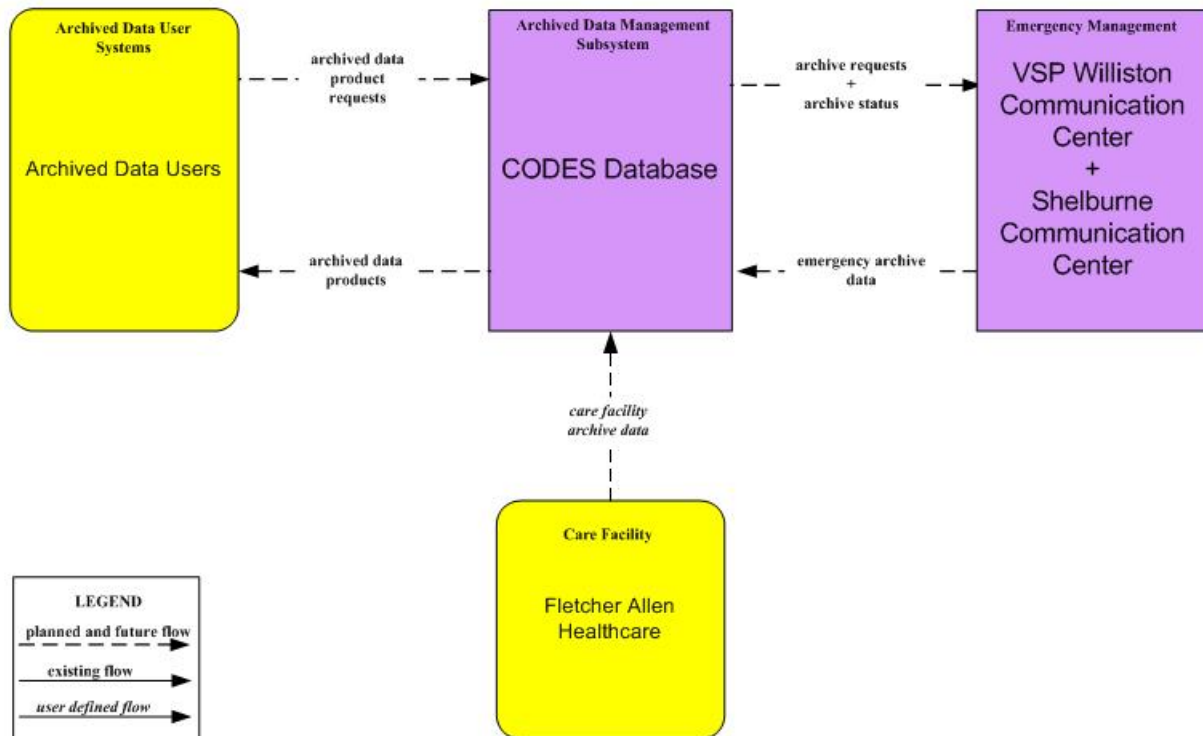

AD2 - ITS Data Warehouse
VTrans Data Warehouse

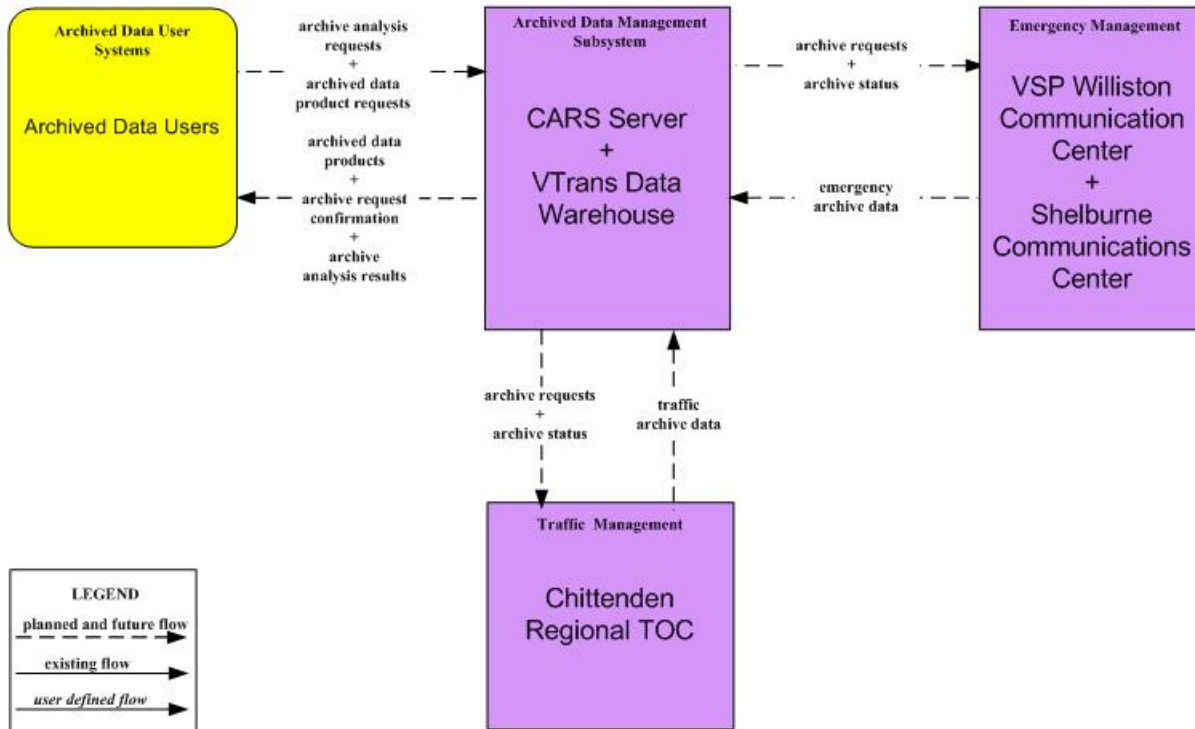

APTS5 - Transit Security

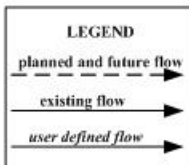
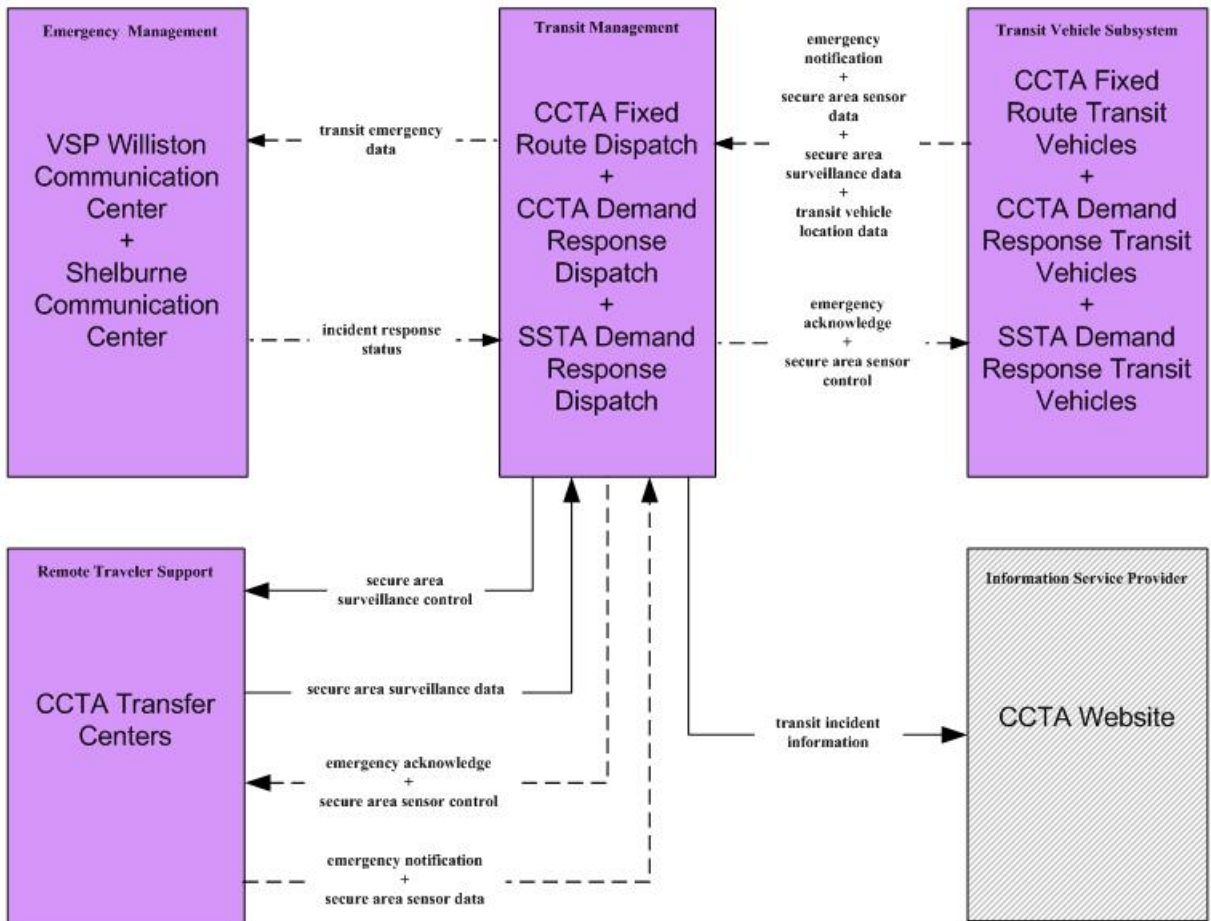

ATIS1 - Broadcast Traveler Information CARS Information System

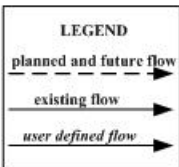
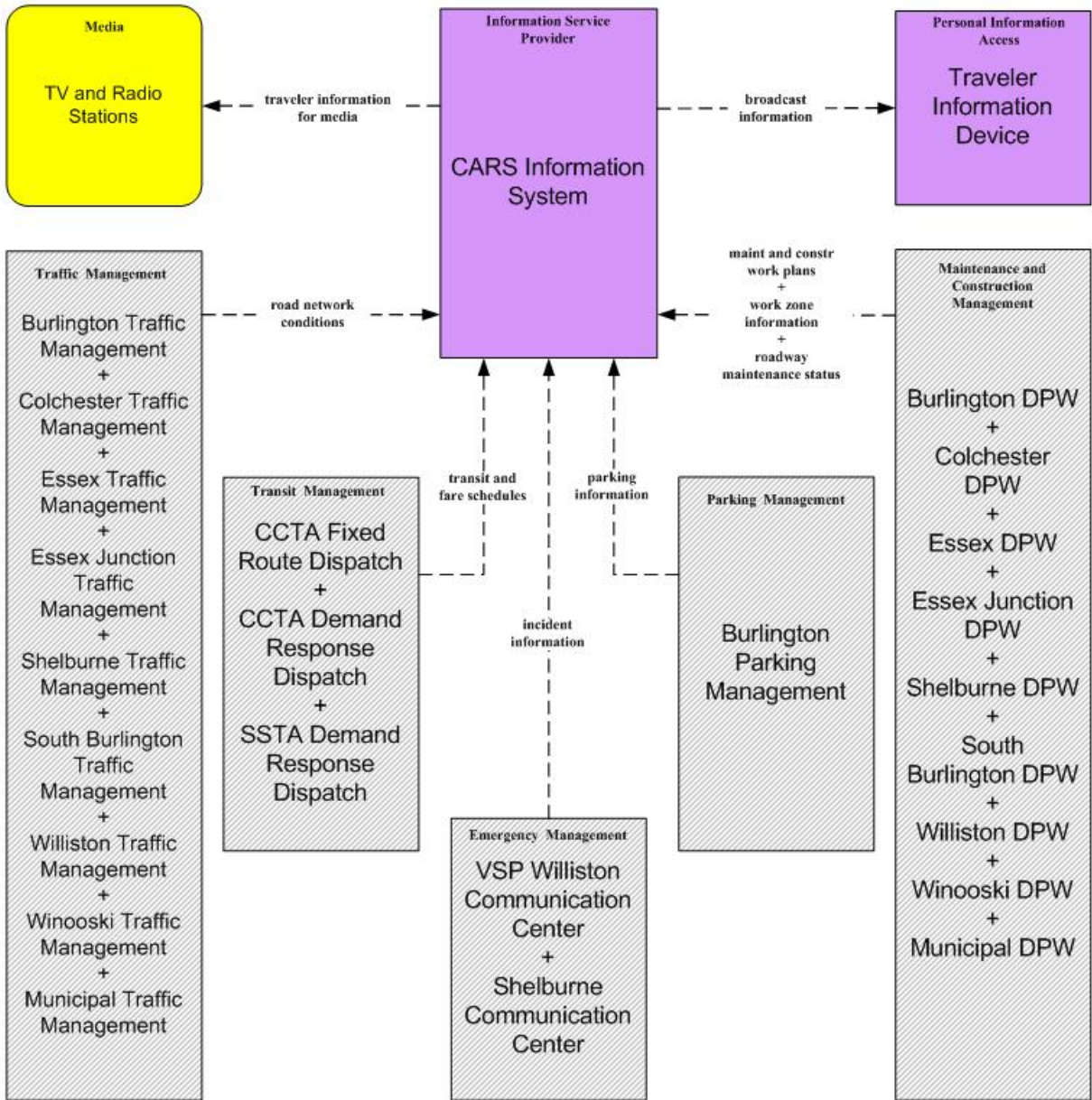

This market package instance is valid if the Chittenden Regional TOC is not created. See the ATIS1 – CARS – Chittenden Regional TOC instance for details if it is.

ATIS1 - Broadcast Traveler Information
 CARS Information System – Chittenden Regional TOC

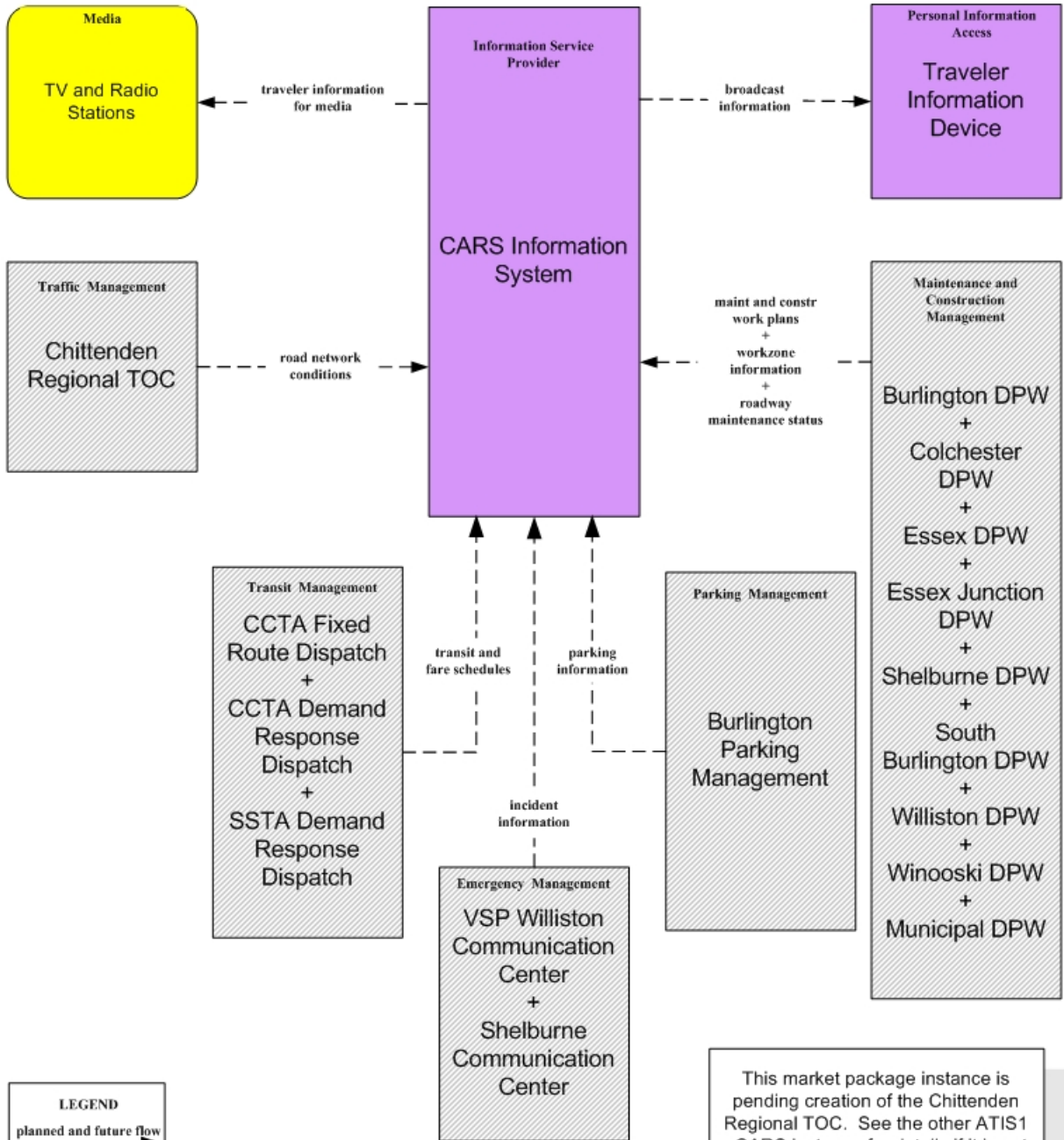

This market package instance is pending creation of the Chittenden Regional TOC. See the other ATIS1 - CARS instance for details if it is not.

ATMS06 – Traffic Information Dissemination
Burlington Traffic Management

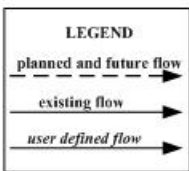
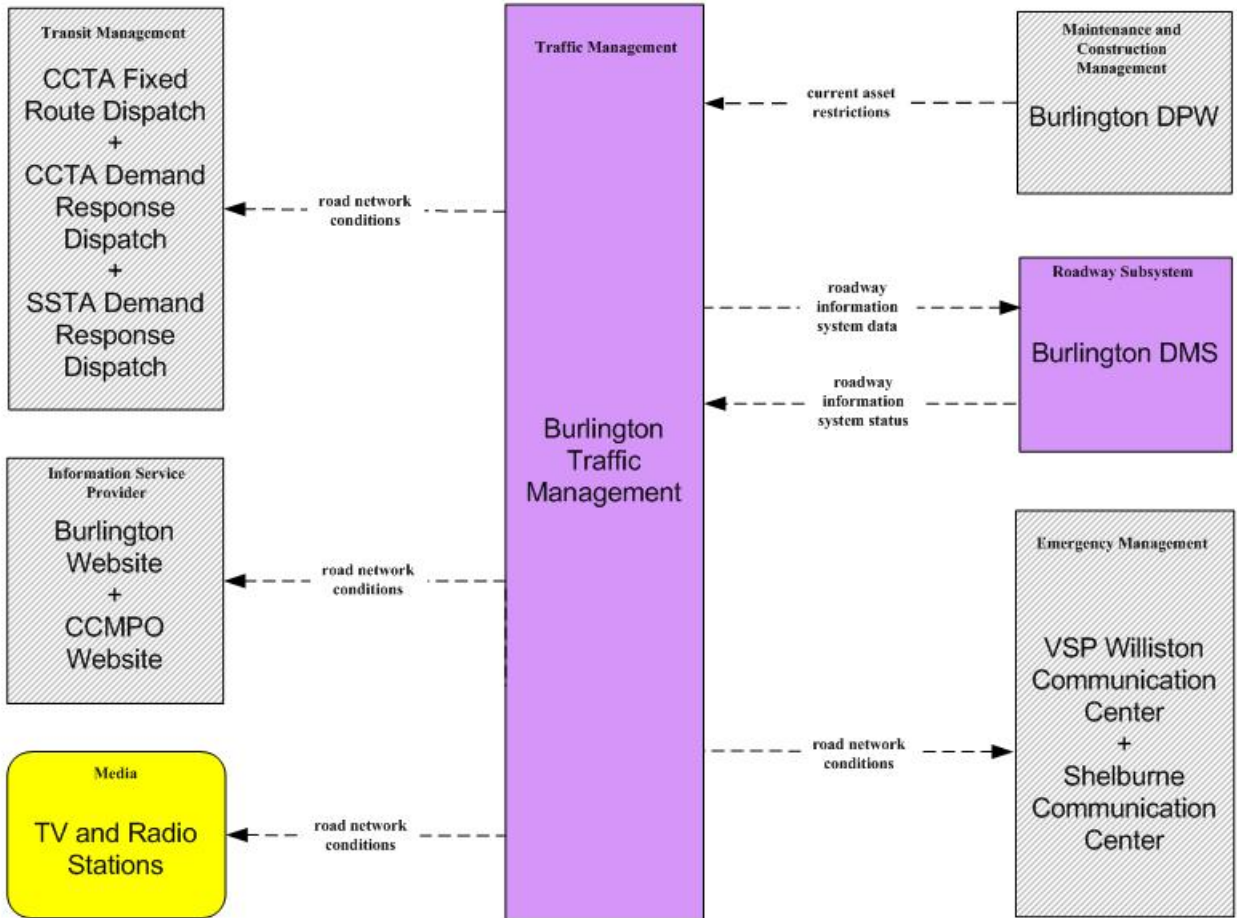

ATMS06 – Traffic Information Dissemination Colchester Traffic Management

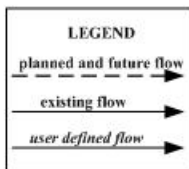
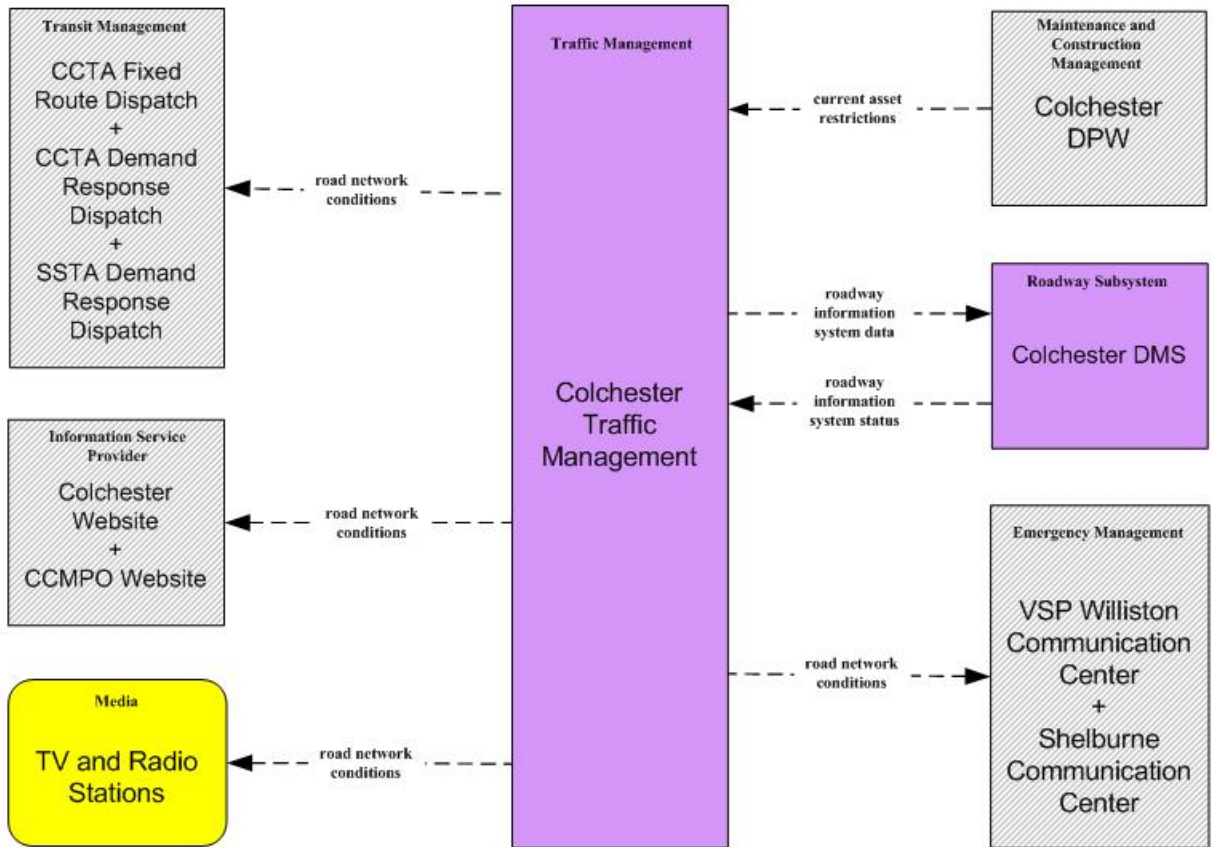

**ATMS06 – Traffic Information Dissemination
Chittenden Regional TOC (Future)**

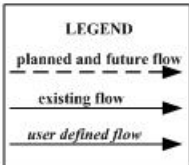
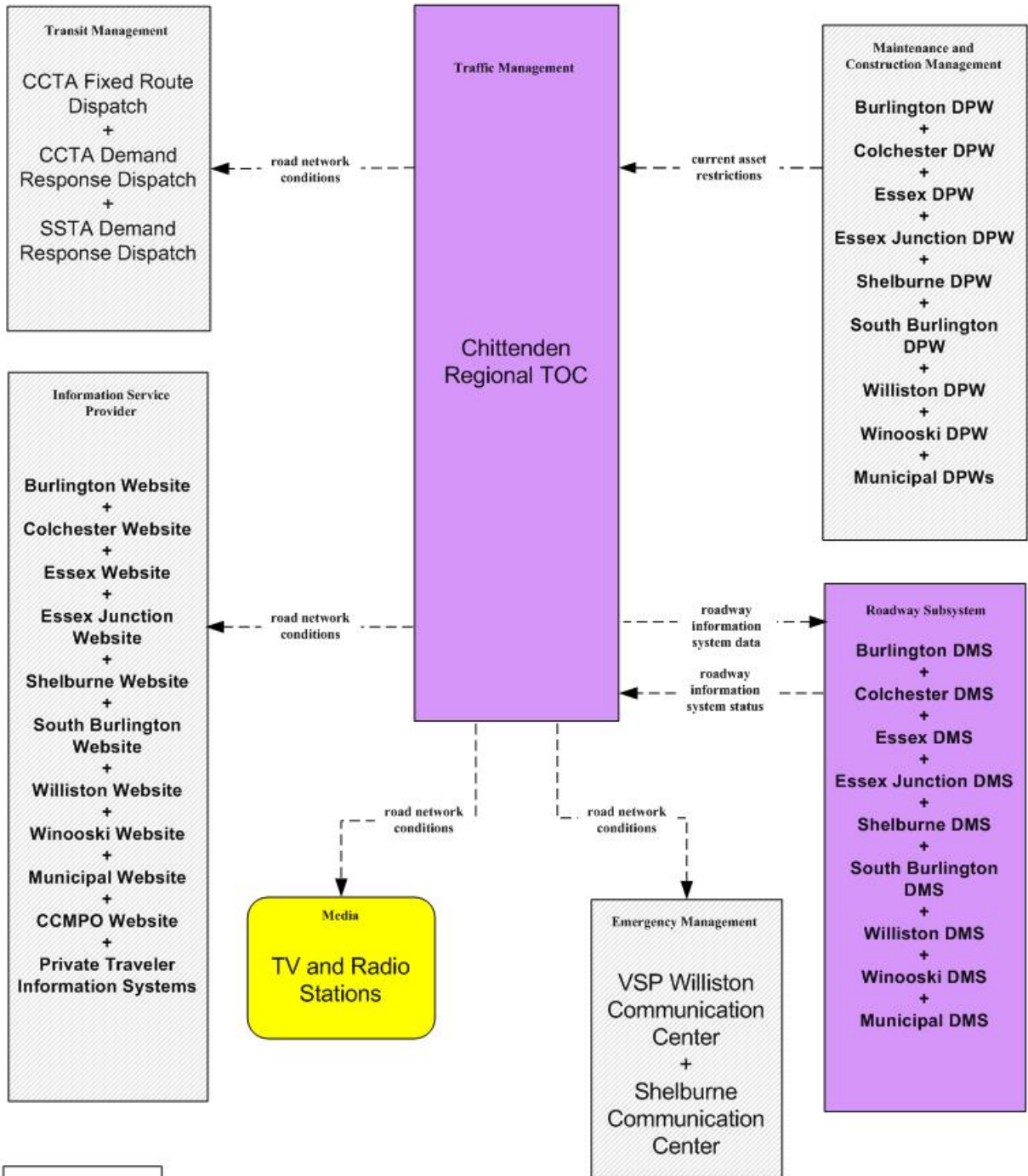

ATMS06 – Traffic Information Dissemination
Essex Traffic Management

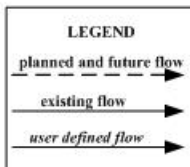
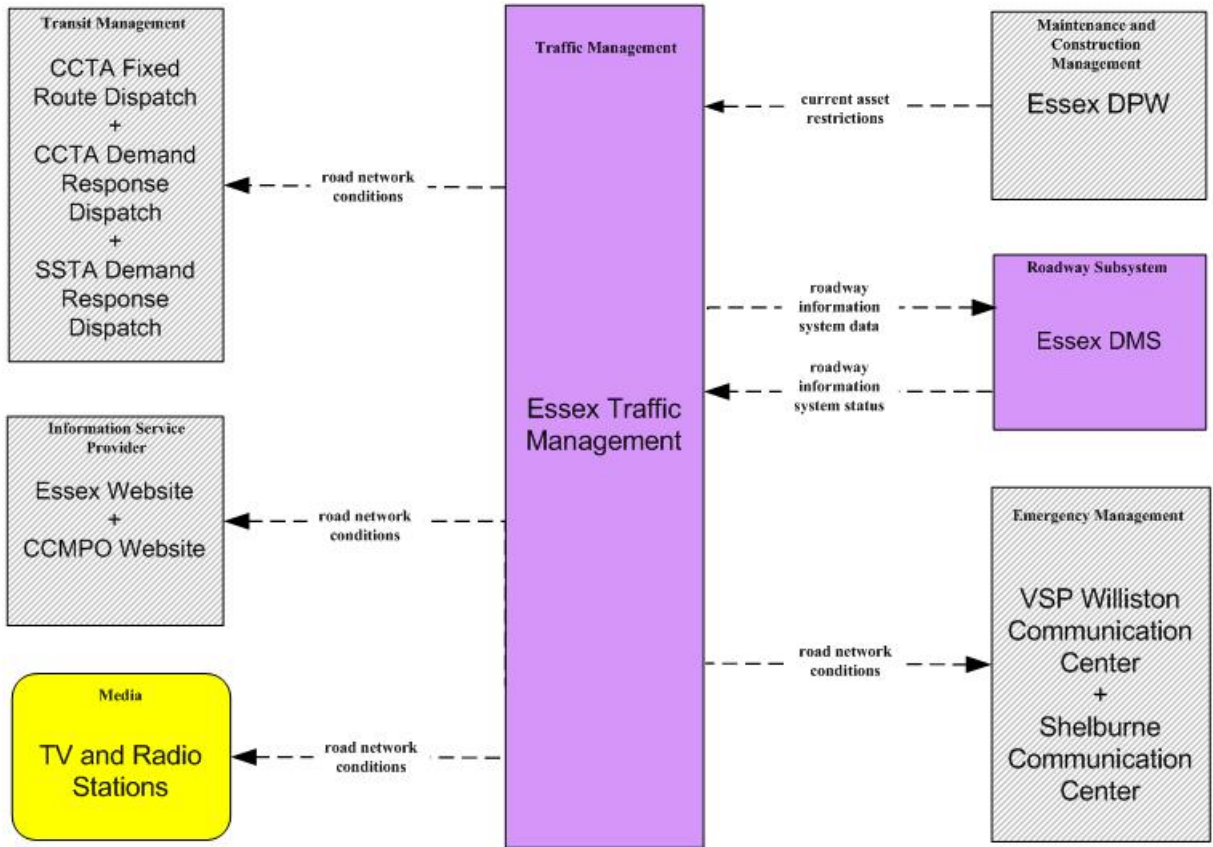

ATMS06 – Traffic Information Dissemination
Essex Junction Traffic Management

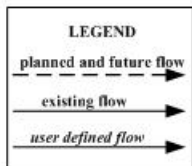
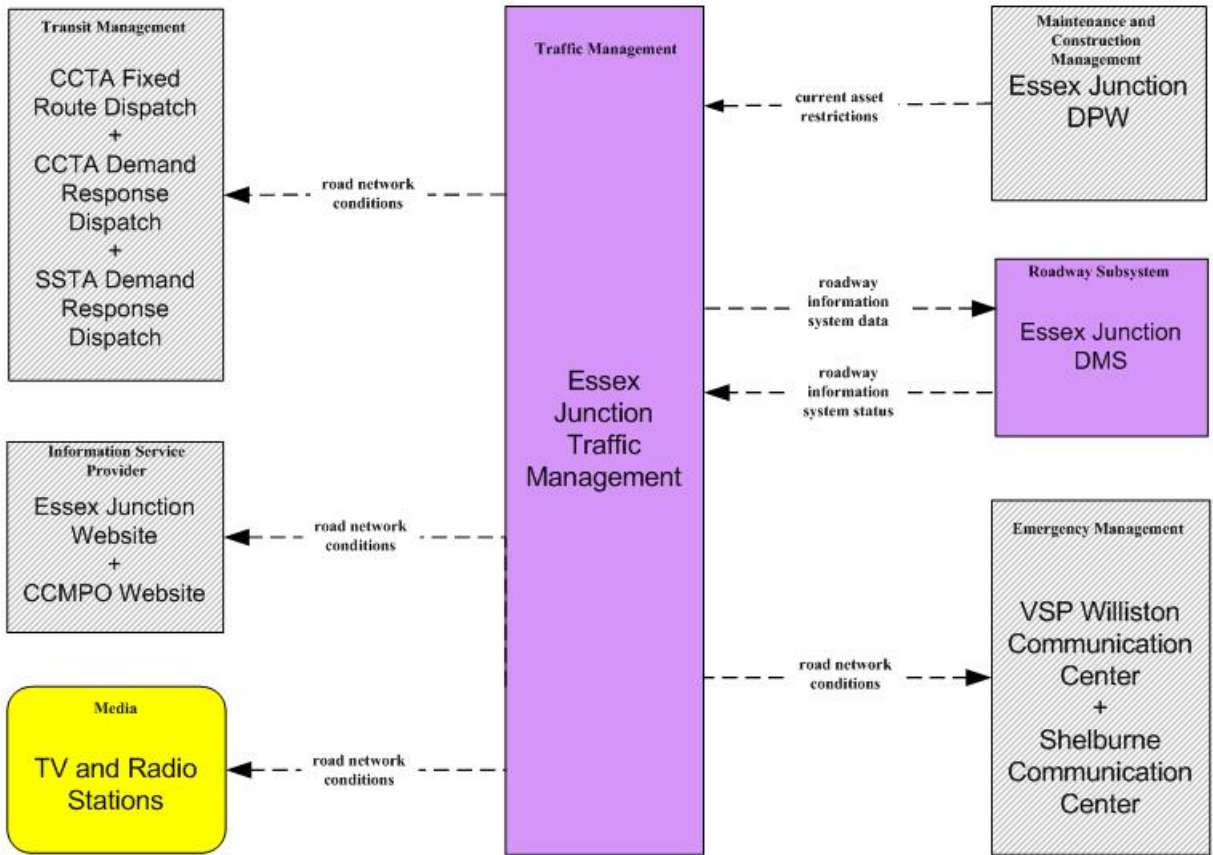

ATMS06 – Traffic Information Dissemination
Municipal Traffic Management

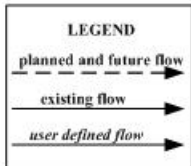
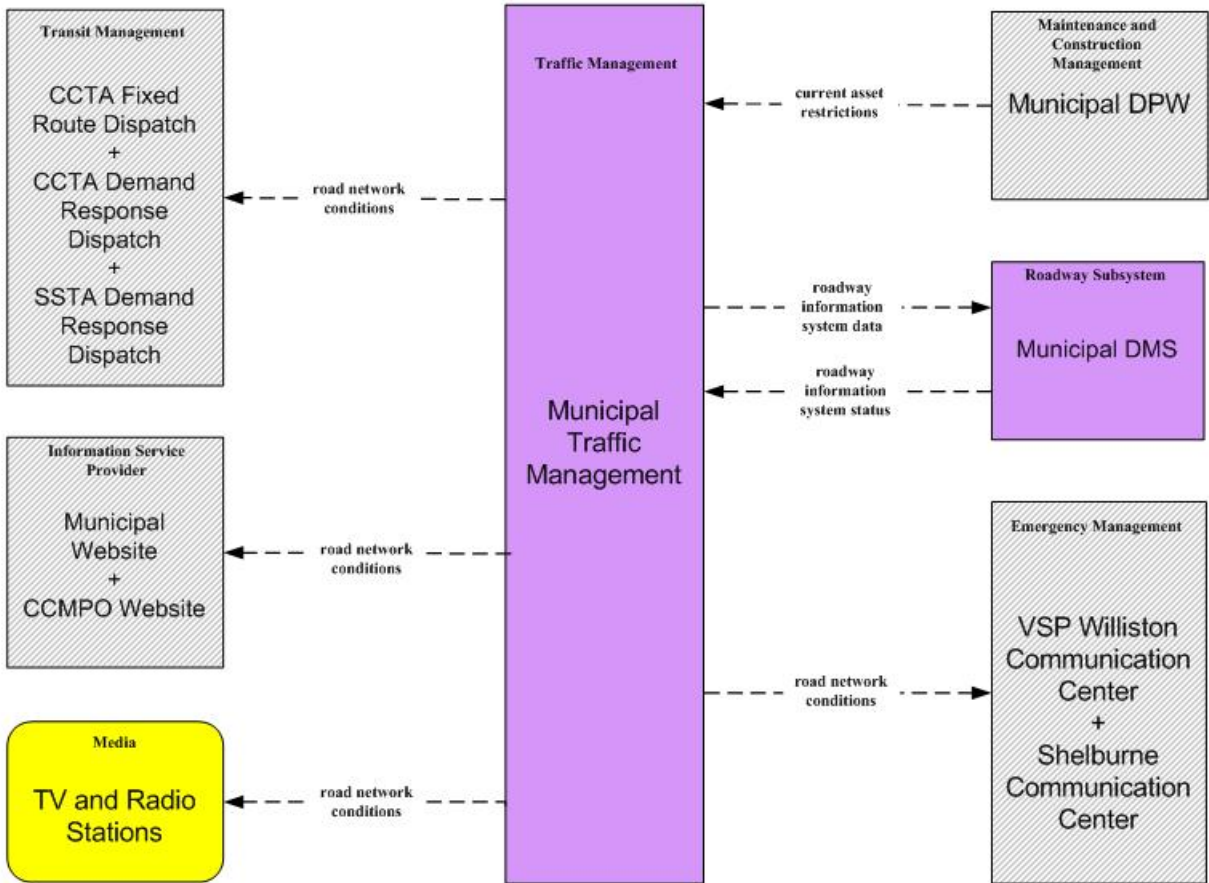

ATMS06 – Traffic Information Dissemination
Shelburne Traffic Management

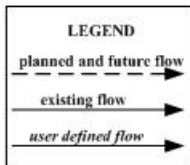
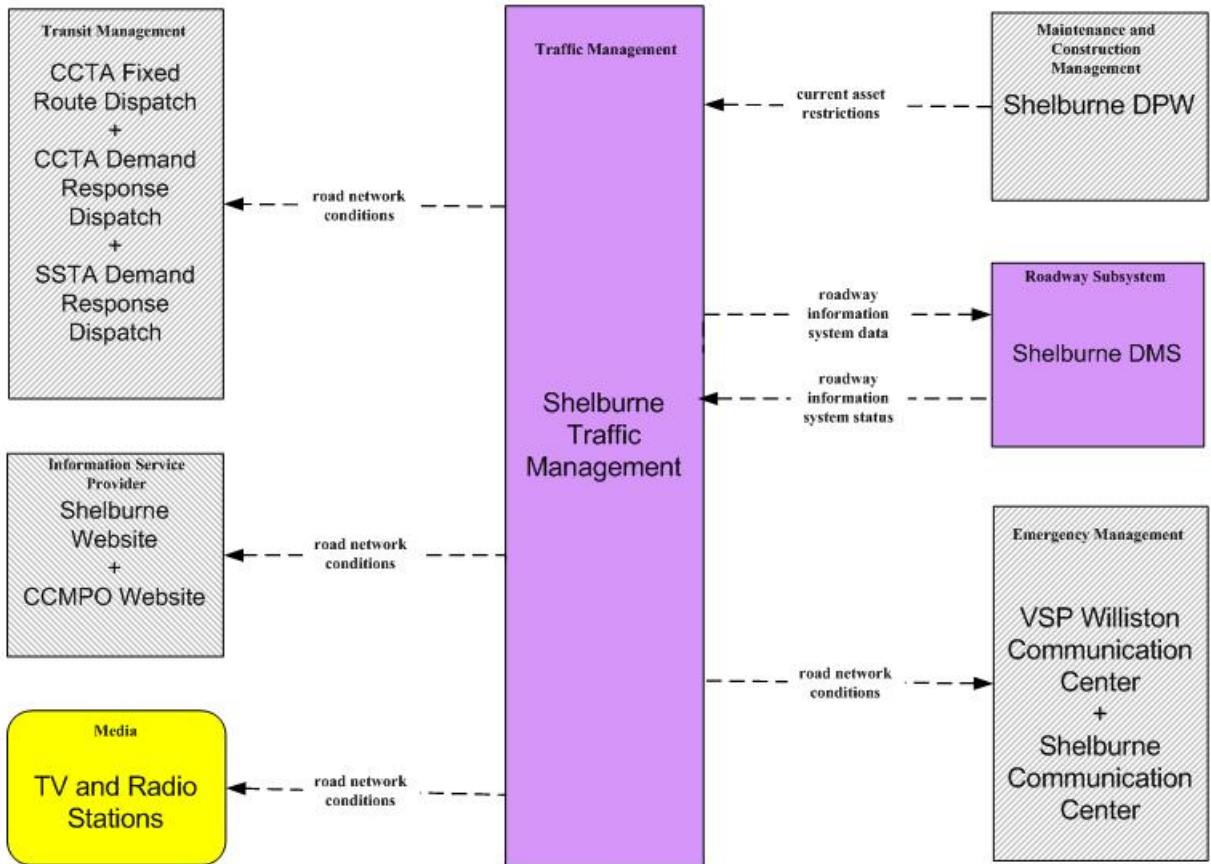

ATMS06 – Traffic Information Dissemination South Burlington Traffic Management

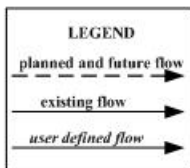
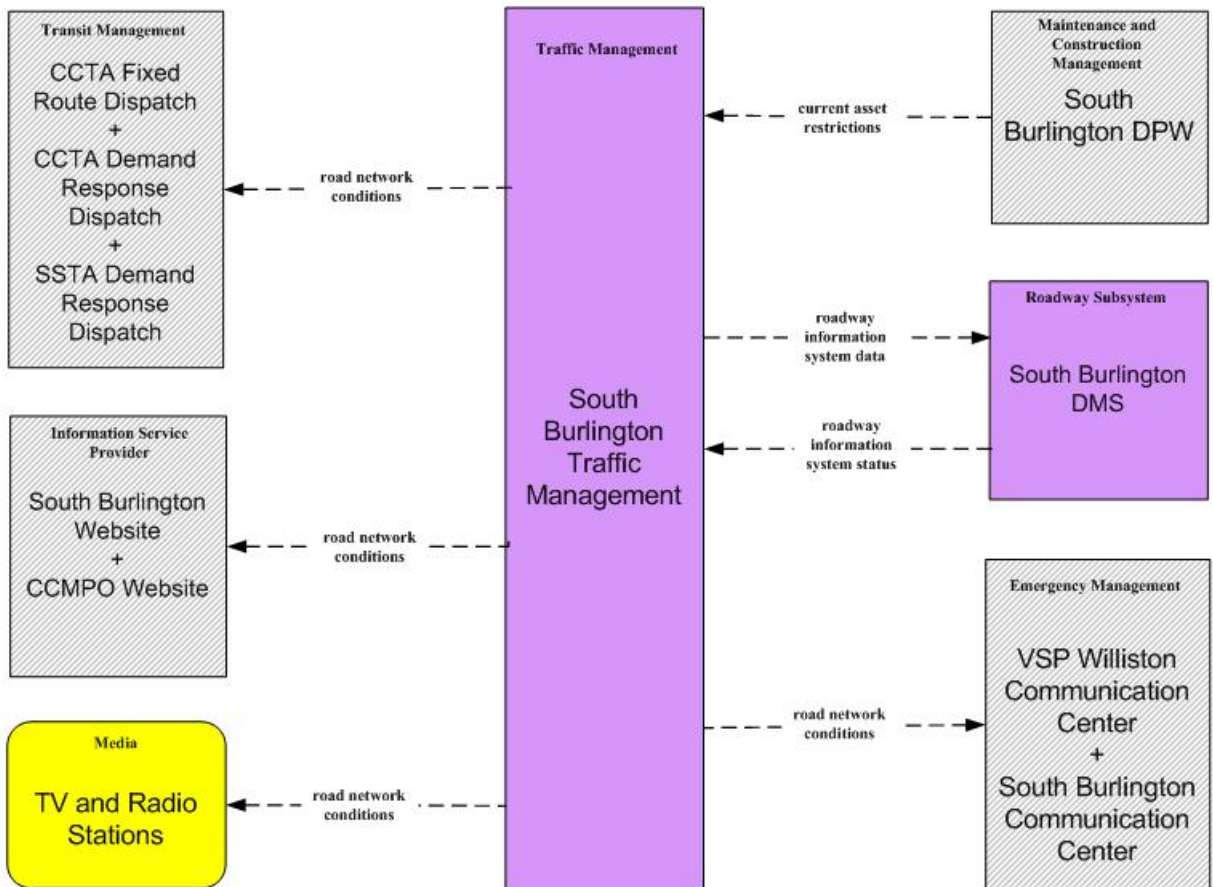

ATMS06 – Traffic Information Dissemination
Williston Traffic Management

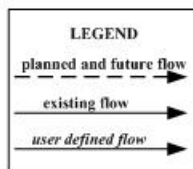
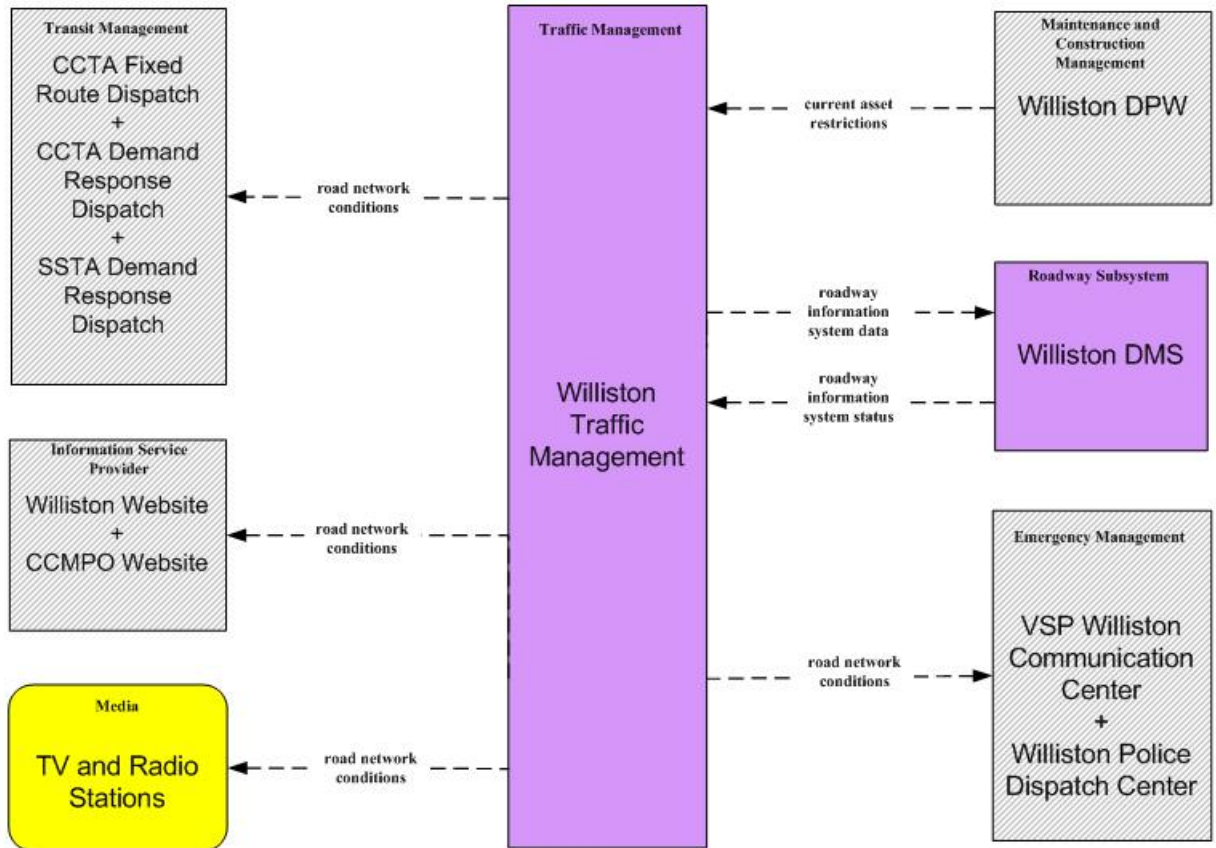

ATMS06 – Traffic Information Dissemination Winooski Traffic Management

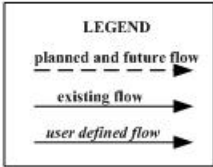
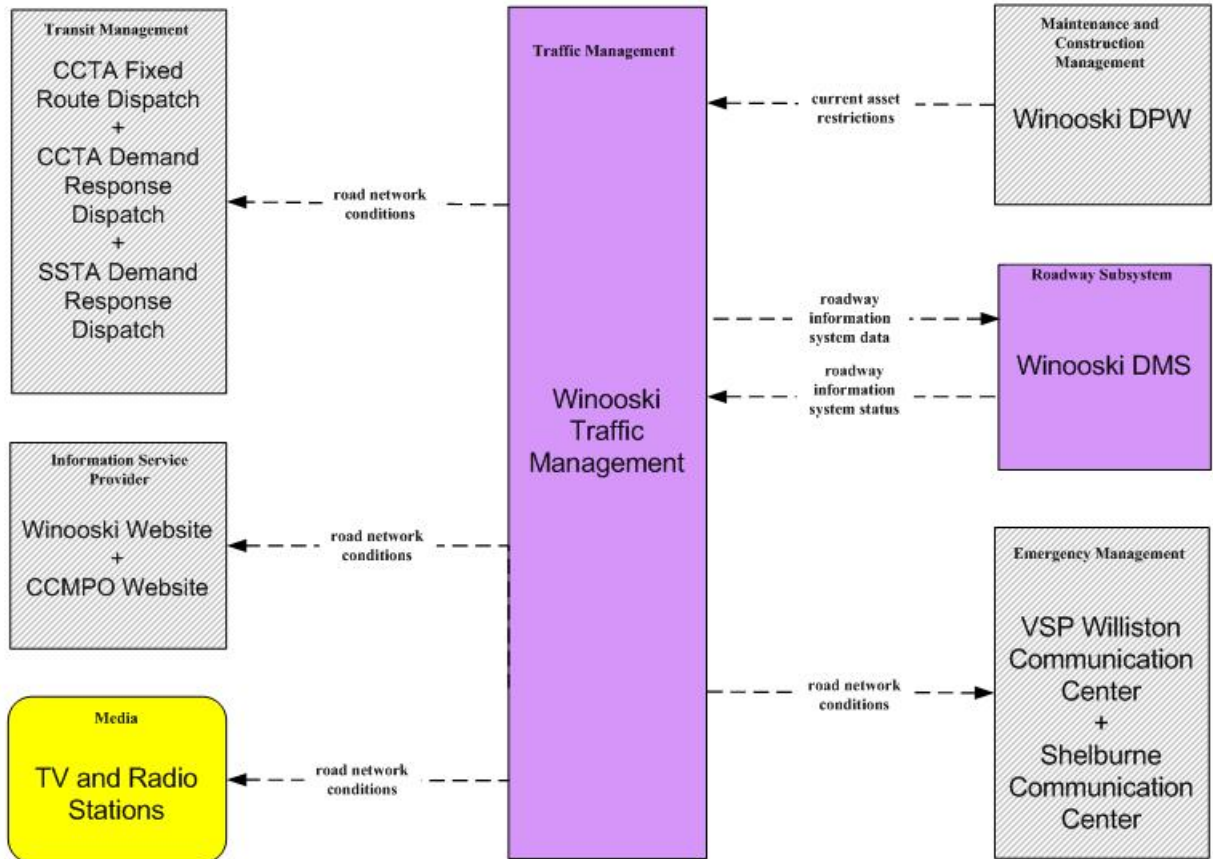

ATMS08 – Incident Management
Chittenden Regional TOC

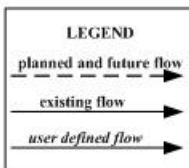
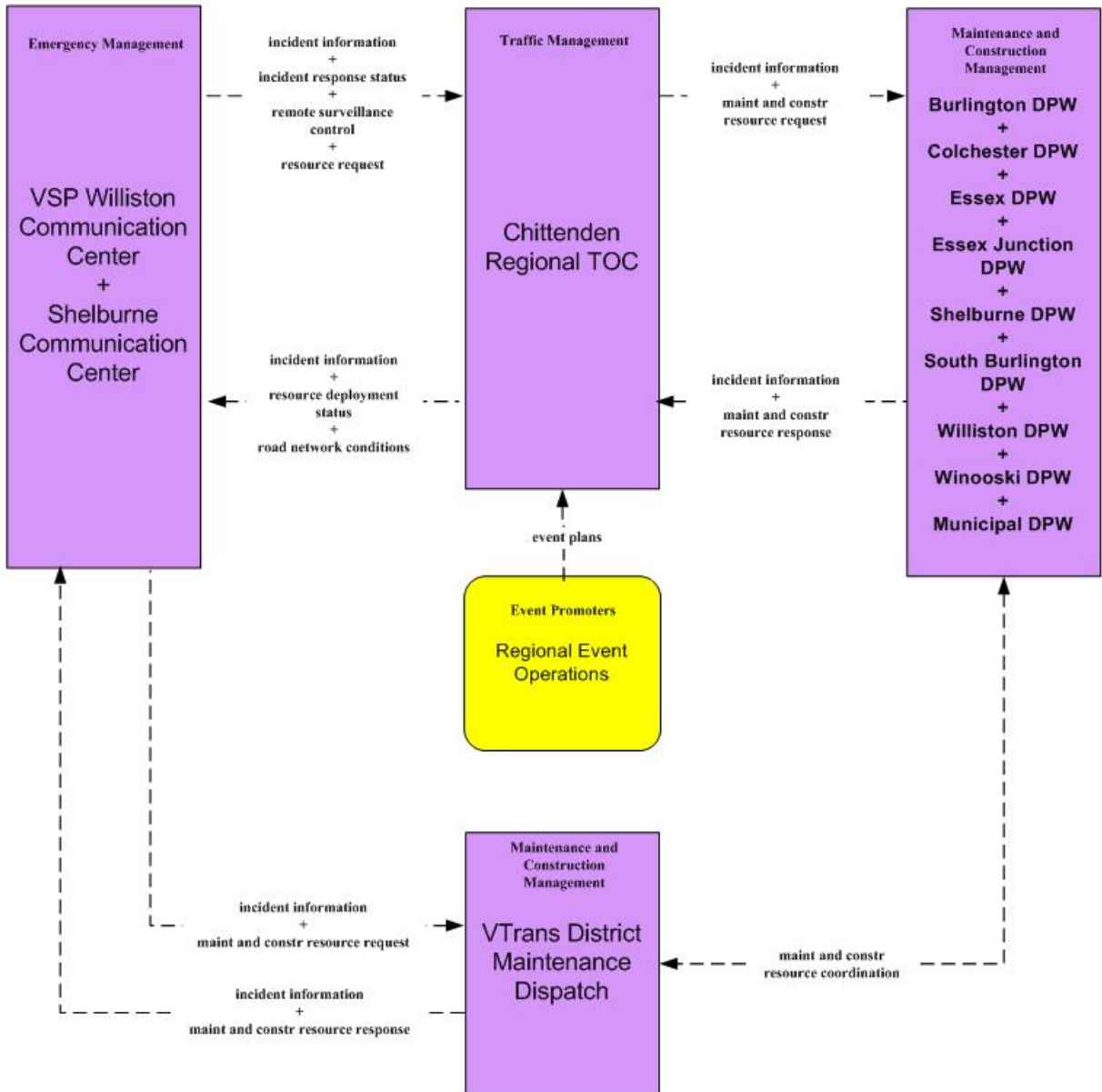

ATMS08 – Incident Management
Rail Operations Centers

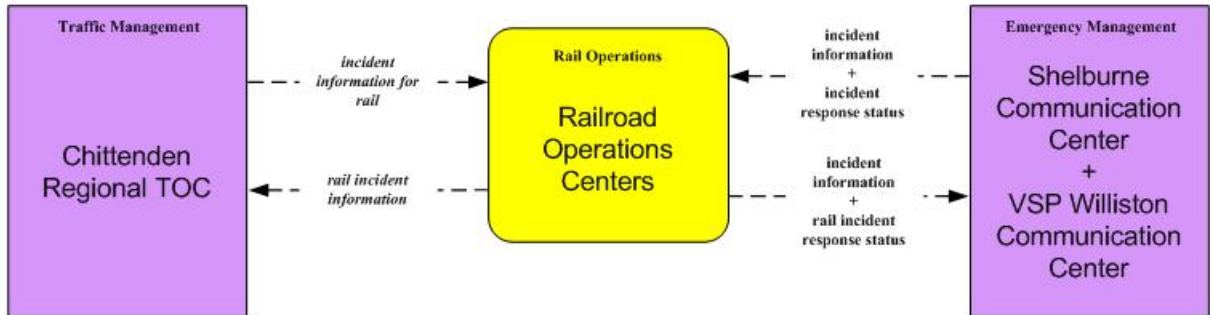

LEGEND

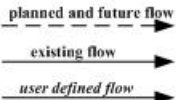

ATMS08 – Incident Management Shelburne Traffic Management

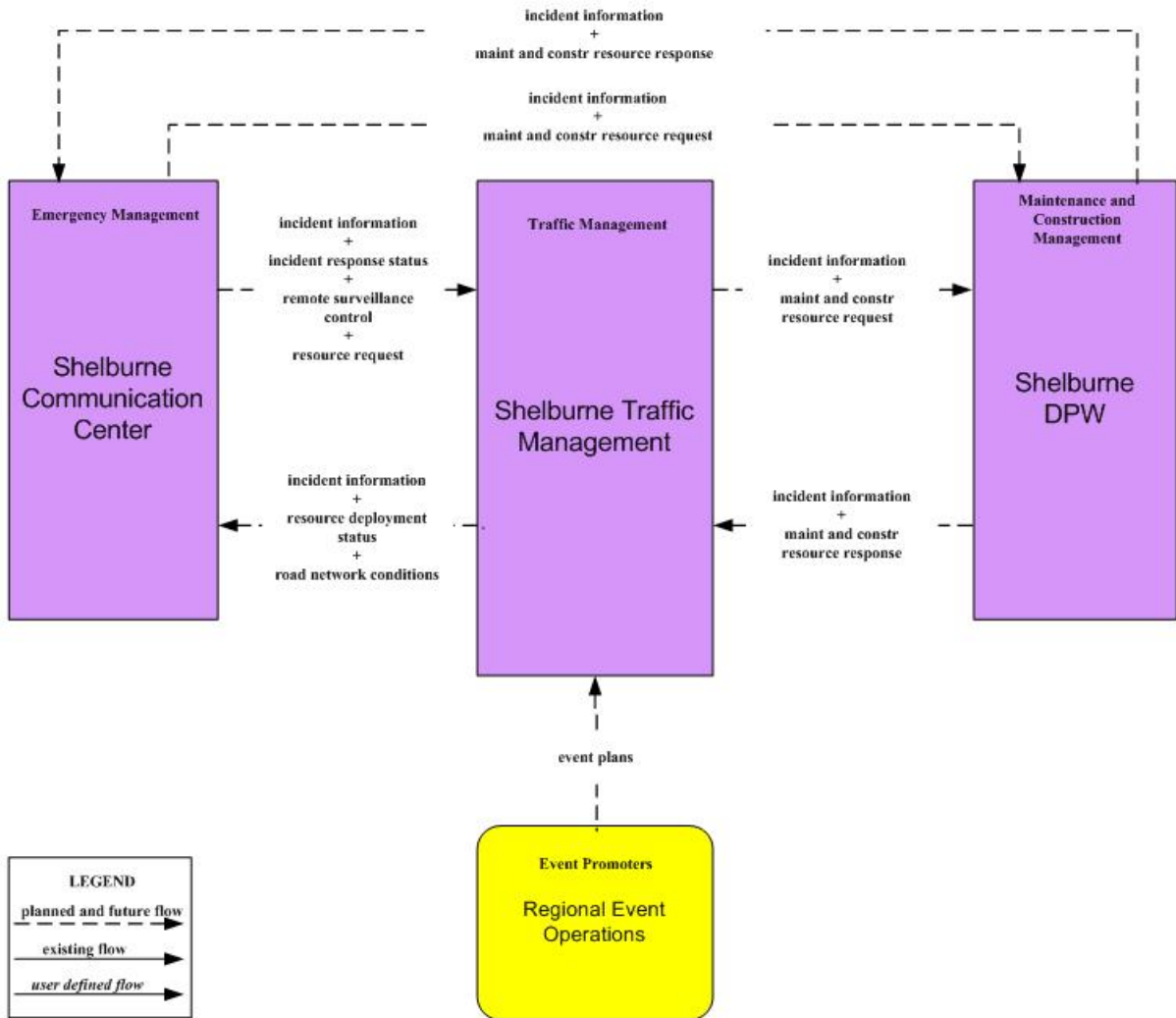

ATMS08 – Incident Management
VTrans State TOC

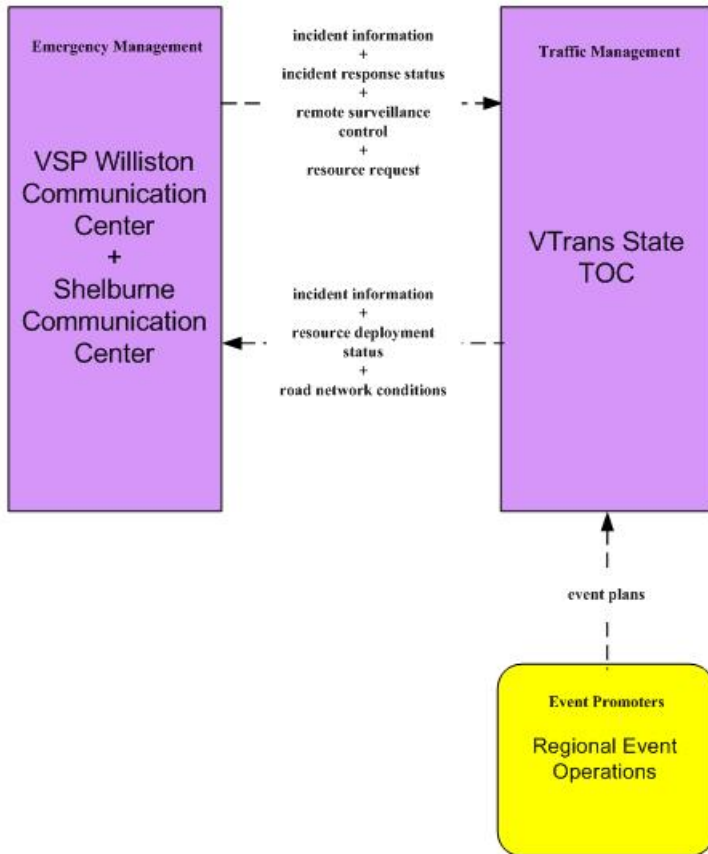

CVO10 - HAZMAT Management Statewide

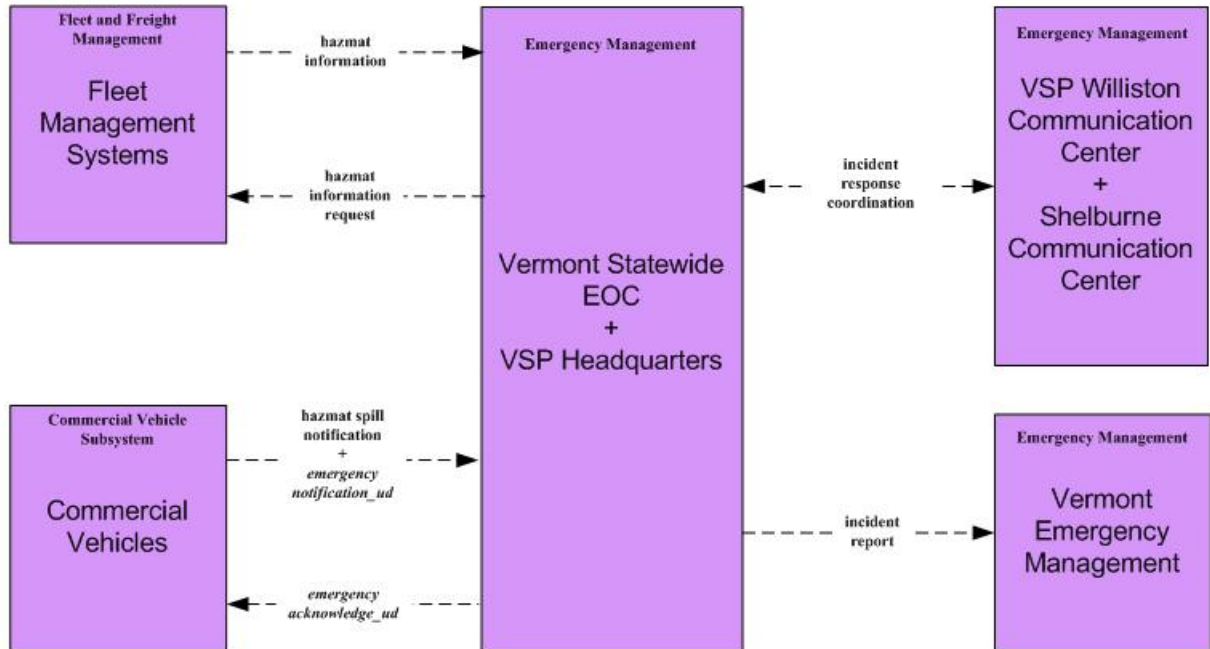

LEGEND

planned and future flow →

existing flow →

user defined flow →

EM01 - Emergency Call-Taking and Dispatch Municipal Dispatch Center

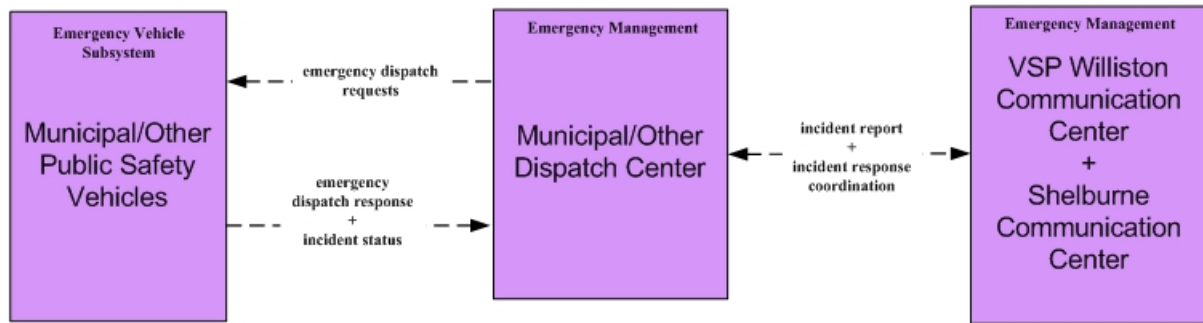

LEGEND

planned and future flow

existing flow

user defined flow

See Market Package EM01 - VSP Williston Communication Center and Shelburne Communication Center instances for detailed call-taking/dispatching activities at each of them.

EM01 - Emergency Call-Taking and Dispatch Statewide Mutual Aid

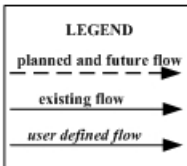
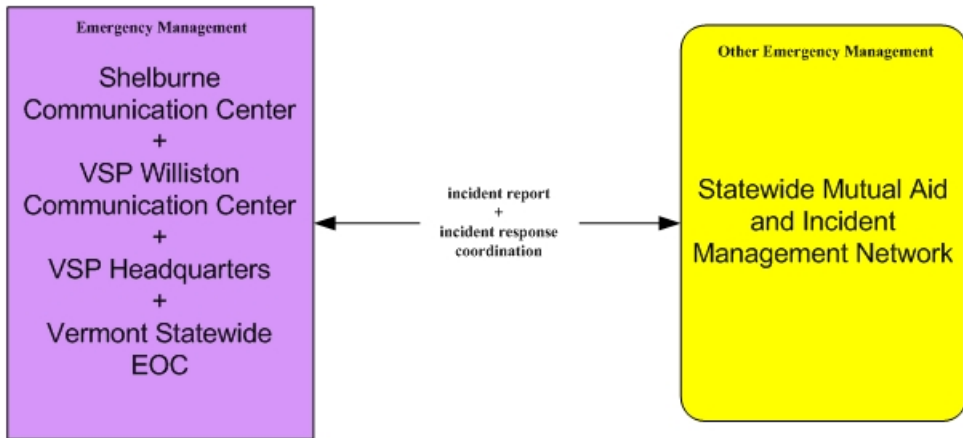

EM01 - Emergency Call-Taking and Dispatch
Shelburne Communication Center

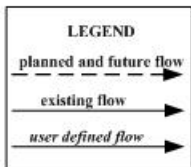
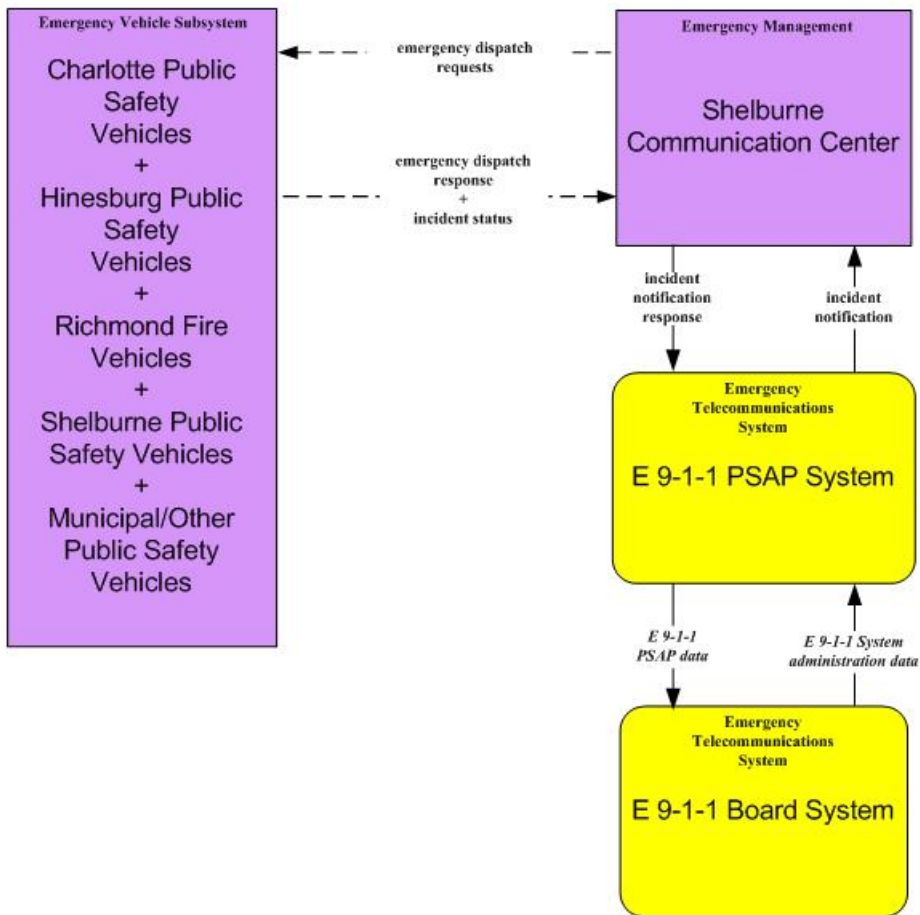

EMO2 – Emergency Routing

2 of 2 – Emergency Management

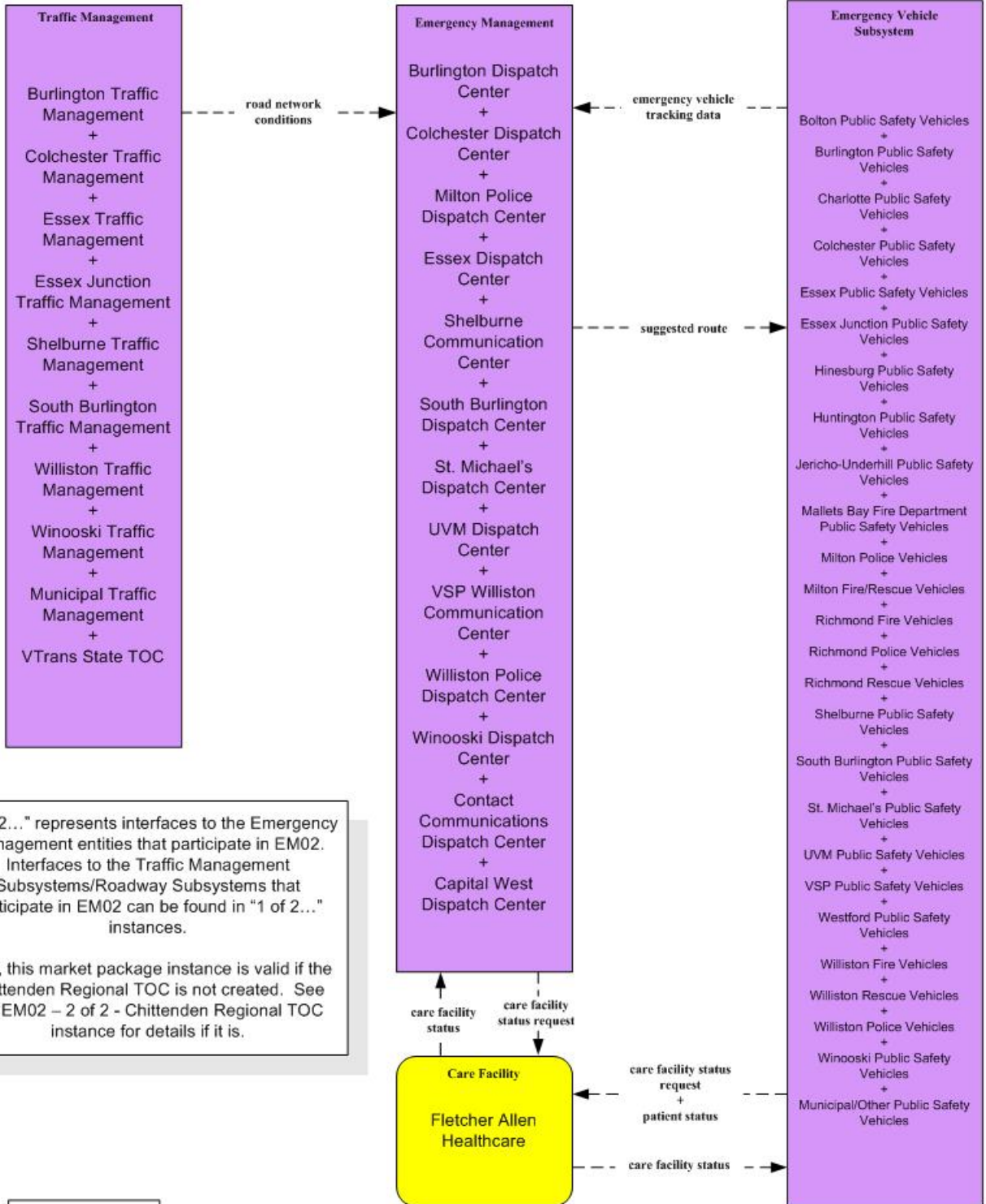

"2 of 2..." represents interfaces to the Emergency Management entities that participate in EM02. Interfaces to the Traffic Management Subsystems/Roadway Subsystems that participate in EM02 can be found in "1 of 2..." instances.

Also, this market package instance is valid if the Chittenden Regional TOC is not created. See the EM02 – 2 of 2 - Chittenden Regional TOC instance for details if it is.

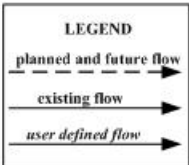

EMO2 – Emergency Routing

2 of 2 - Emergency Management – Chittenden Regional TOC

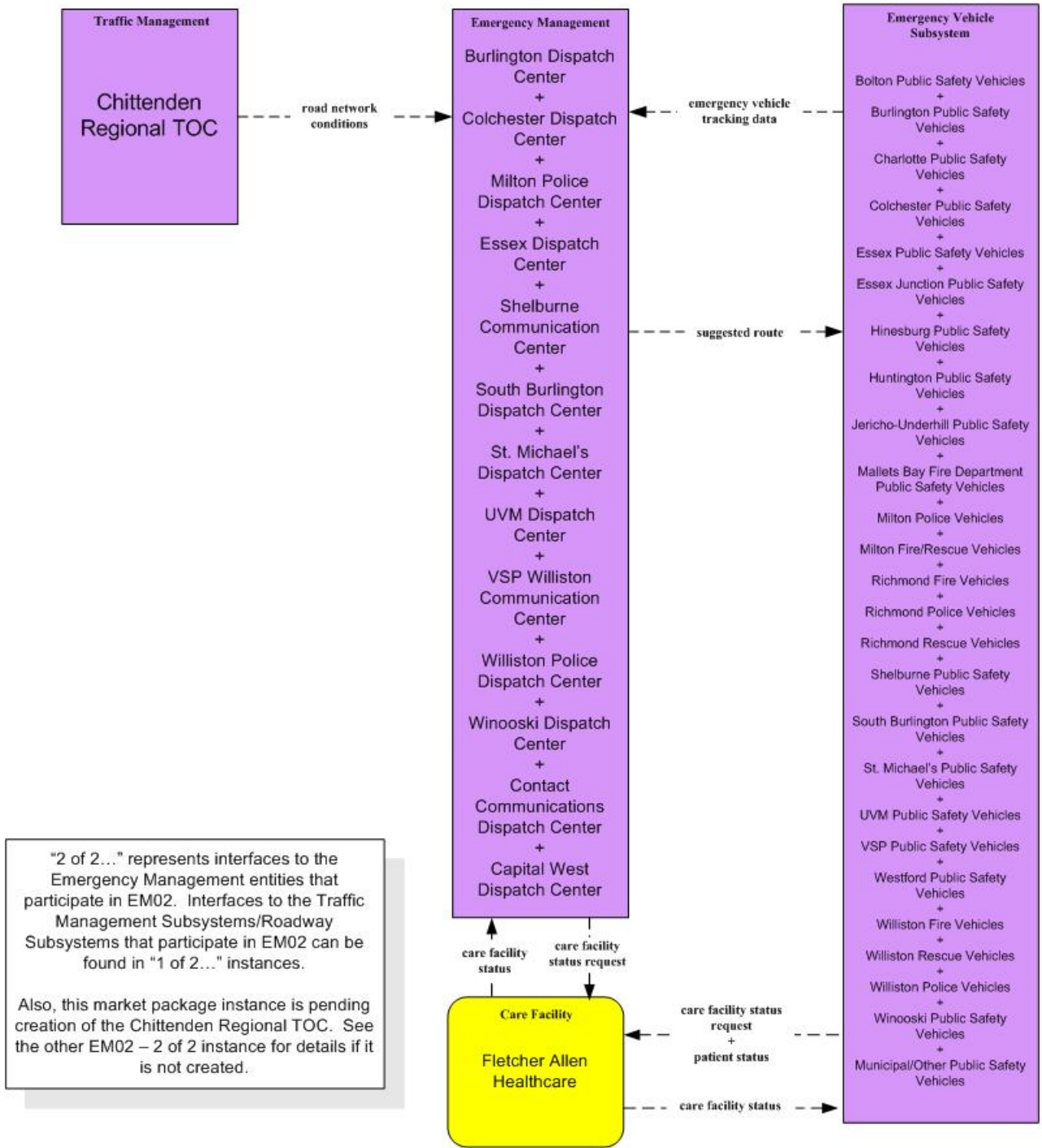

"2 of 2..." represents interfaces to the Emergency Management entities that participate in EM02. Interfaces to the Traffic Management Subsystems/Roadway Subsystems that participate in EM02 can be found in "1 of 2..." instances.

Also, this market package instance is pending creation of the Chittenden Regional TOC. See the other EM02 – 2 of 2 instance for details if it is not created.

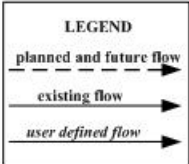

**EMO6 – Wide Area Alert
Vermont Statewide EOC & VSP Headquarters**

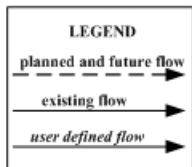
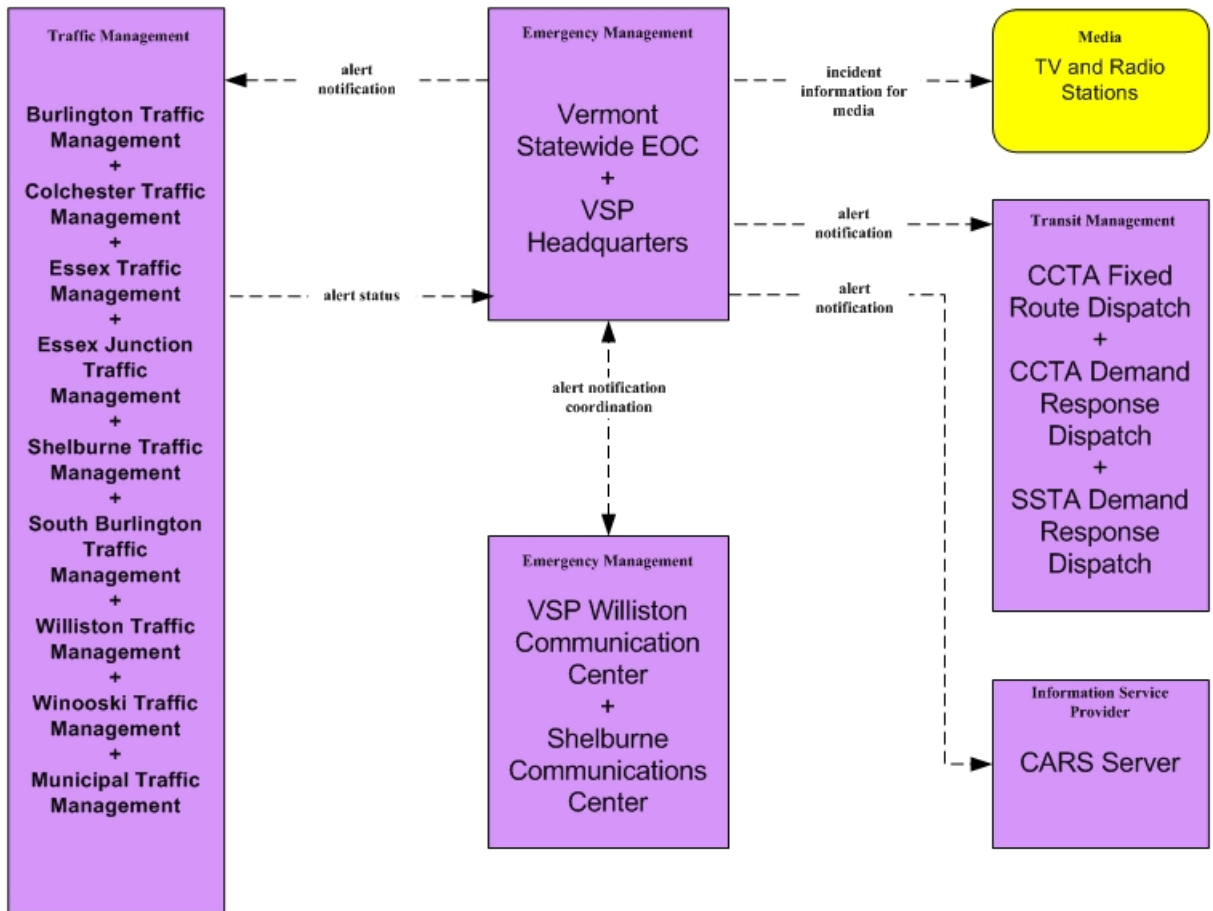

EMO6 – Wide Area Alert
 Vermont Statewide EOC & VSP Headquarters – Chittenden Regional TOC

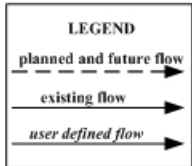
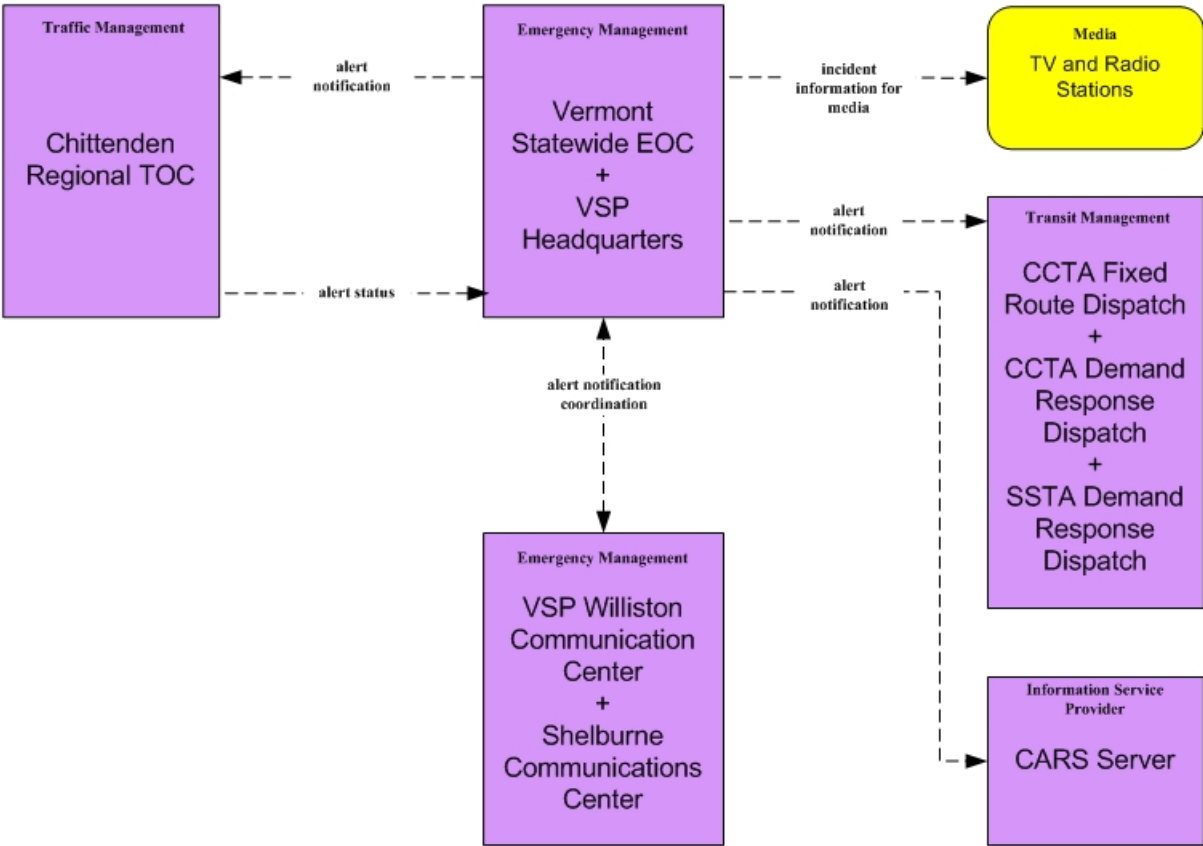

EM09 - Evacuation and Reentry Management
Vermont Statewide EOC

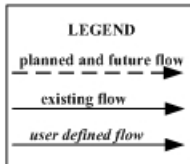
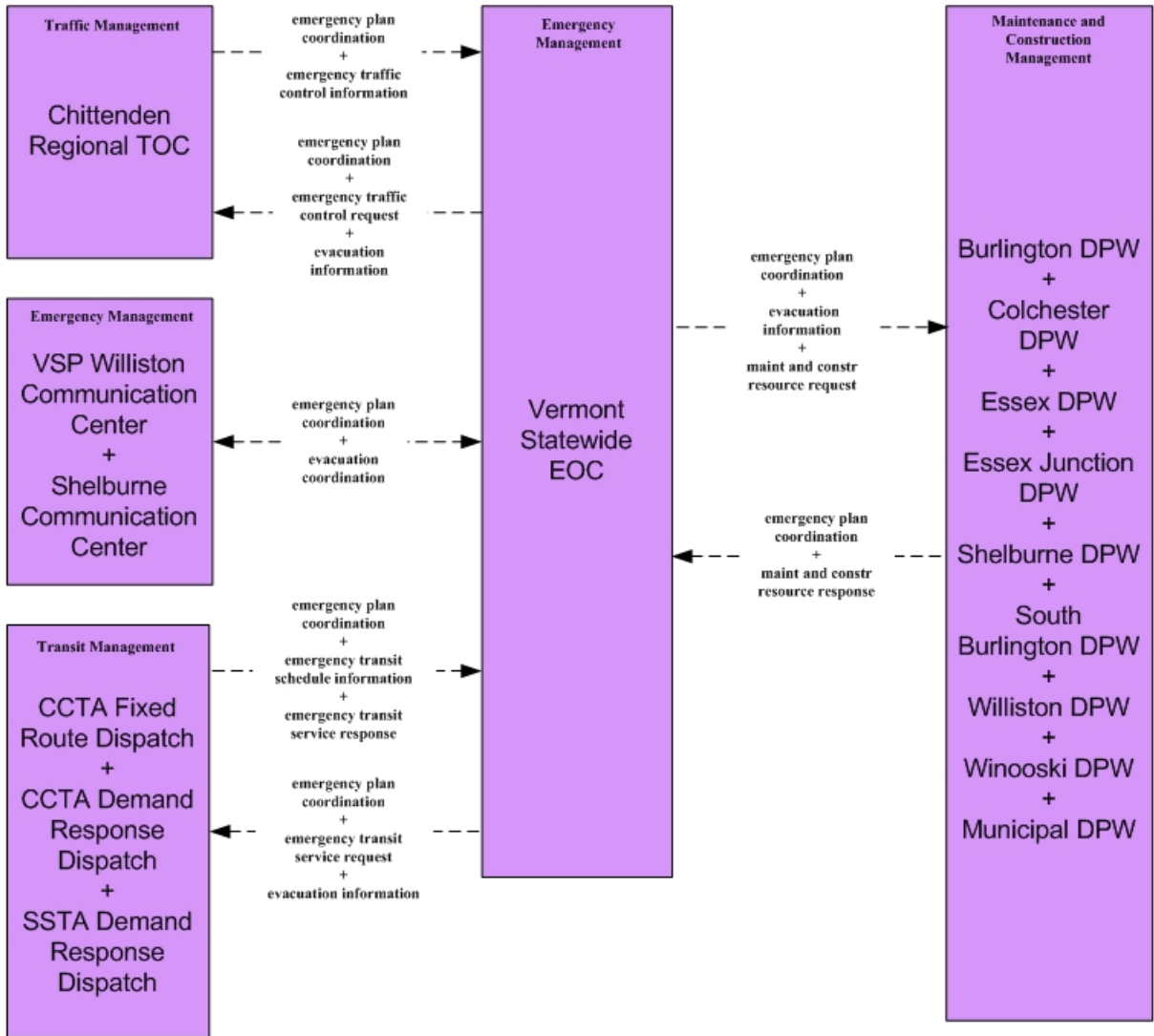

MC04 - Weather Information Processing and Distribution
CARS

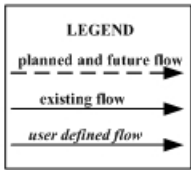
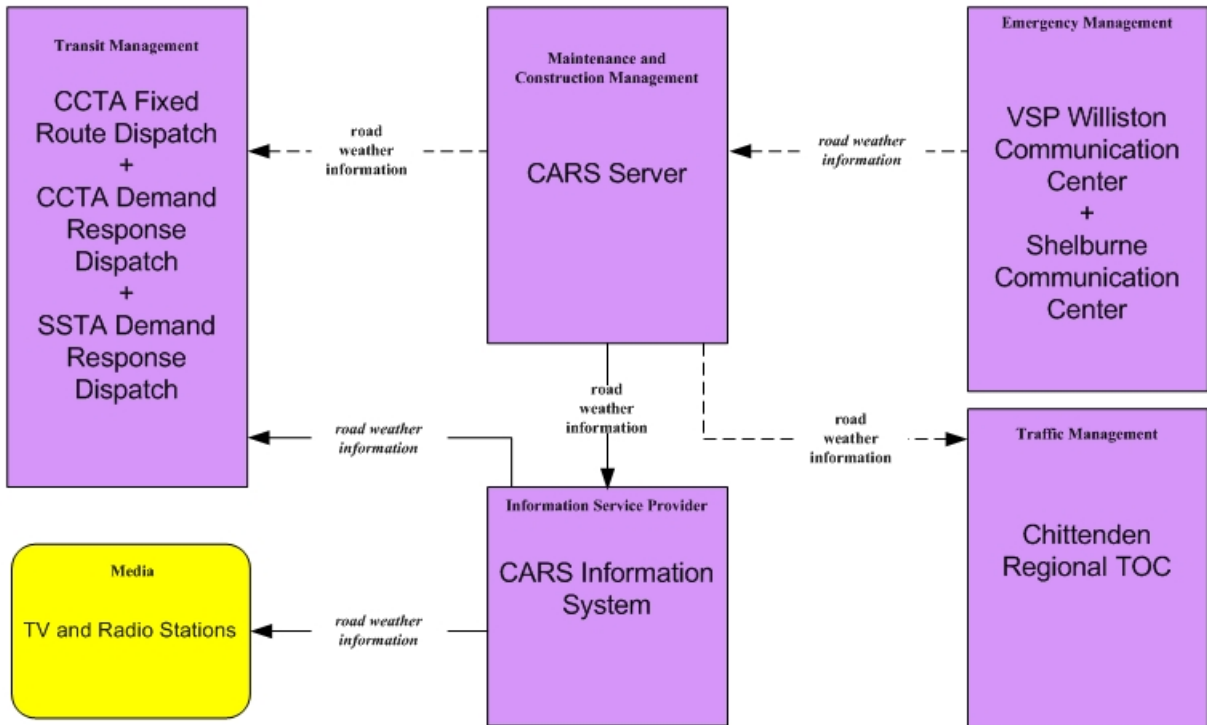

MC04 – Weather Information Processing and Distribution
Chittenden Regional TOC

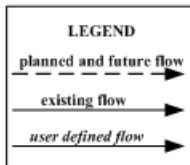
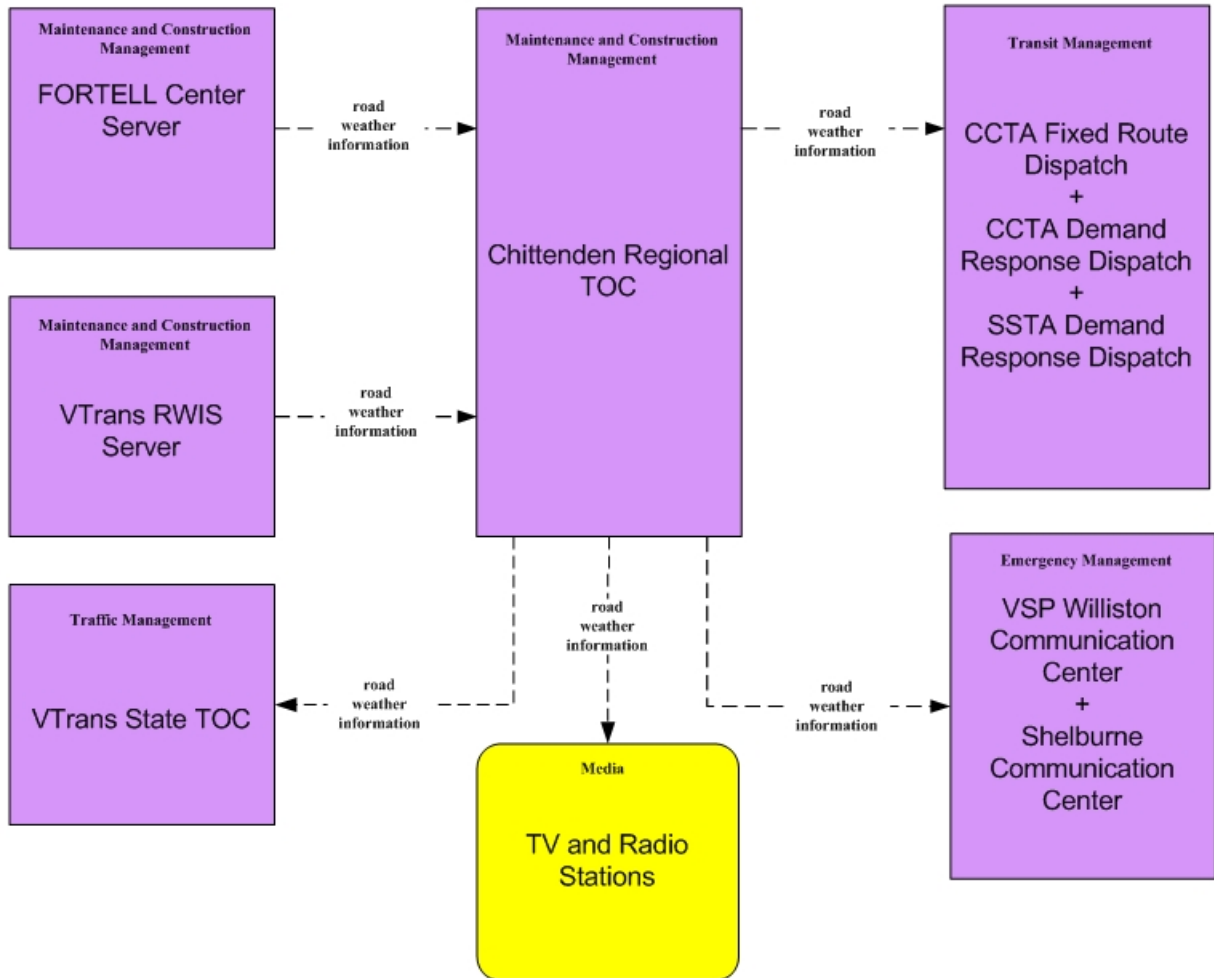

MC04 - Weather Information Processing and Distribution
Weather Services

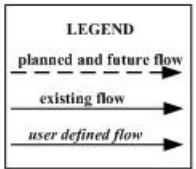
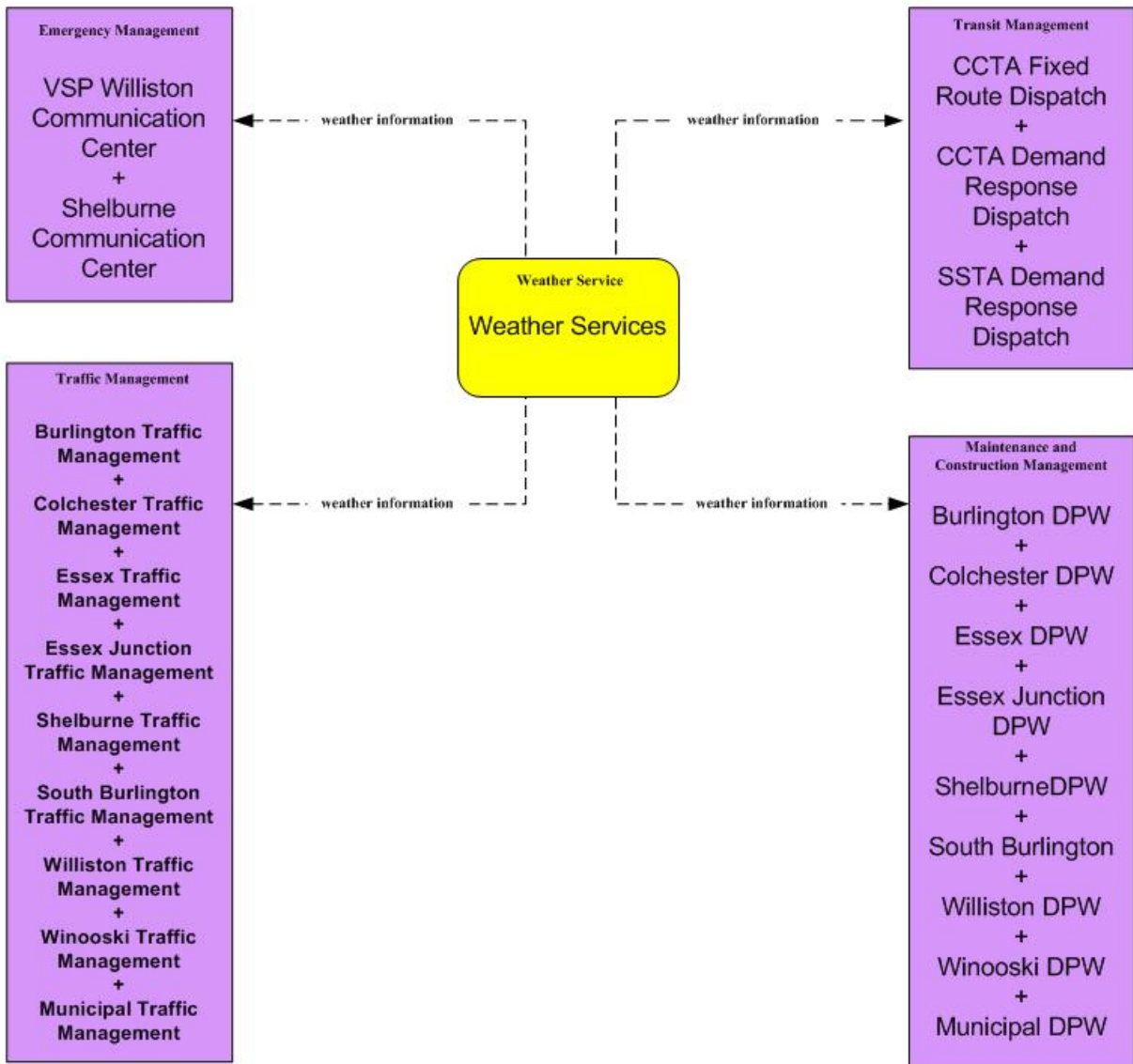

This instance represents the situation for this market package with existing entities only. See the MC04 – Weather Services (Chittenden Regional TOC) instance for market package details pending creation of the Chittenden Regional TOC.

MC04 - Weather Information Processing and Distribution
Weather Services – Chittenden Regional TOC

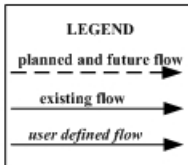
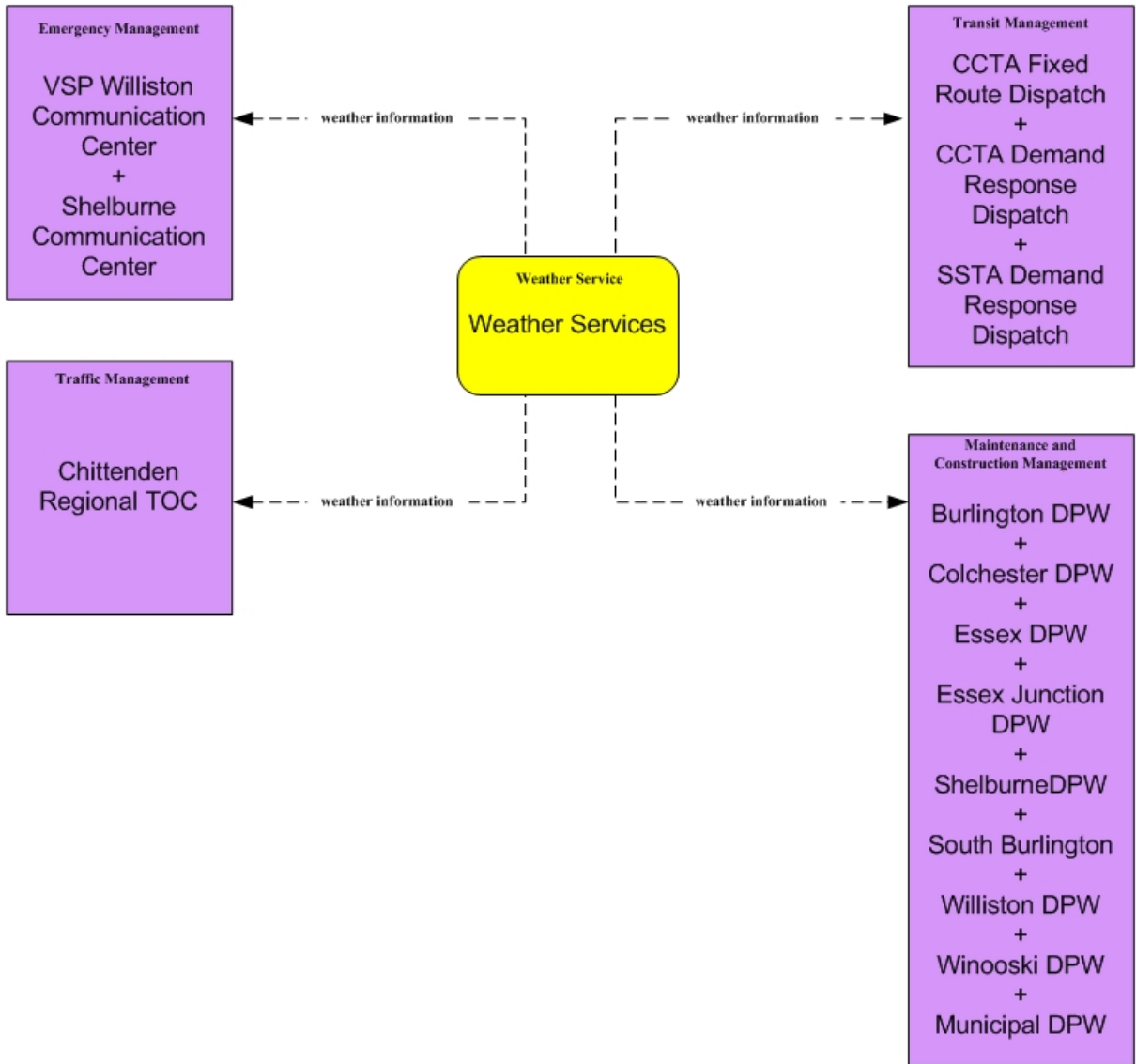

This instance represents the situation for this market package pending creation of the Chittenden Regional TOC. See the MC04 – Weather Services instance for market package details with existing entities only.

MC06 - Winter Maintenance
Burlington DPW

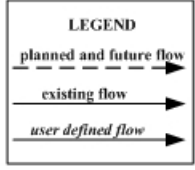
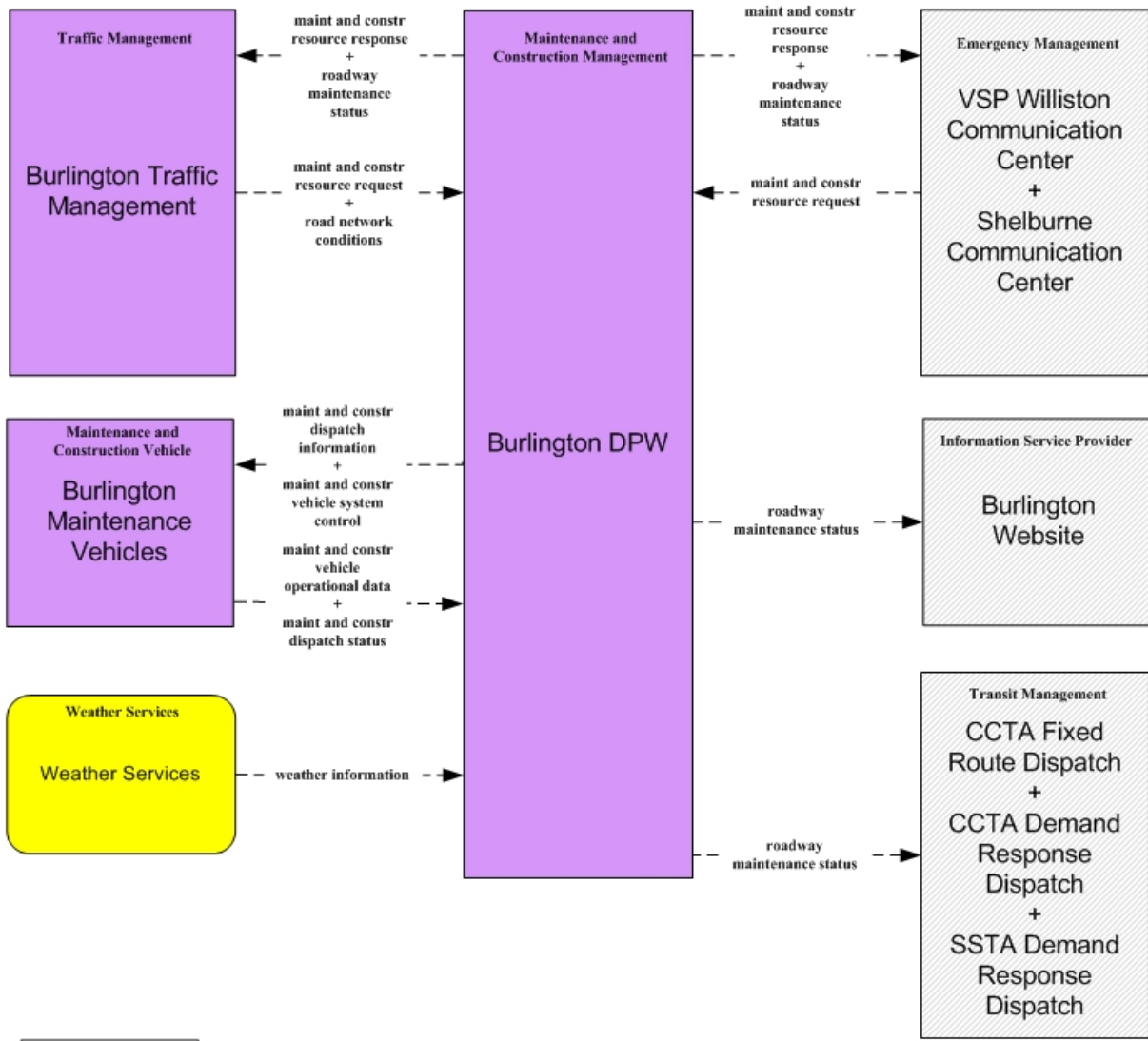

MC06 - Winter Maintenance
Colchester DPW

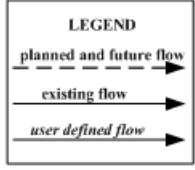
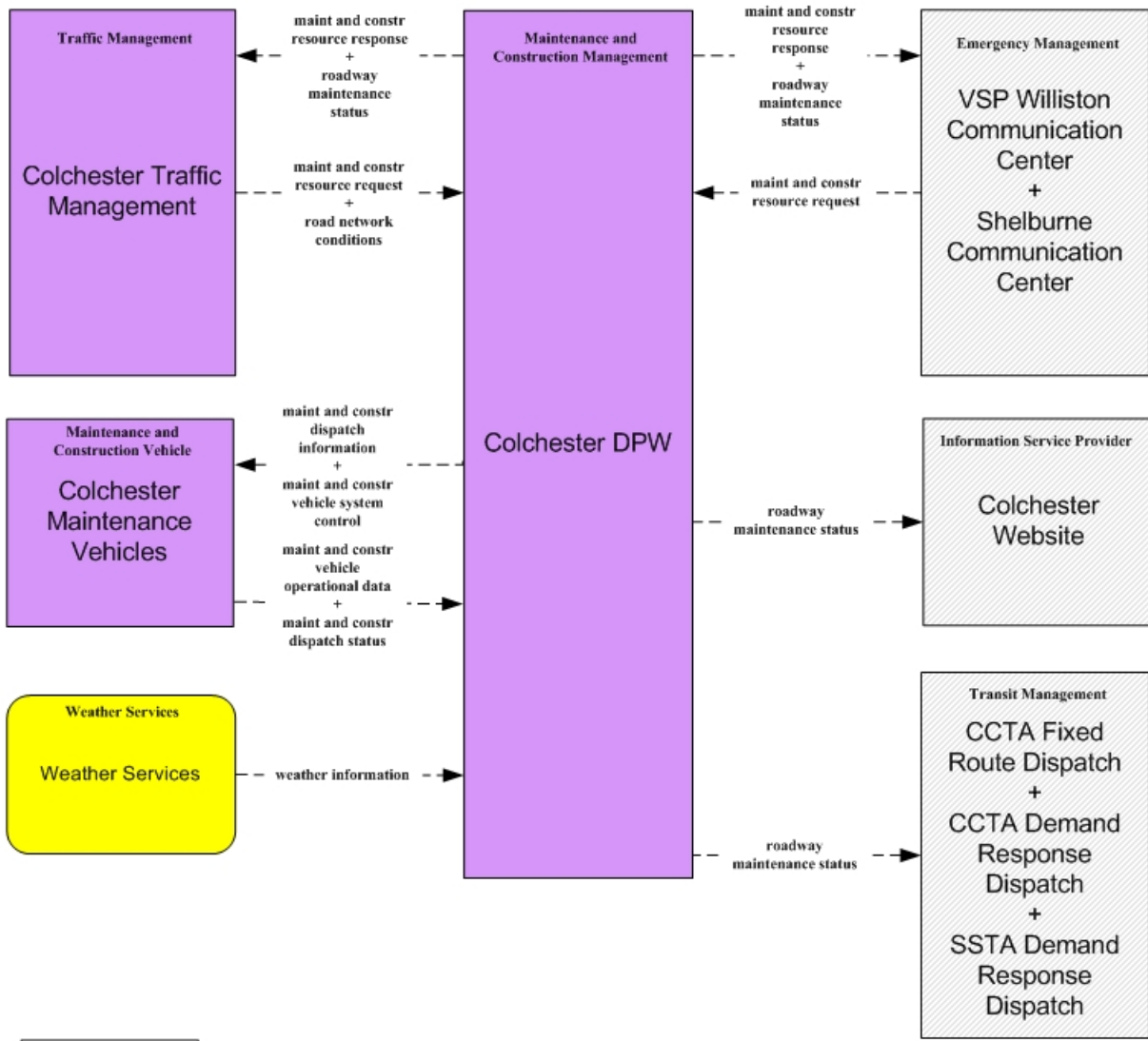

MC06 - Winter Maintenance
Essex DPW

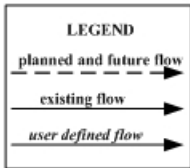
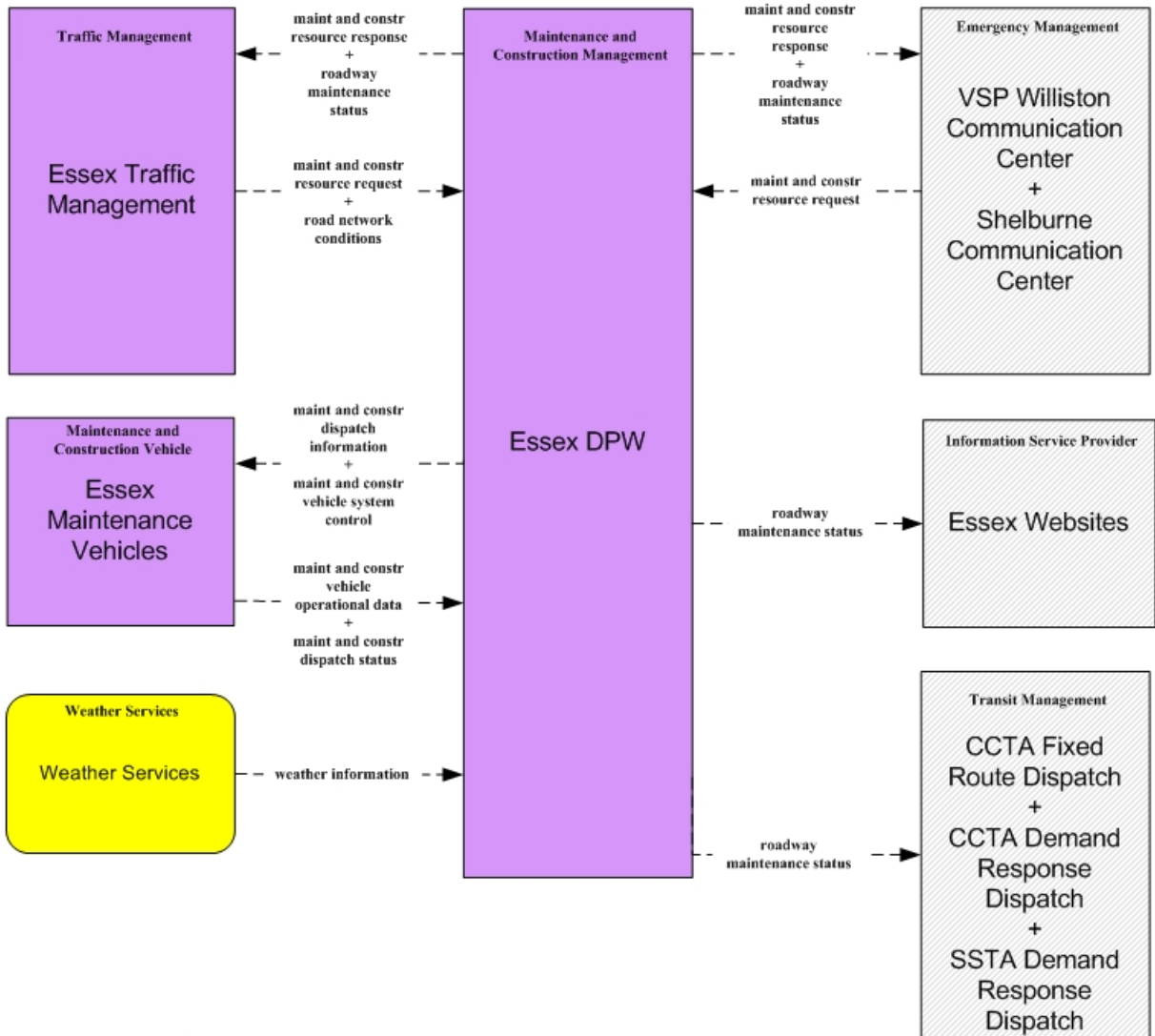

MC06 - Winter Maintenance
Essex Junction DPW

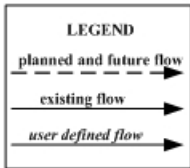
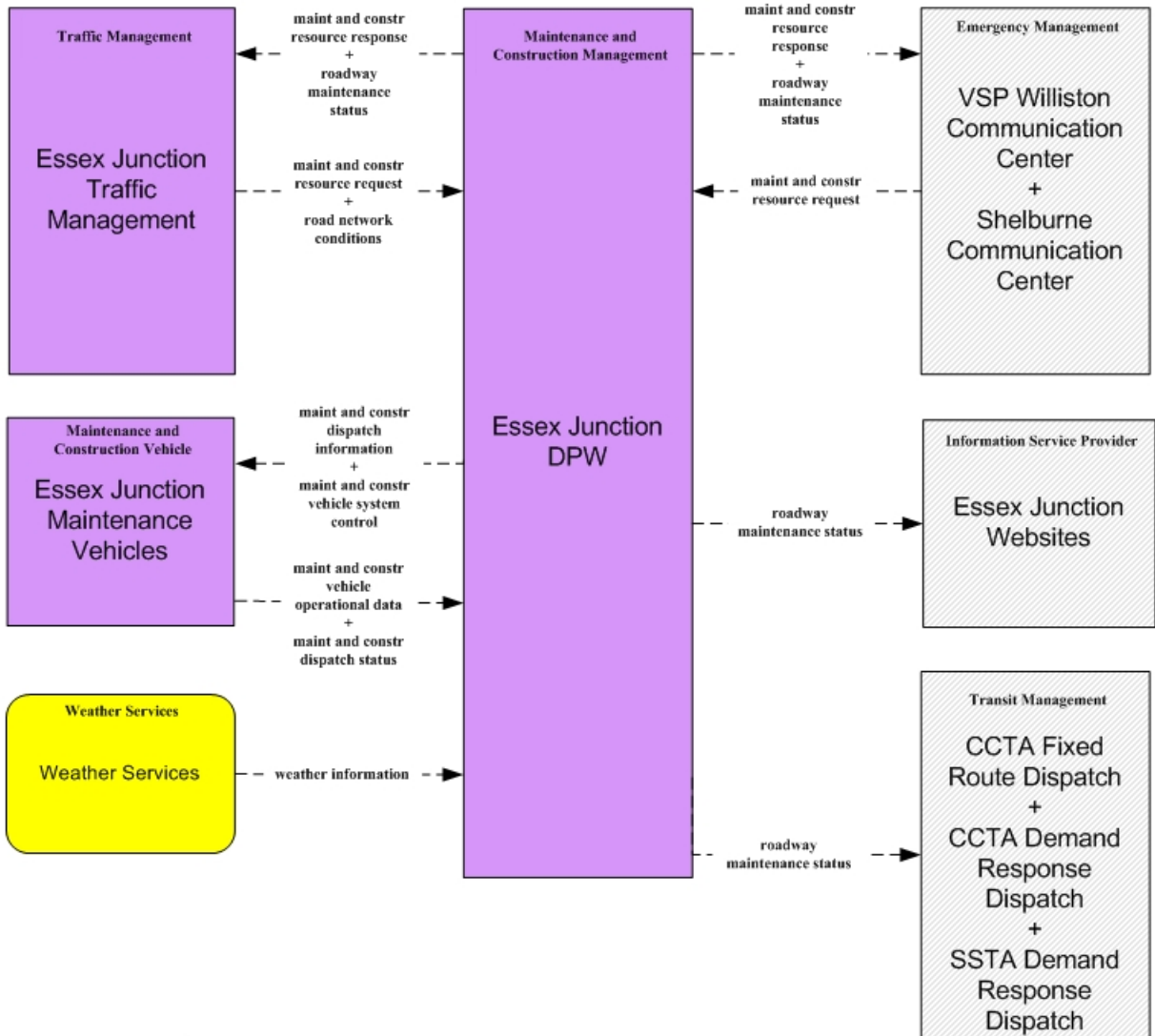

MC06 - Winter Maintenance
Municipal DPW

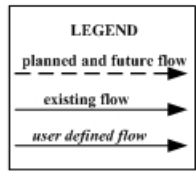
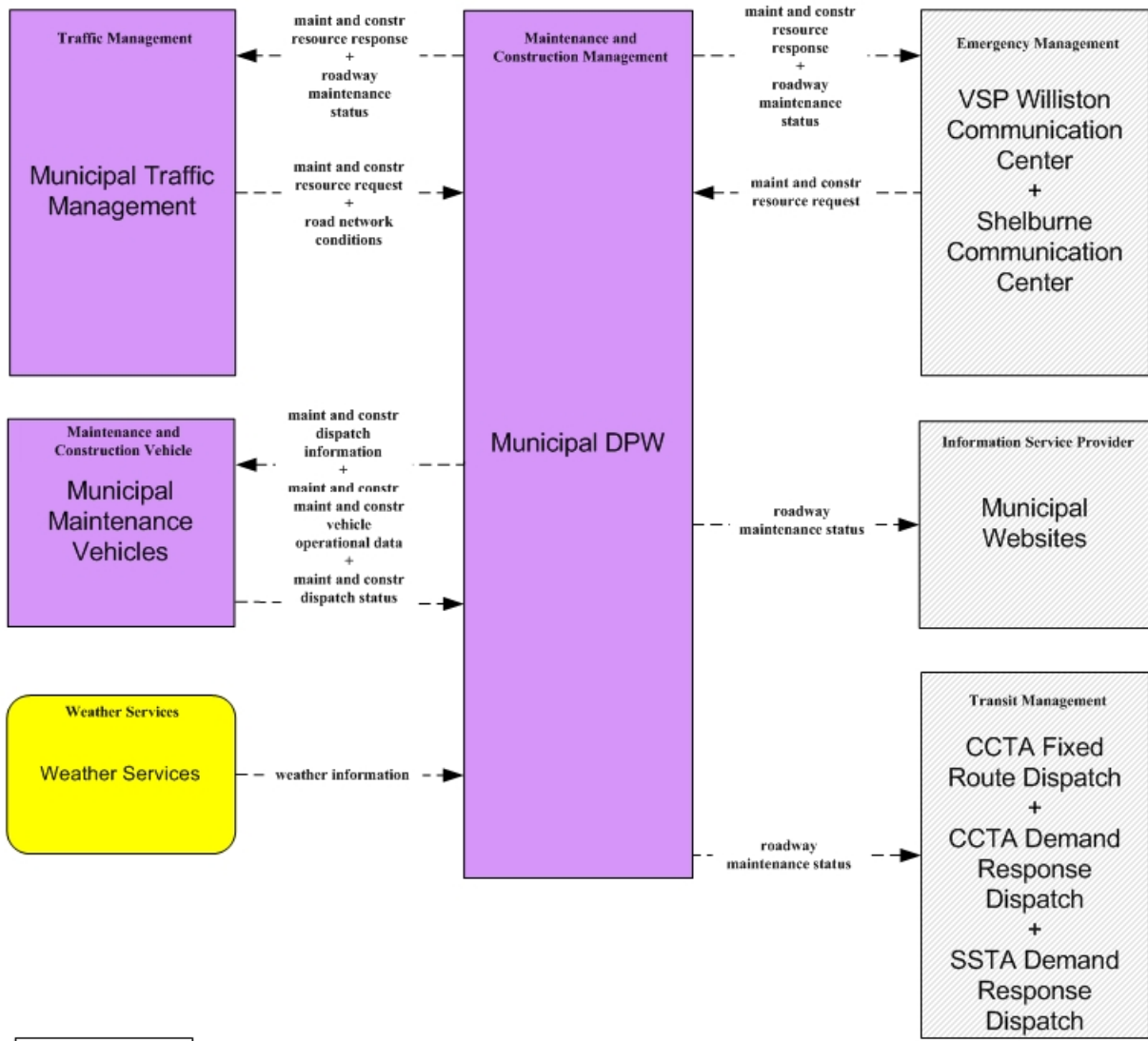

MC06 - Winter Maintenance
Shelburne DPW

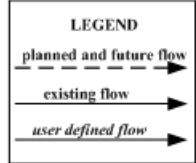
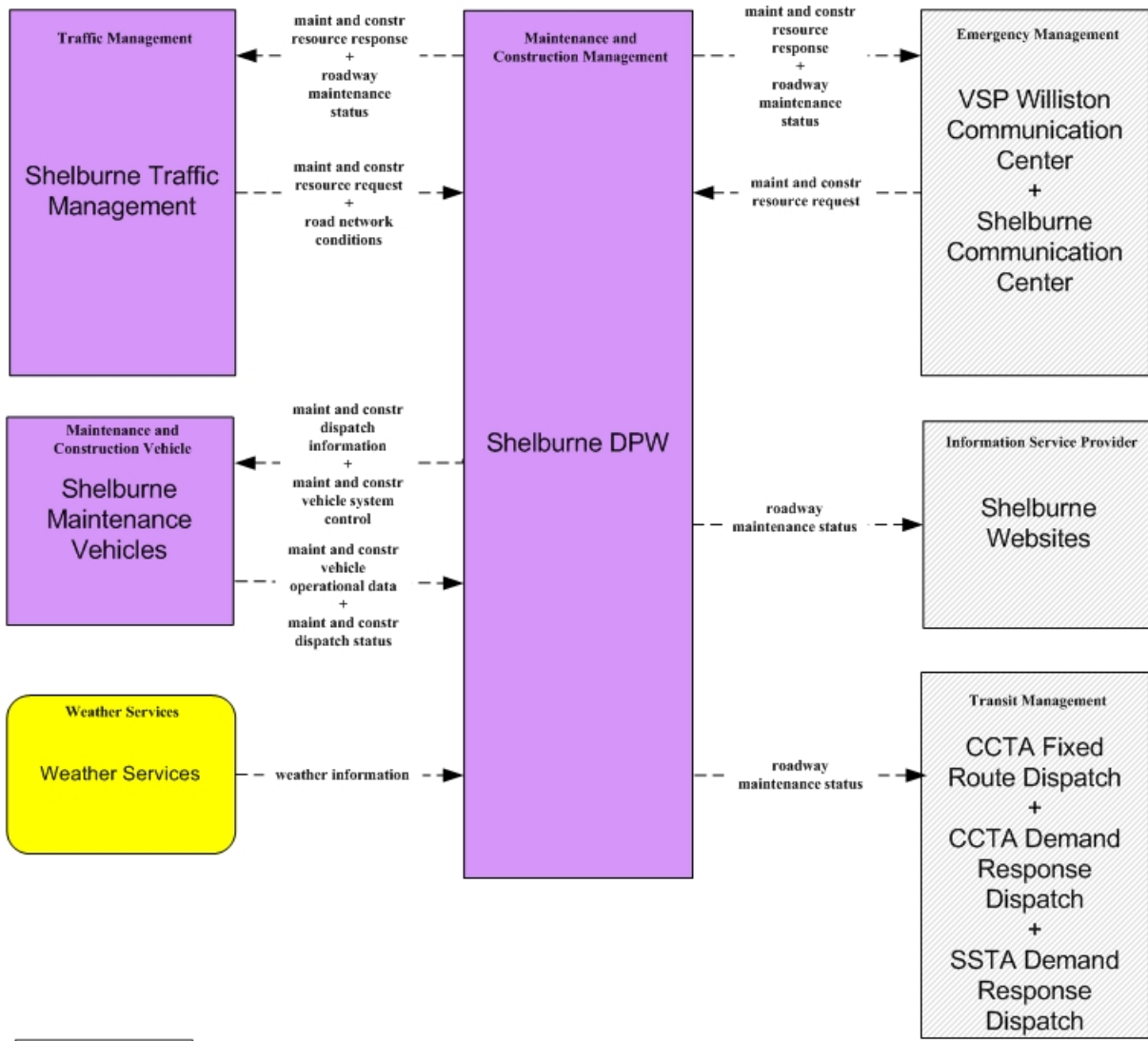

MC06 - Winter Maintenance
South Burlington DPW

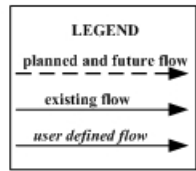
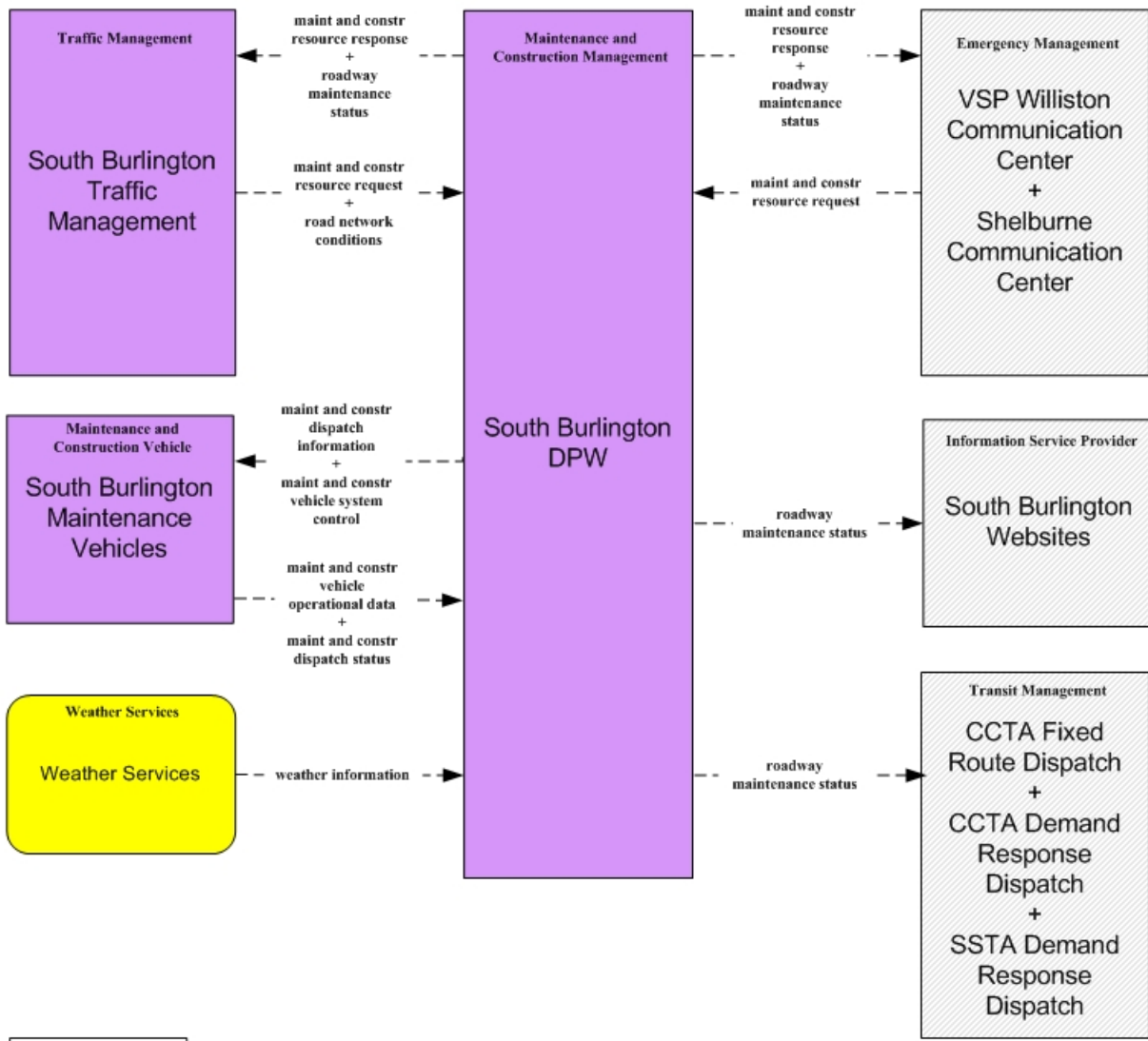

MC06 - Winter Maintenance
Williston DPW

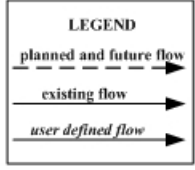
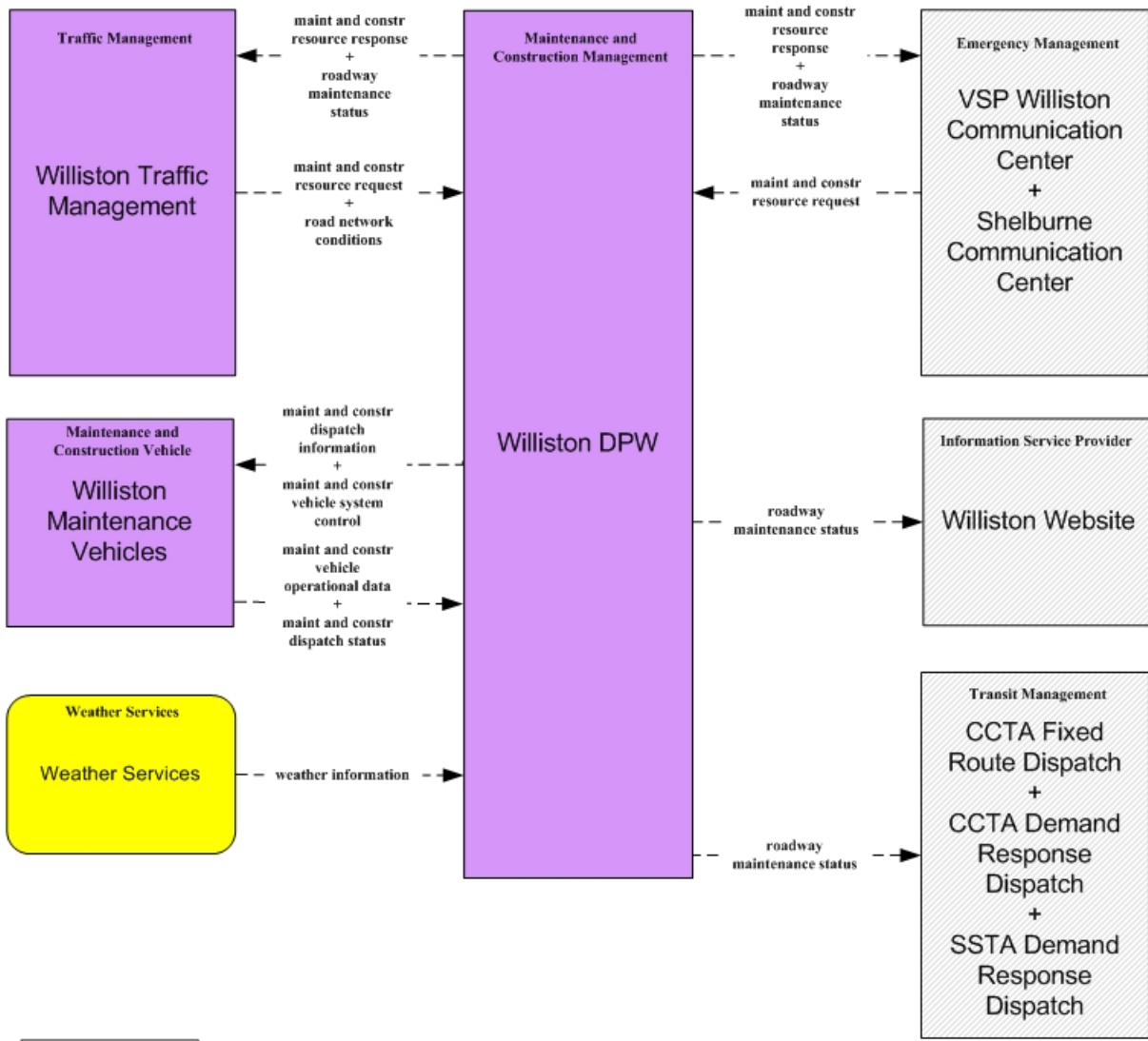

MC06 - Winter Maintenance
Winooski DPW

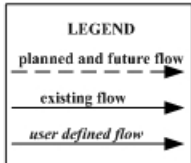
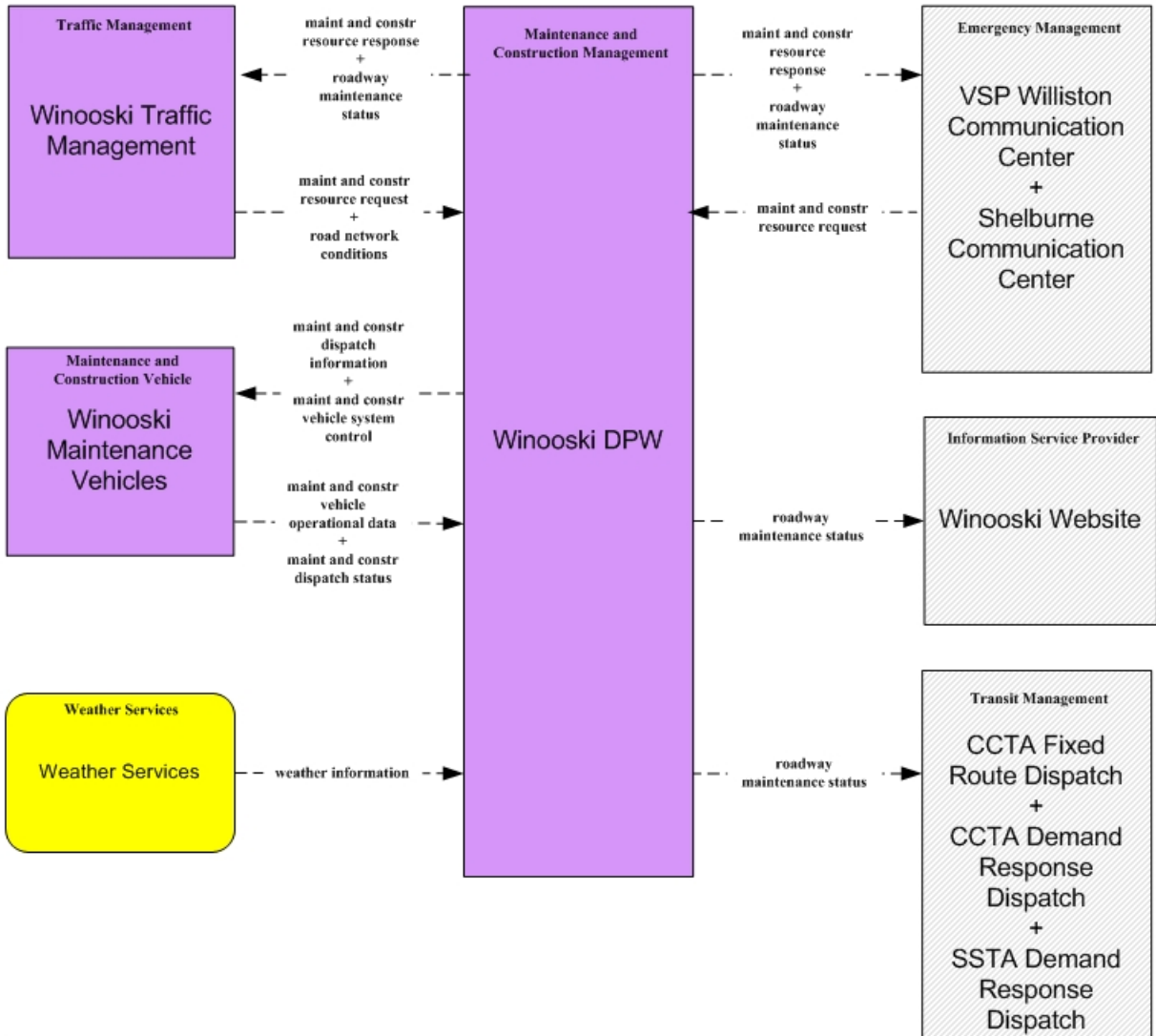

MC08 - Work Zone Management
VTrans District Maintenance Dispatch

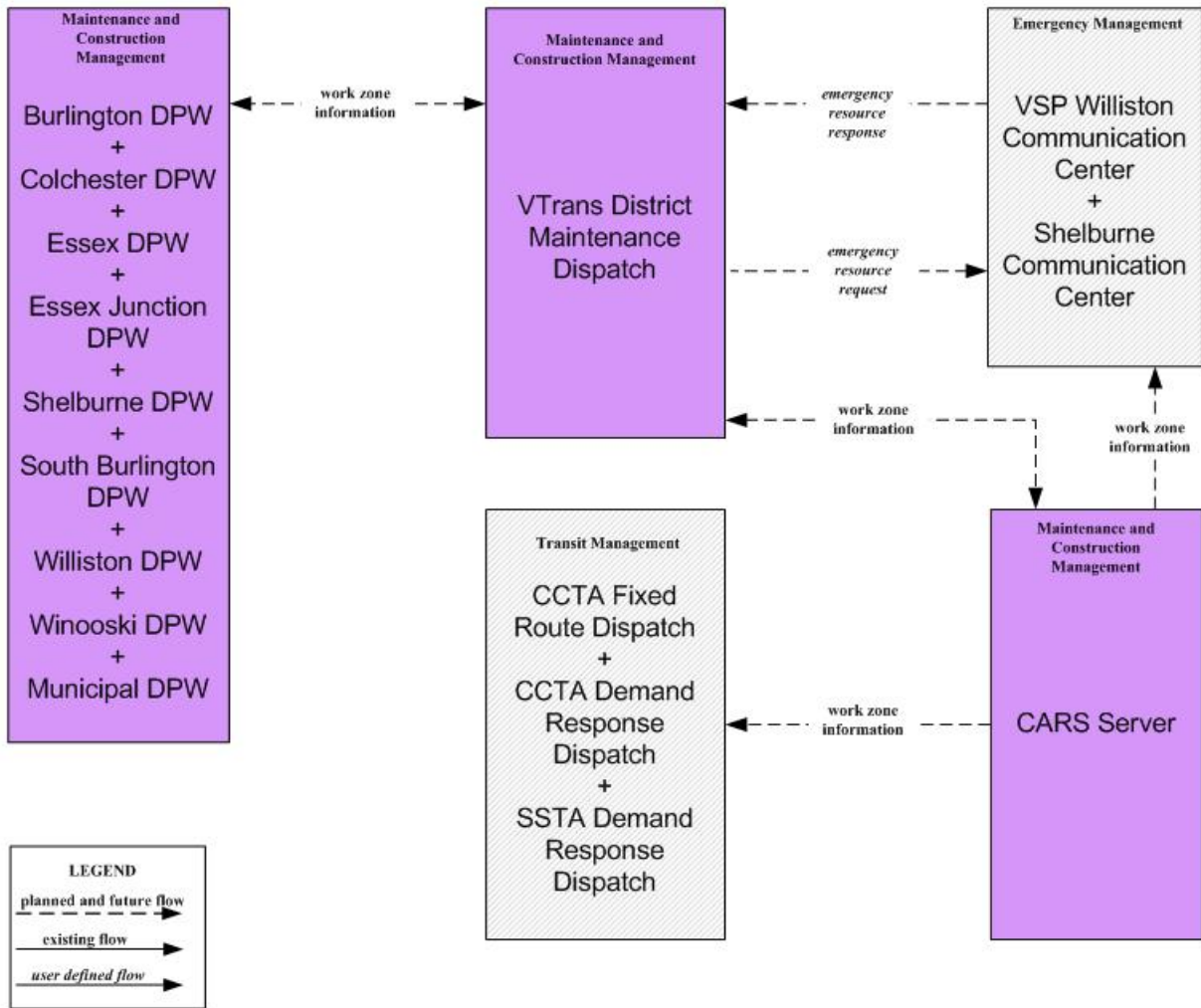

MC10 – Maintenance and Construction Activity Coordination
CARS Server

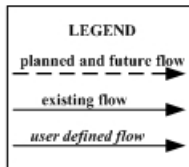
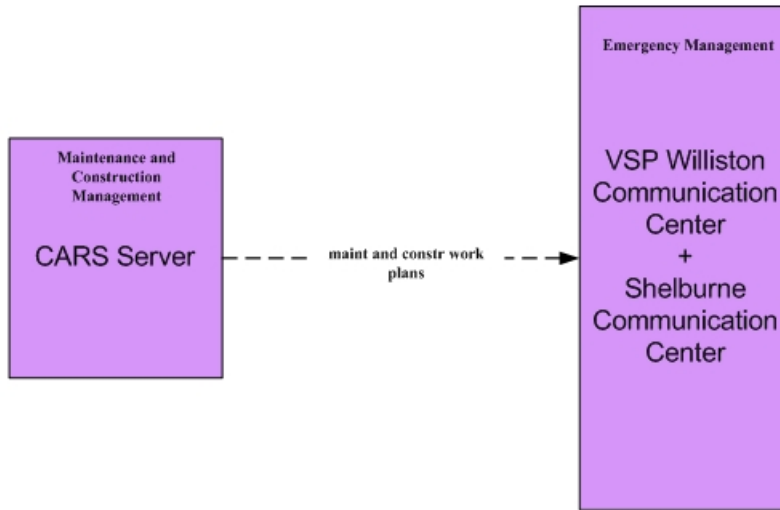

MC10 – Maintenance and Construction Activity Coordination
Shelburne DPW

