

AD1 - ITS Data Mart
South Burlington Data Repository

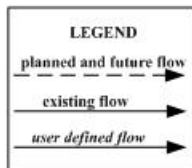

AD2 - ITS Data Warehouse
CCMPO Data Warehouse

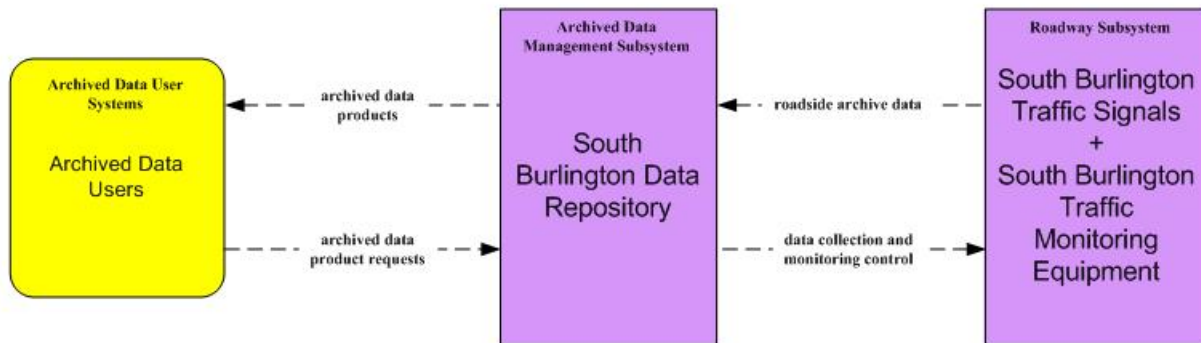
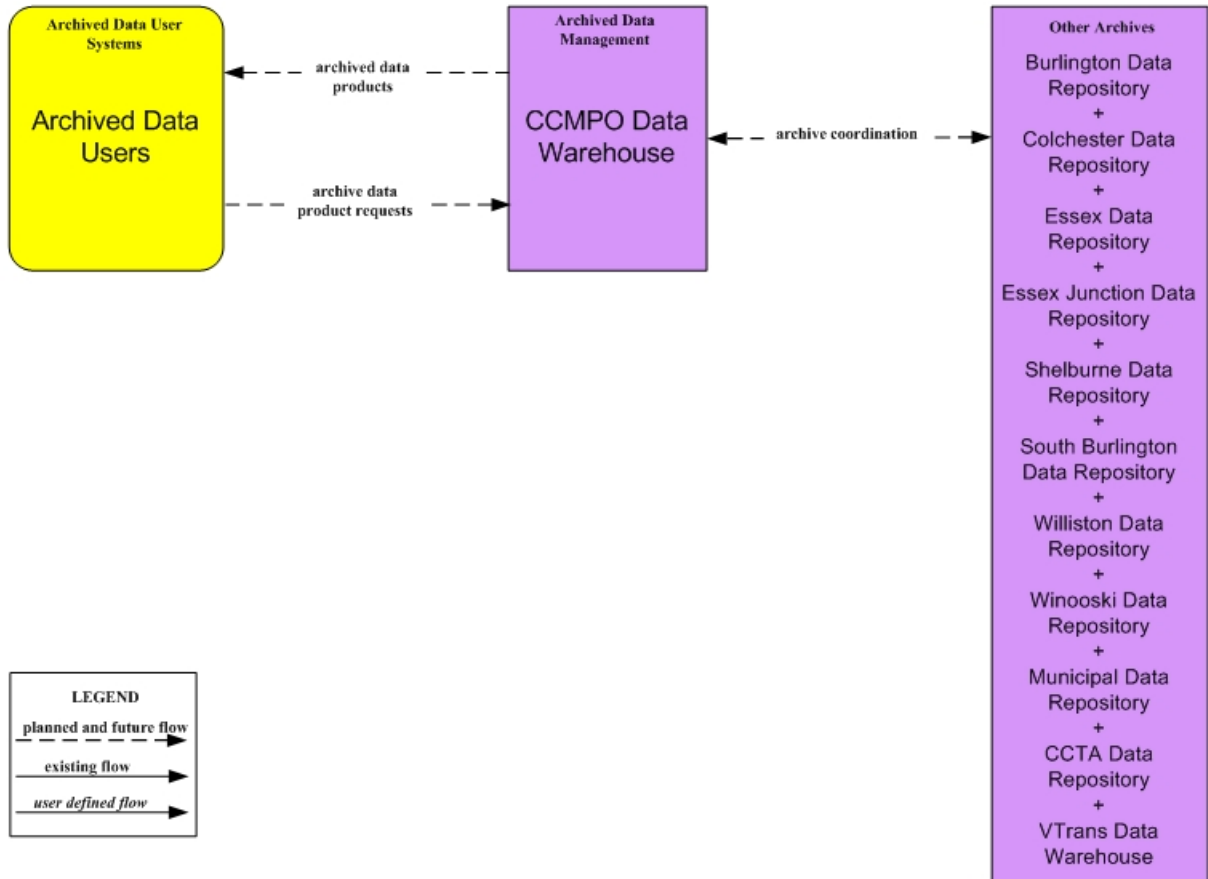

APTS7 – Multimodal Coordination
CCTA Fixed Route Dispatch – Chittenden Regional TOC and VTrans State TOC

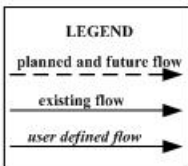
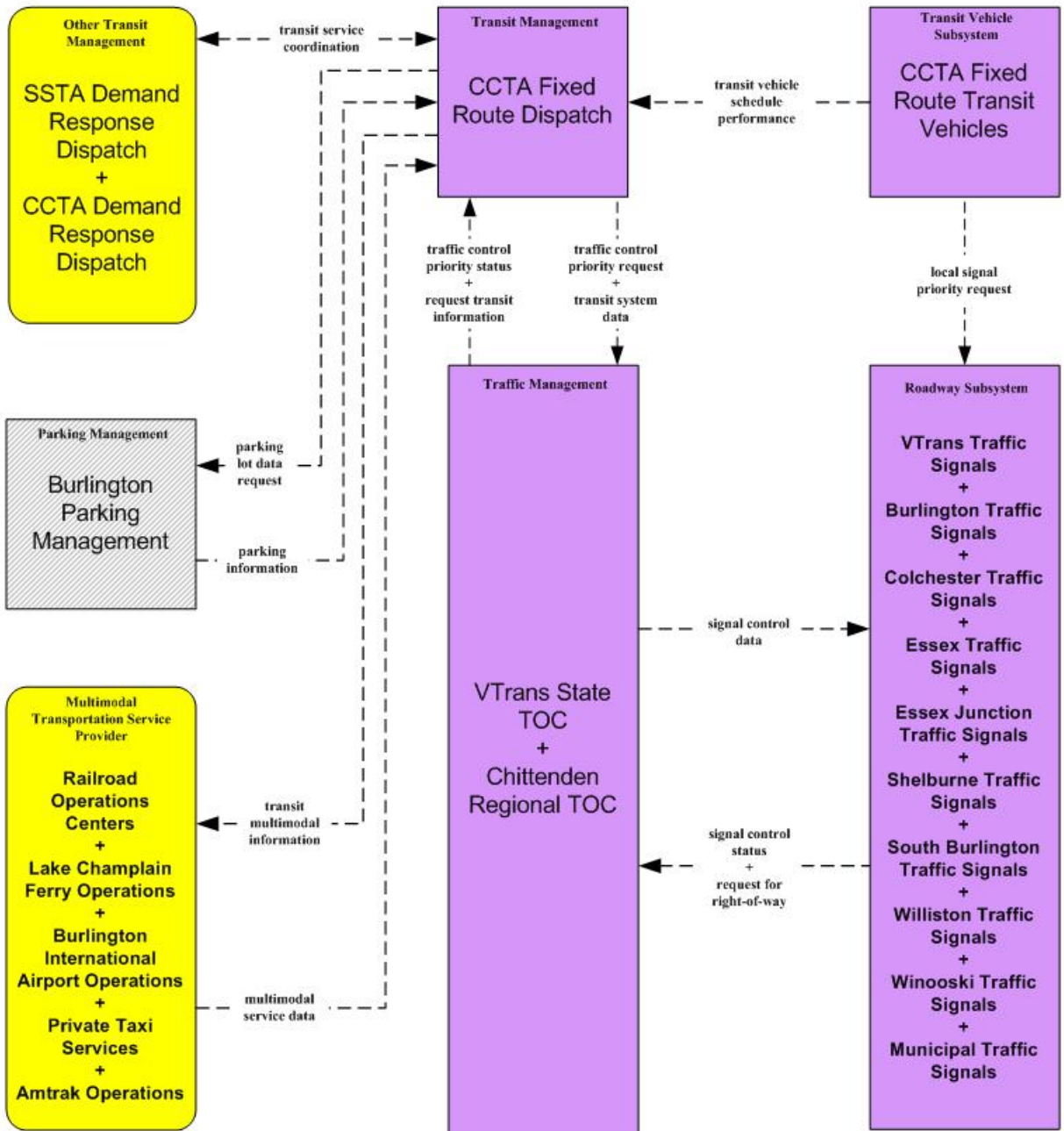

This market package instance is pending creation of the Chittenden Regional TOC. See the other APTS7 instance for details if it is not.

APTS7 – Multimodal Coordination
CCTA Fixed Route Dispatch

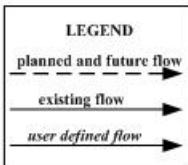
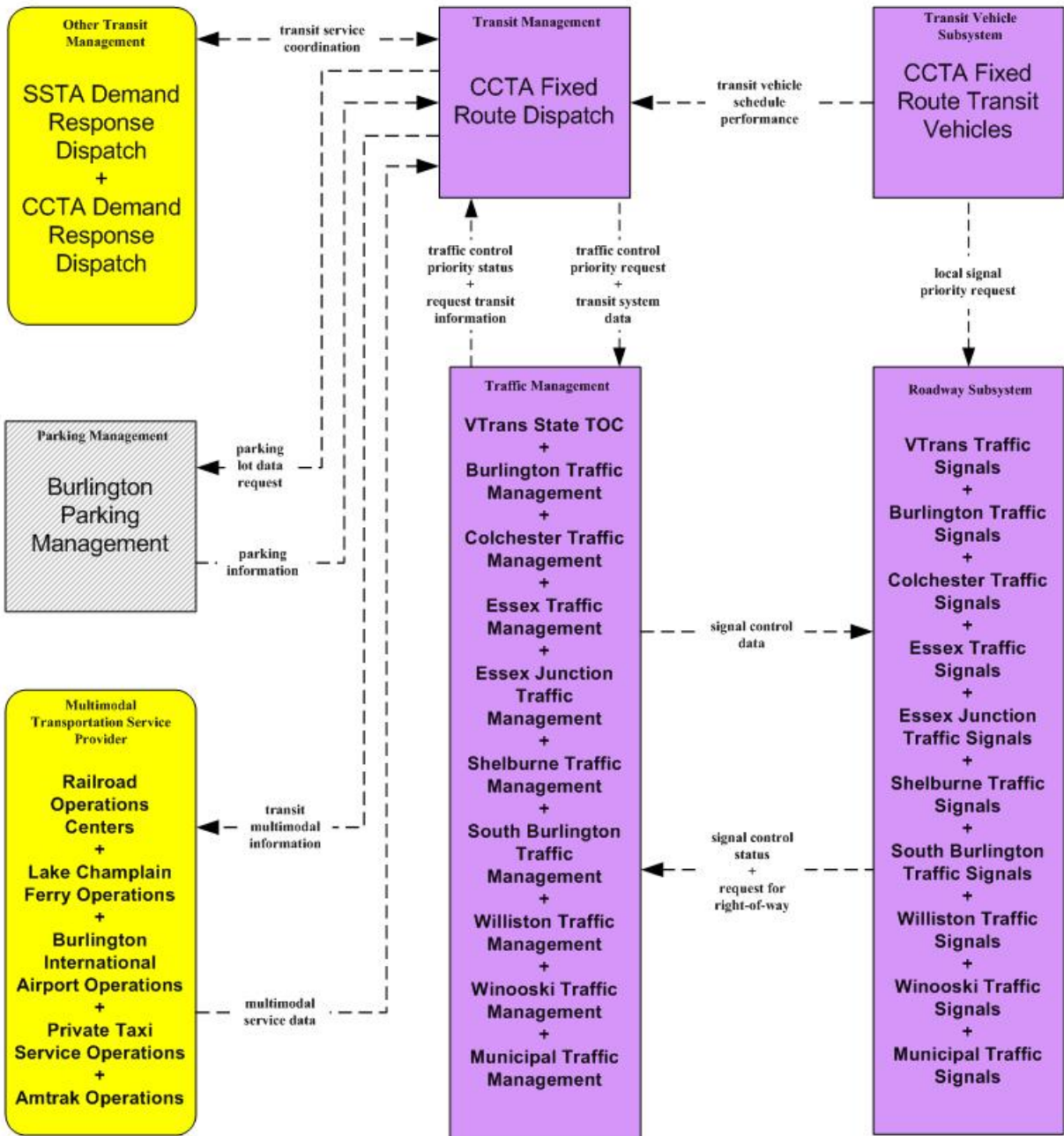

This market package instance is valid if the Chittenden Regional TOC is not created. See the APTS7 – Chittenden Regional TOC instance for details if it is.

ATIS1 - Broadcast Traveler Information CARS Information System

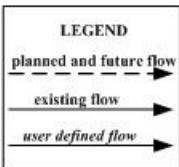
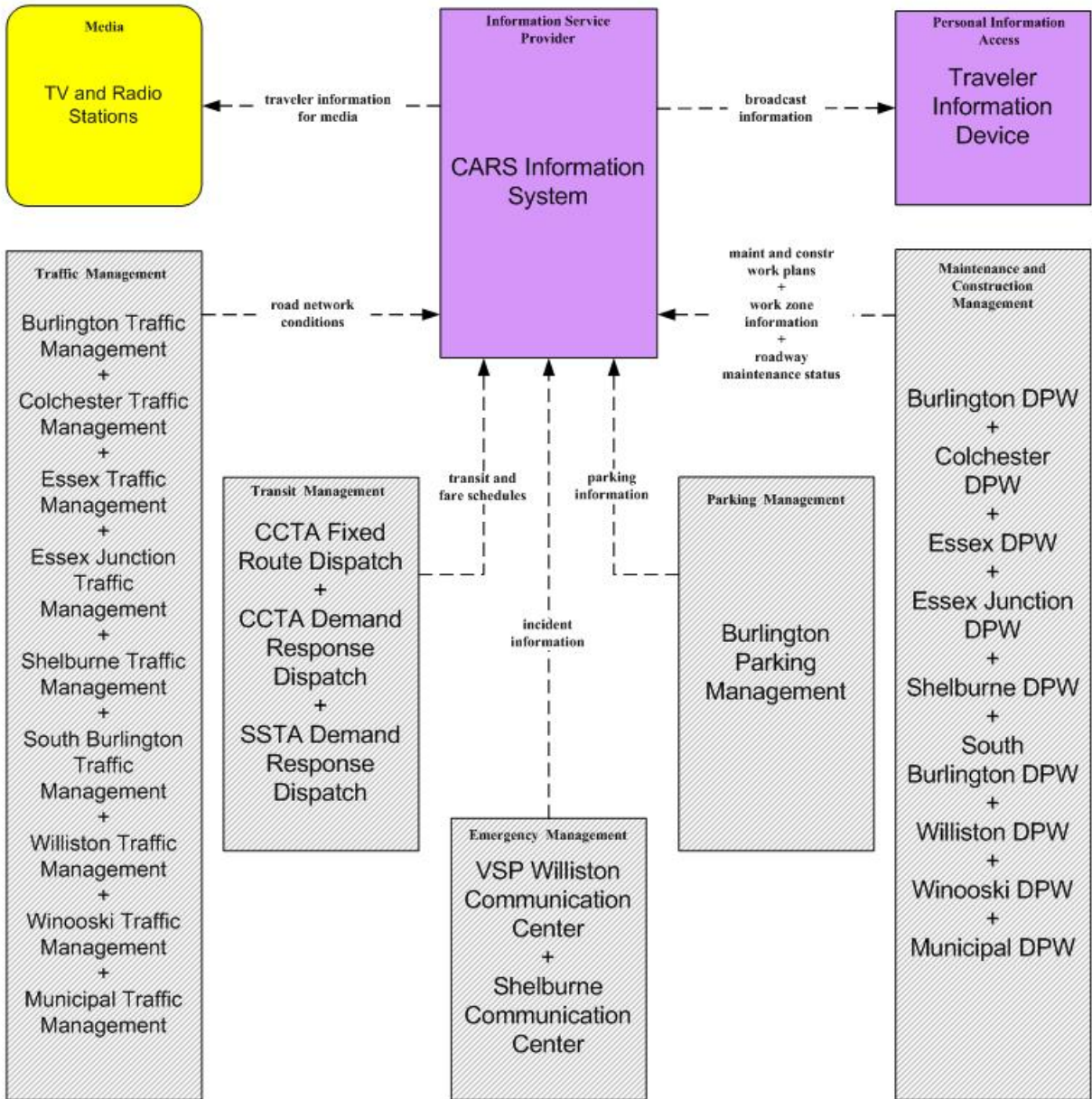

This market package instance is valid if the Chittenden Regional TOC is not created. See the ATIS1 – CARS – Chittenden Regional TOC instance for details if it is.

ATIS1 - Broadcast Traveler Information
 CARS Information System – Chittenden Regional TOC

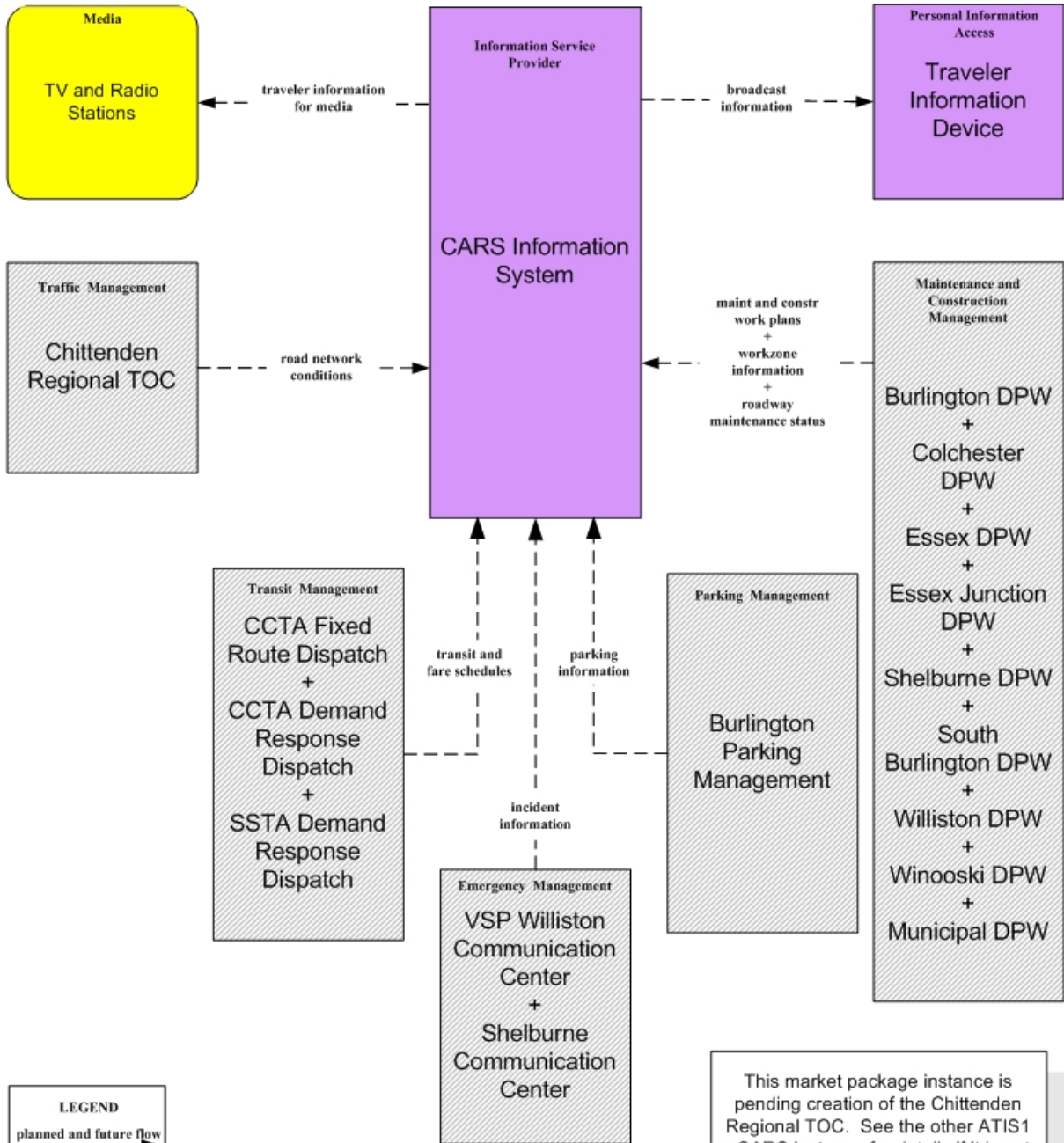

LEGEND

planned and future flow →

existing flow →

user defined flow →

This market package instance is pending creation of the Chittenden Regional TOC. See the other ATIS1 – CARS instance for details if it is not.

ATIS1 - Broadcast Traveler Information South Burlington Website

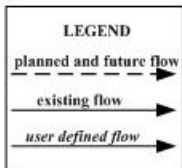
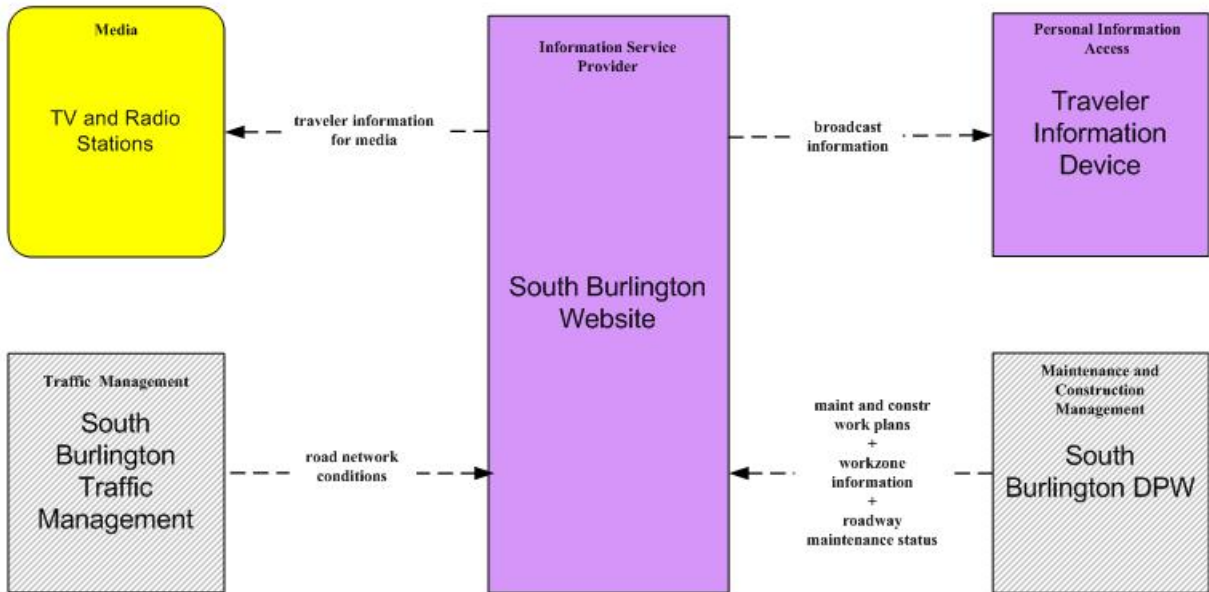

ATMS01 - Network Surveillance South Burlington Traffic Management

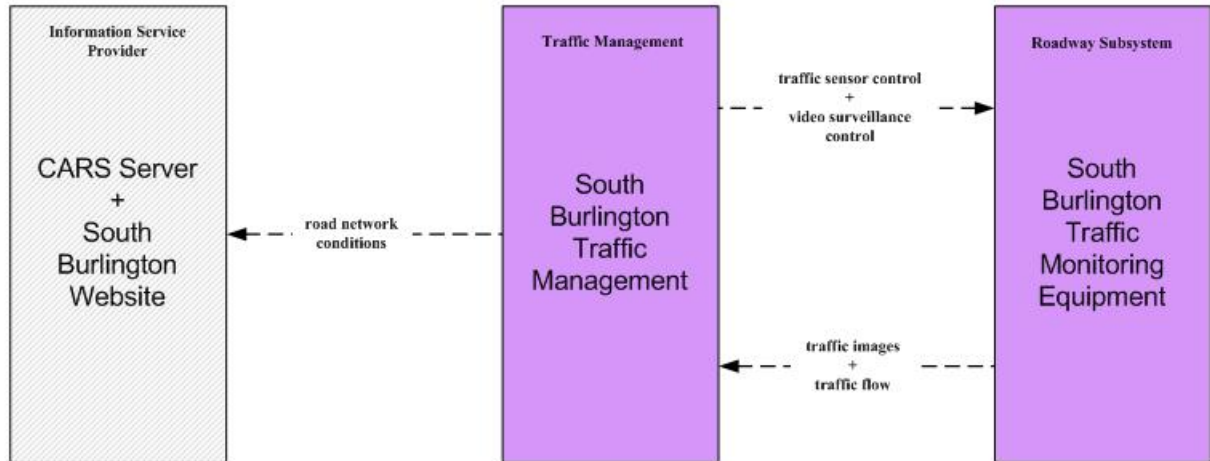

LEGEND

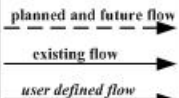

ATMS03 - Surface Street Control
South Burlington Traffic Management

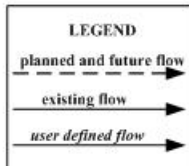
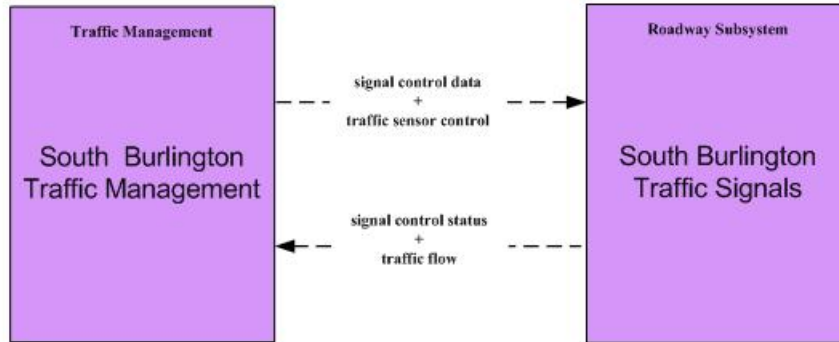

ATMS06 – Traffic Information Dissemination
Chittenden Regional TOC (Future)

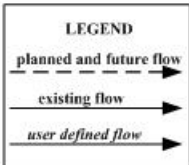
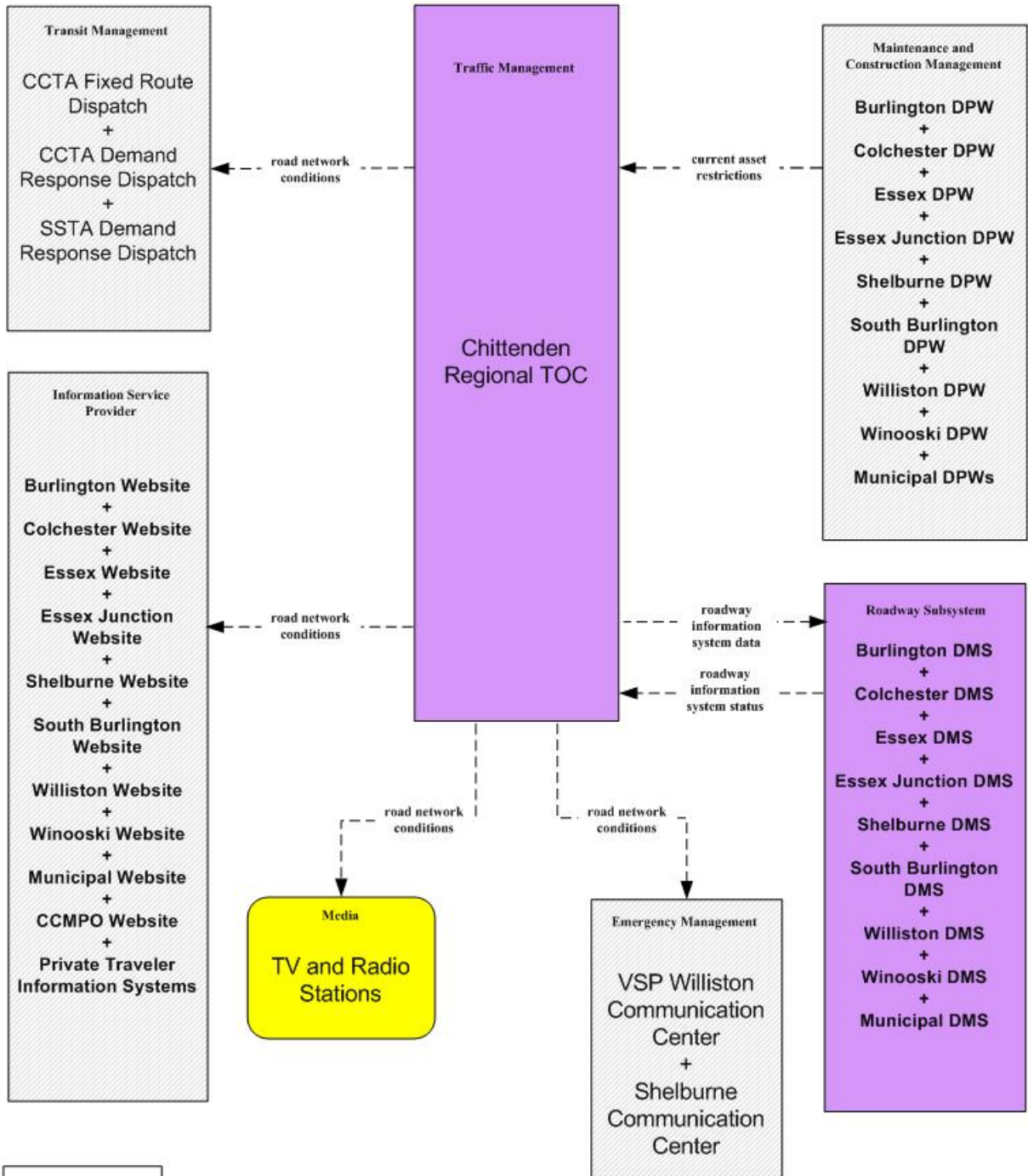

ATMS06 – Traffic Information Dissemination South Burlington Traffic Management

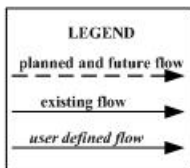
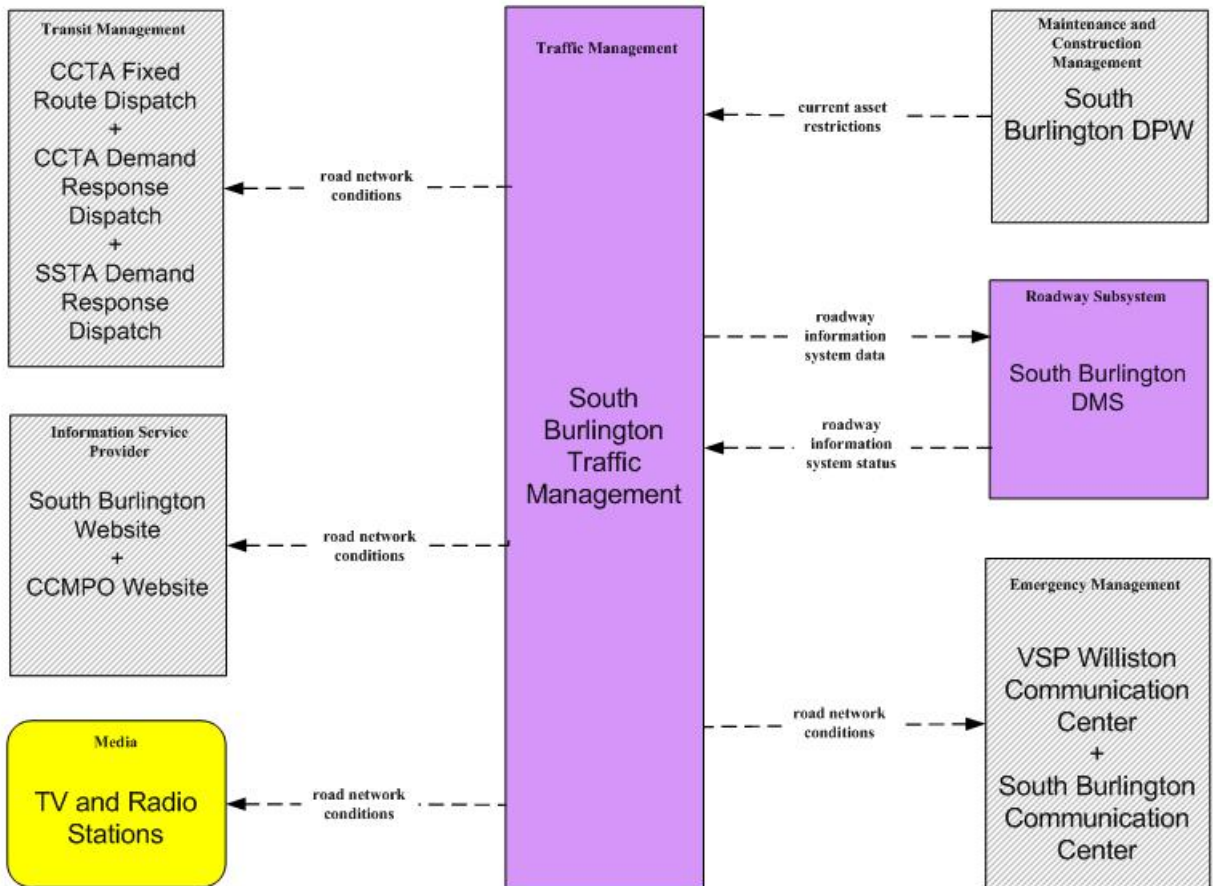

ATMS07 – Regional Traffic Control
Chittenden Regional TOC

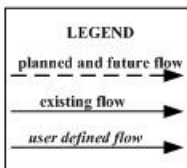
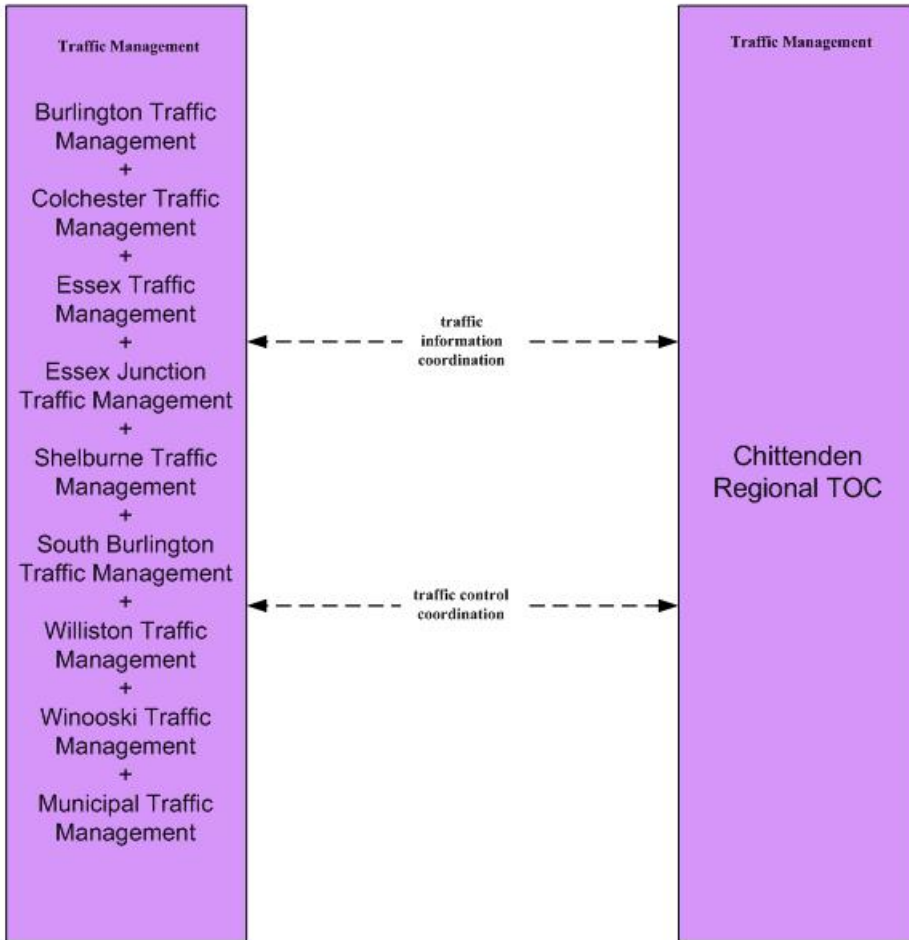

ATMS08 – Incident Management
Chittenden Regional TOC

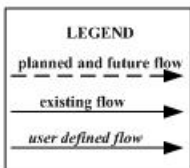
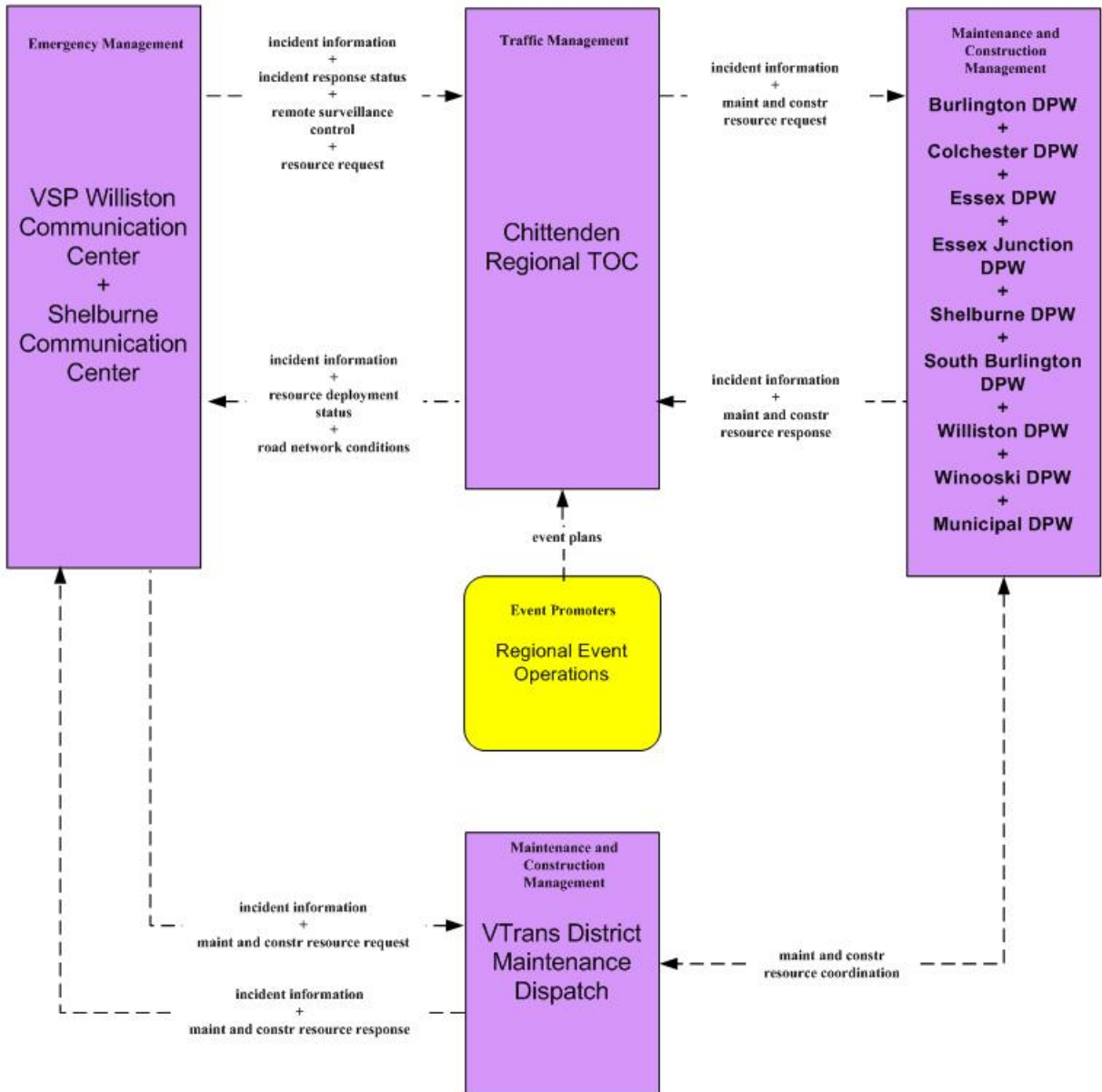

ATMS08 – Incident Management South Burlington Traffic Management

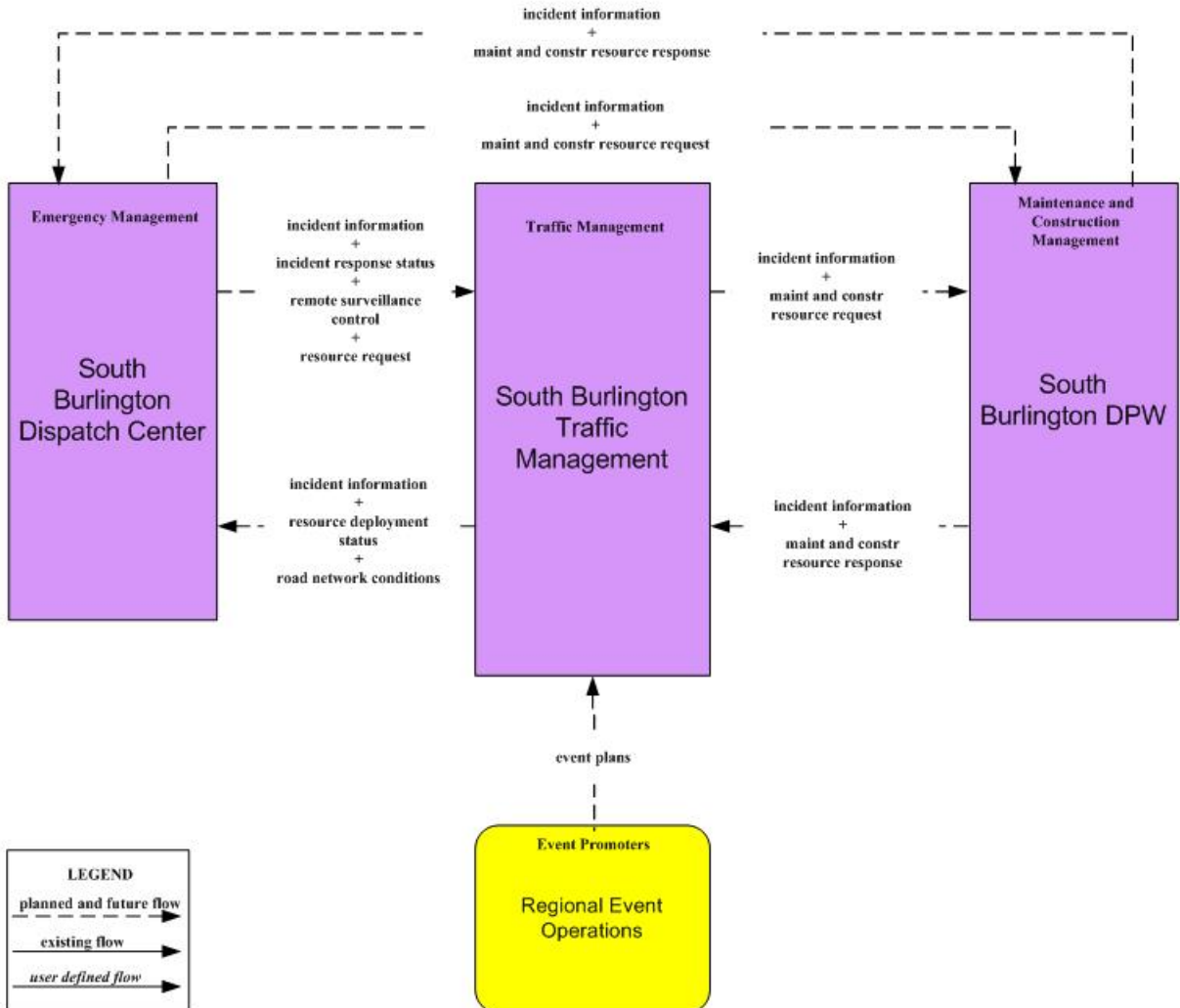

**ATMS13 - Standard Railroad Grade Crossing
Chittenden Regional Traffic Operations Center (Future)**

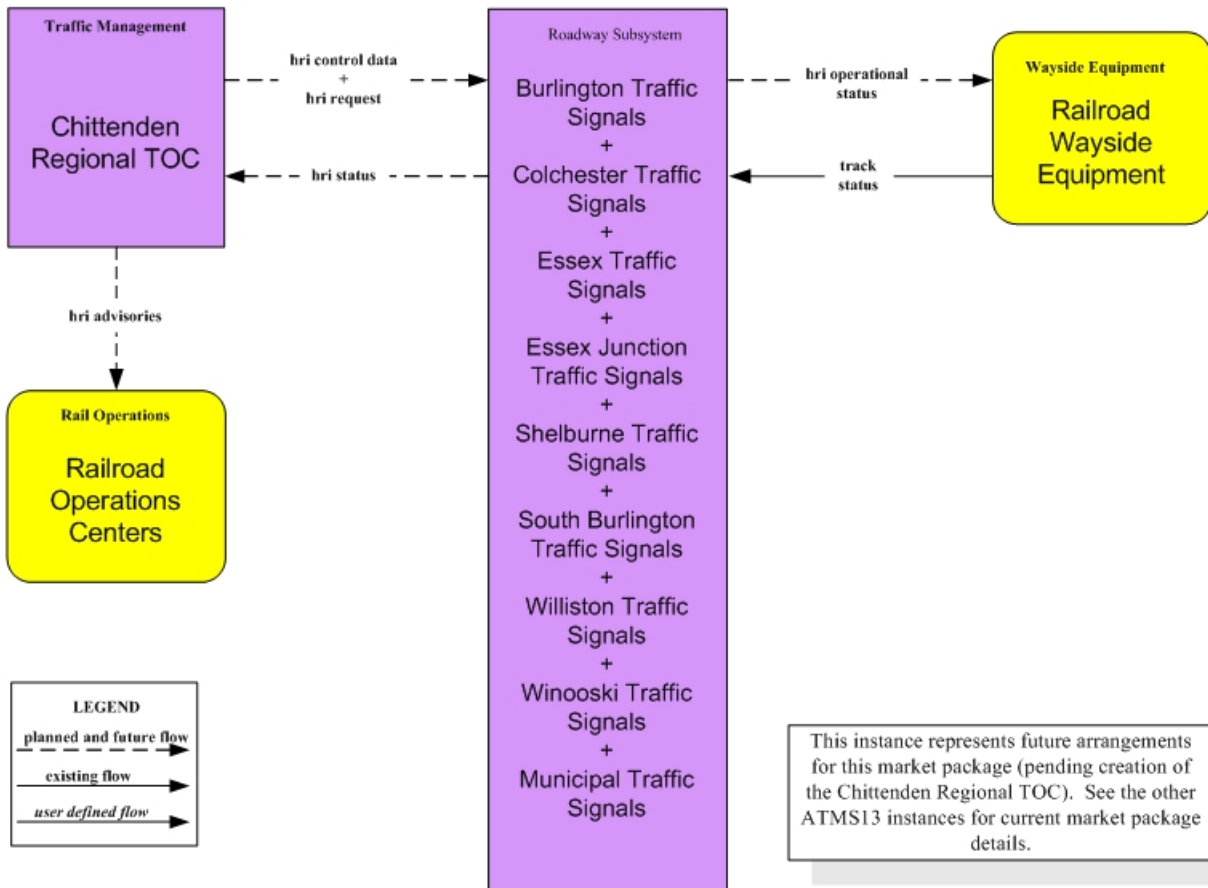

ATMS13 - Standard Railroad Grade Crossing
South Burlington Traffic Management

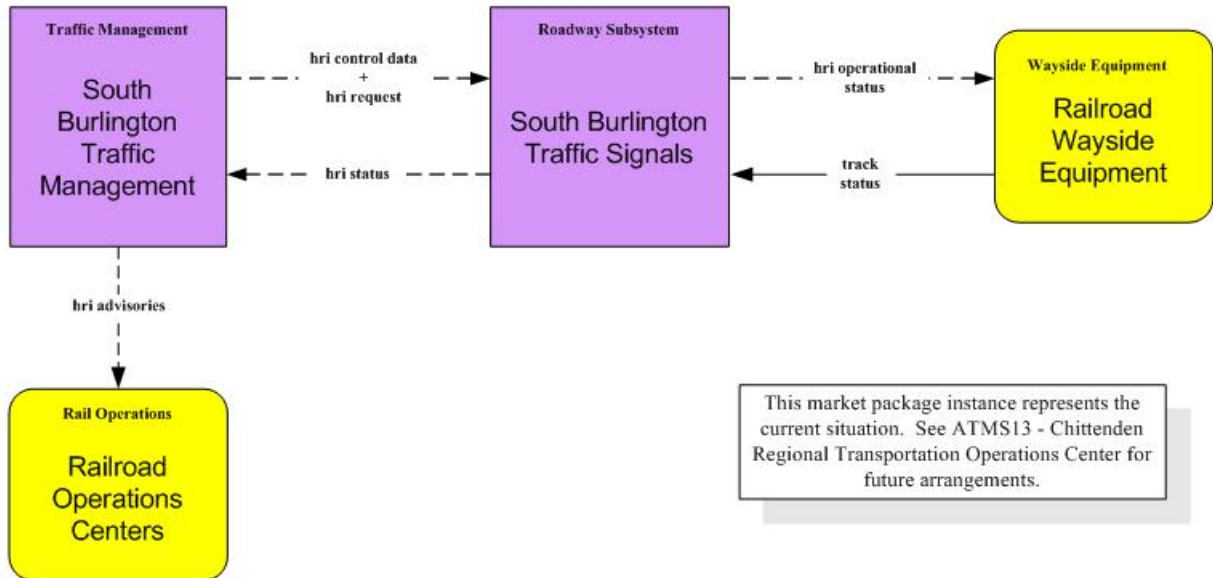

This market package instance represents the current situation. See ATMS13 - Chittenden Regional Transportation Operations Center for future arrangements.

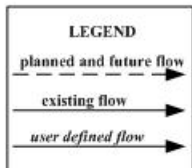

ATMS15 – Railroad Operations Coordination

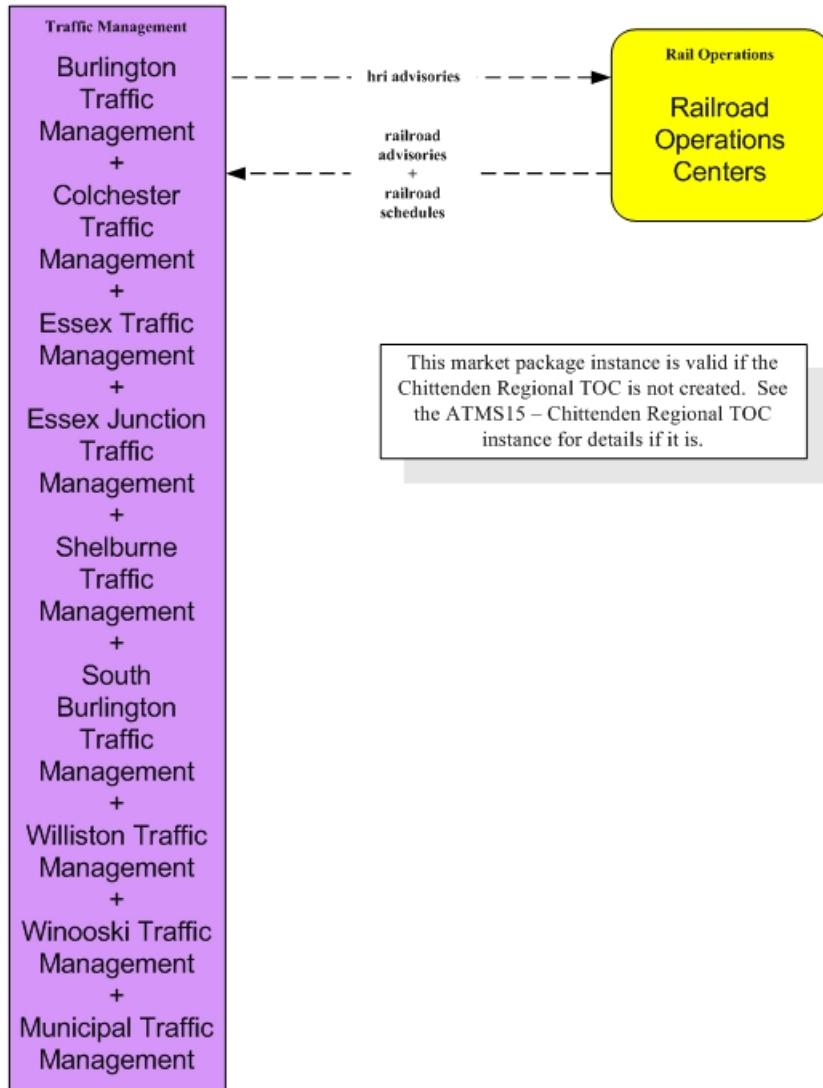

This market package instance is valid if the Chittenden Regional TOC is not created. See the ATMS15 – Chittenden Regional TOC instance for details if it is.

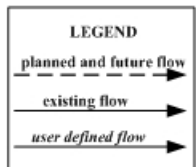

EMO2 – Emergency Routing
1 of 2 - Chittenden Regional TOC

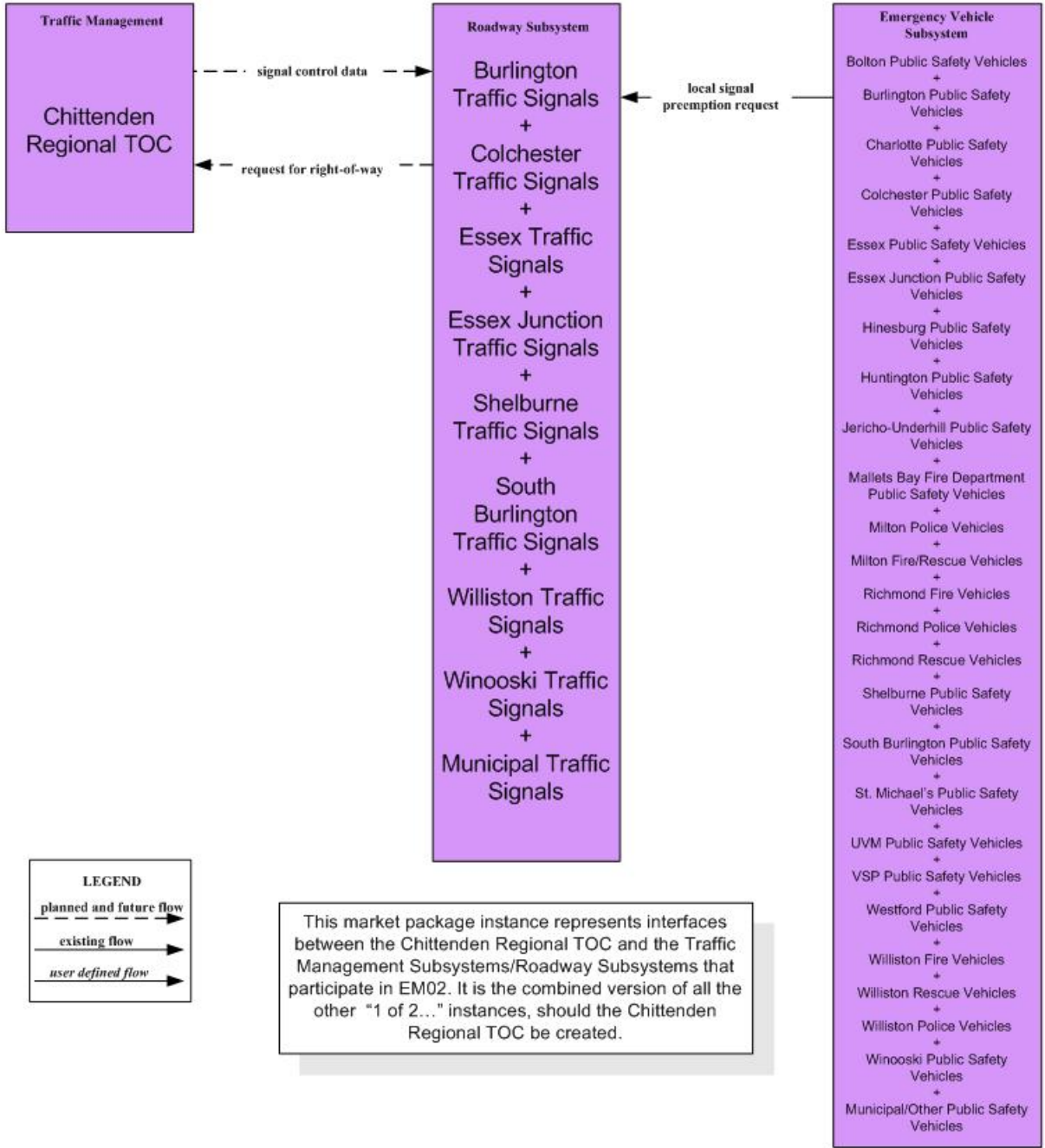

EMO2 – Emergency Routing

2 of 2 – Emergency Management

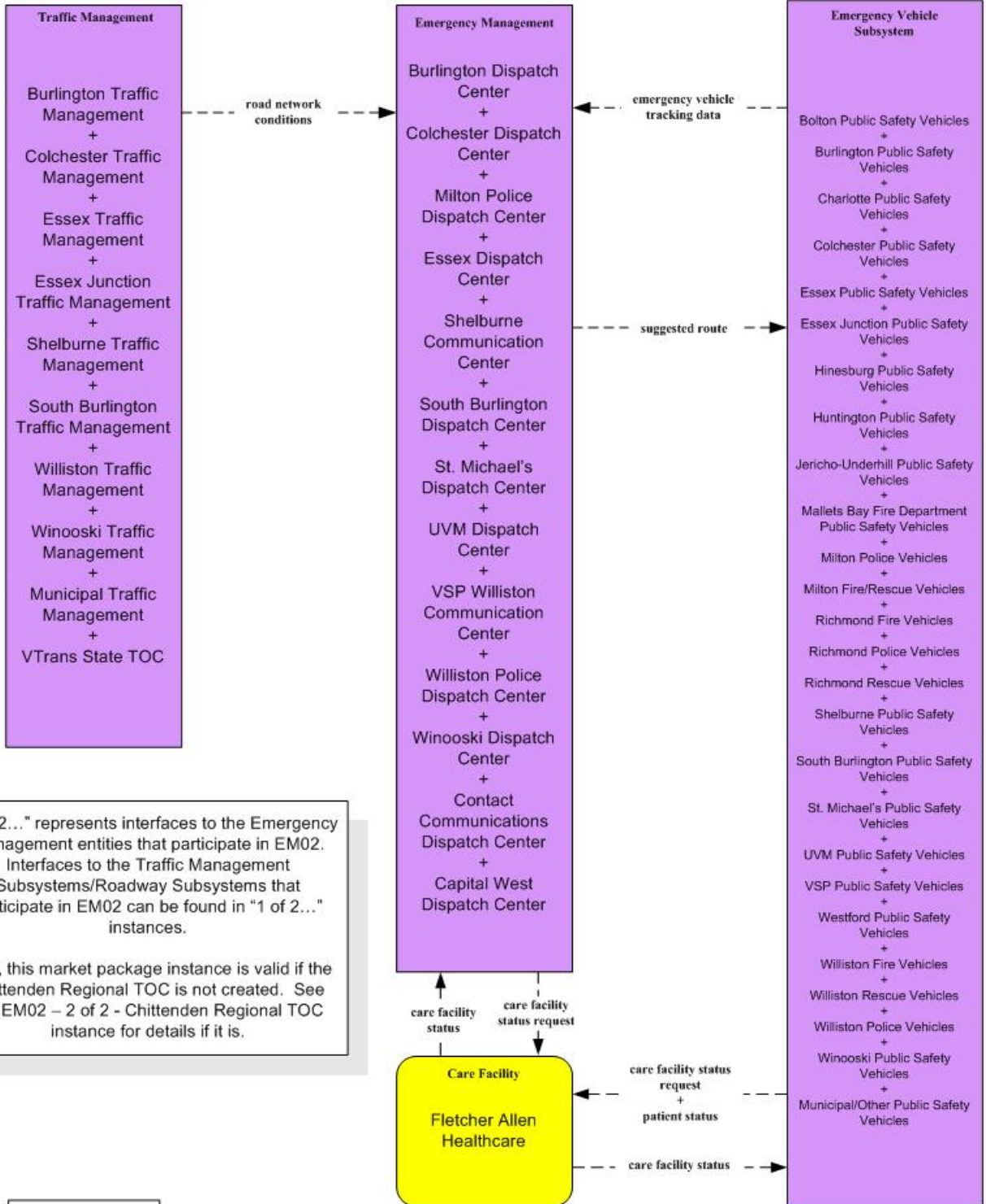

"2 of 2..." represents interfaces to the Emergency Management entities that participate in EM02. Interfaces to the Traffic Management Subsystems/Roadway Subsystems that participate in EM02 can be found in "1 of 2..." instances.

Also, this market package instance is valid if the Chittenden Regional TOC is not created. See the EM02 – 2 of 2 - Chittenden Regional TOC instance for details if it is.

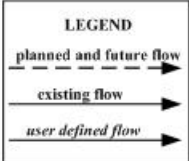

EMO2 – Emergency Routing 1 of 2 - South Burlington

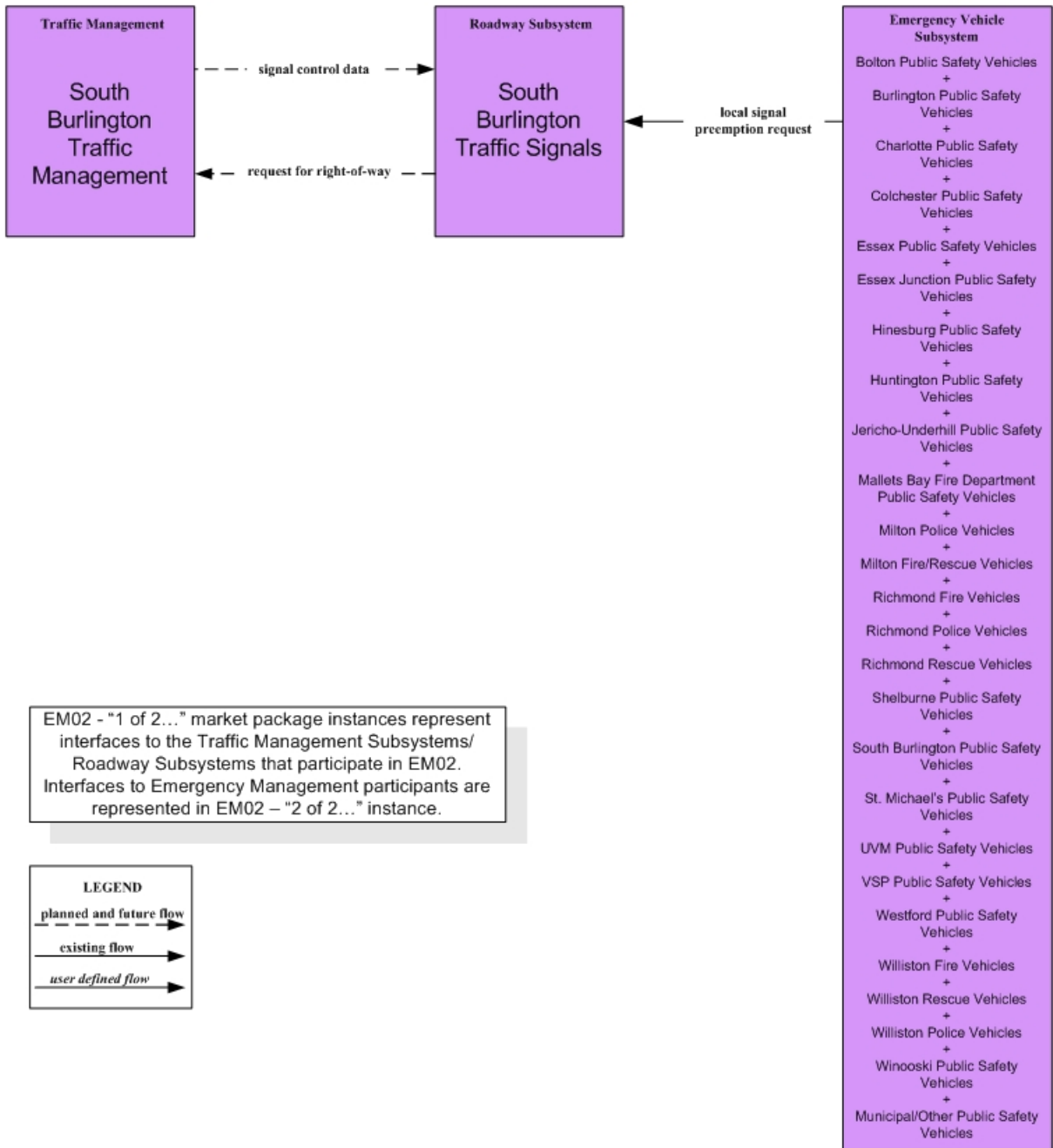

**EMO6 – Wide Area Alert
Vermont Statewide EOC & VSP Headquarters**

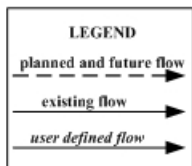
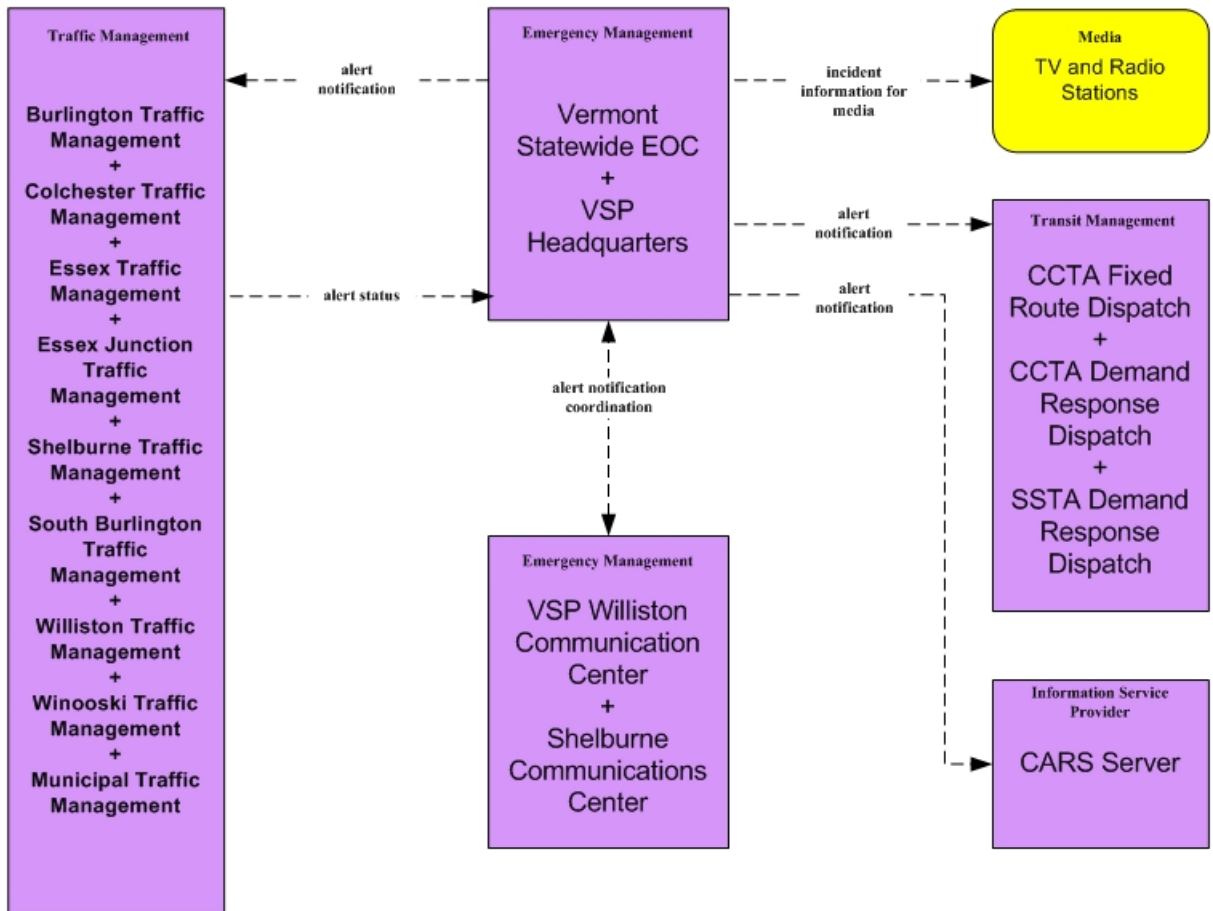

EM09 - Evacuation and Reentry Management
Vermont Statewide EOC

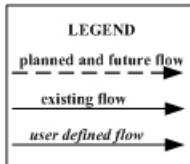
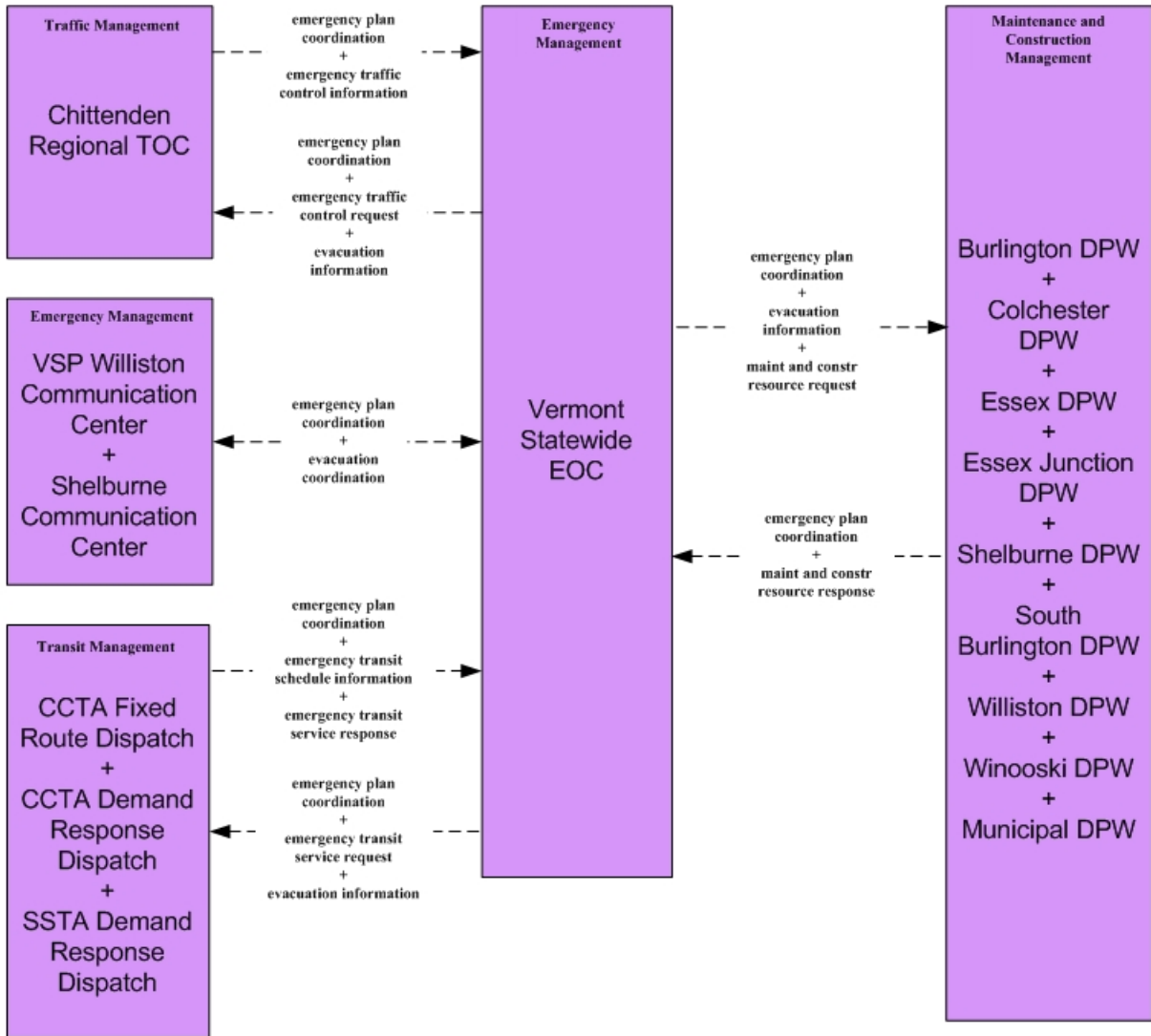

MC01 – Maintenance and Construction Vehicle Tracking
South Burlington DPW

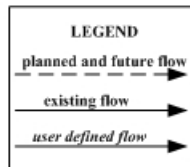
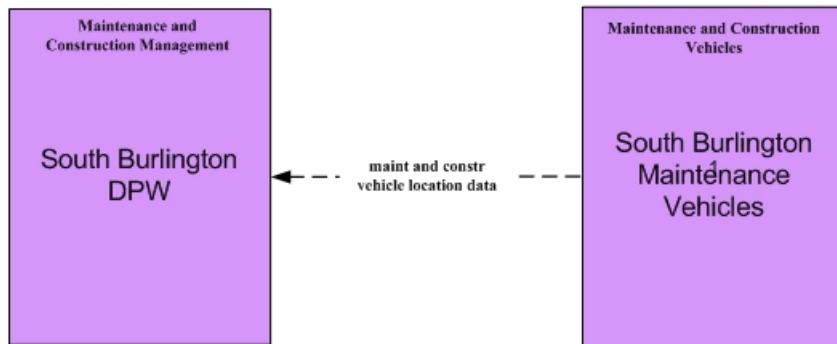

MC02 – Maintenance and Construction Vehicle Maintenance
South Burlington DPW

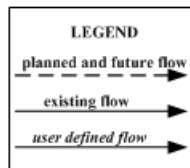
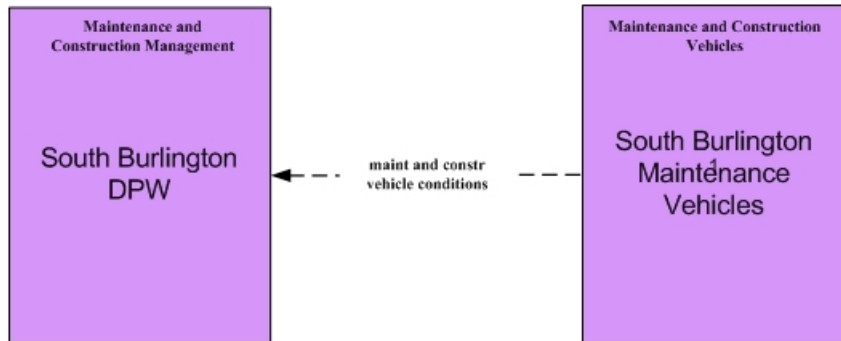

MC04 - Weather Information Processing and Distribution
Weather Services

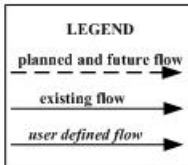
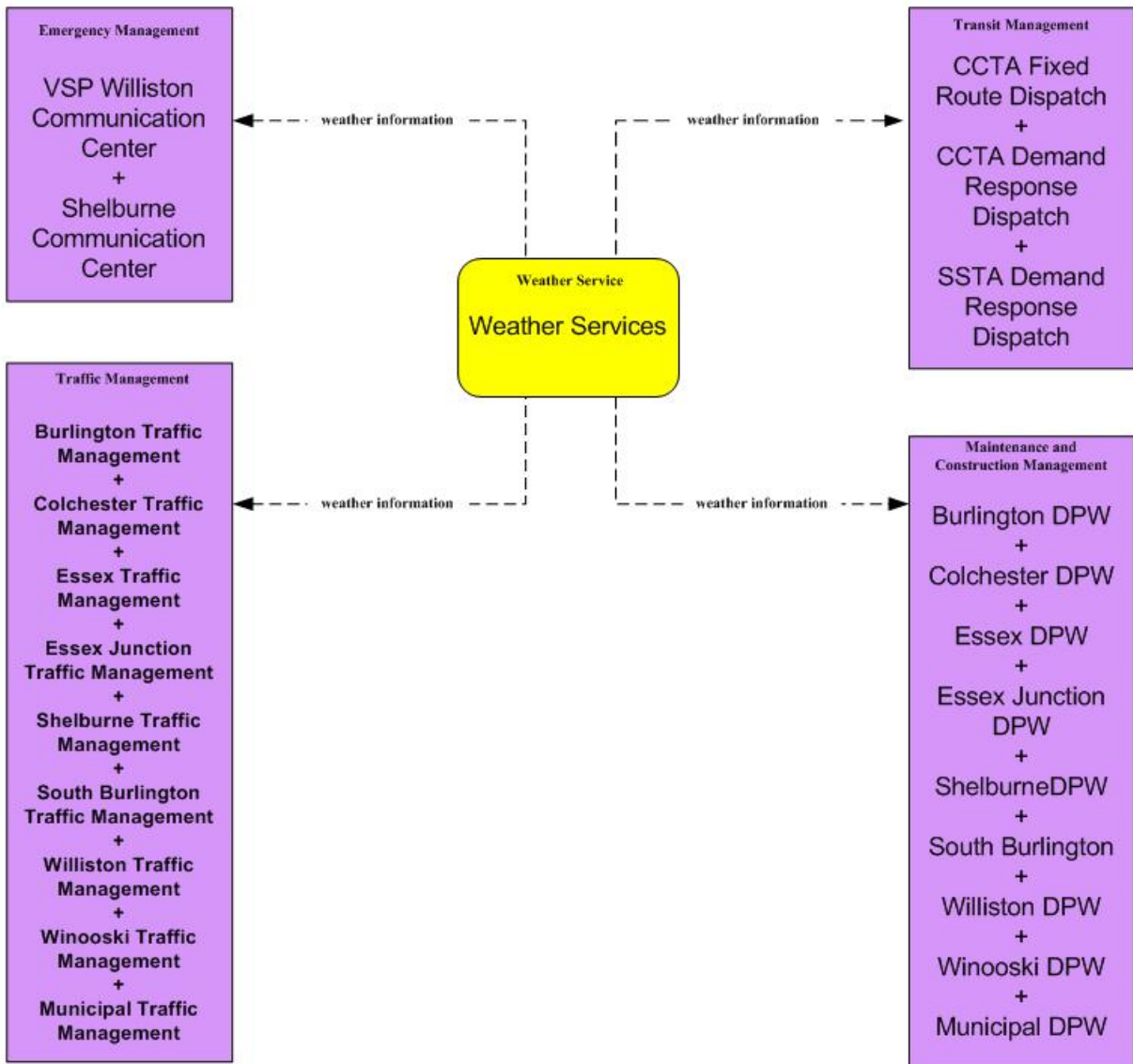

This instance represents the situation for this market package with existing entities only. See the MC04 – Weather Services (Chittenden Regional TOC) instance for market package details pending creation of the Chittenden Regional TOC.

MC04 - Weather Information Processing and Distribution
Weather Services – Chittenden Regional TOC

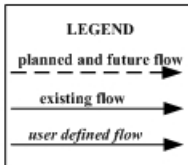
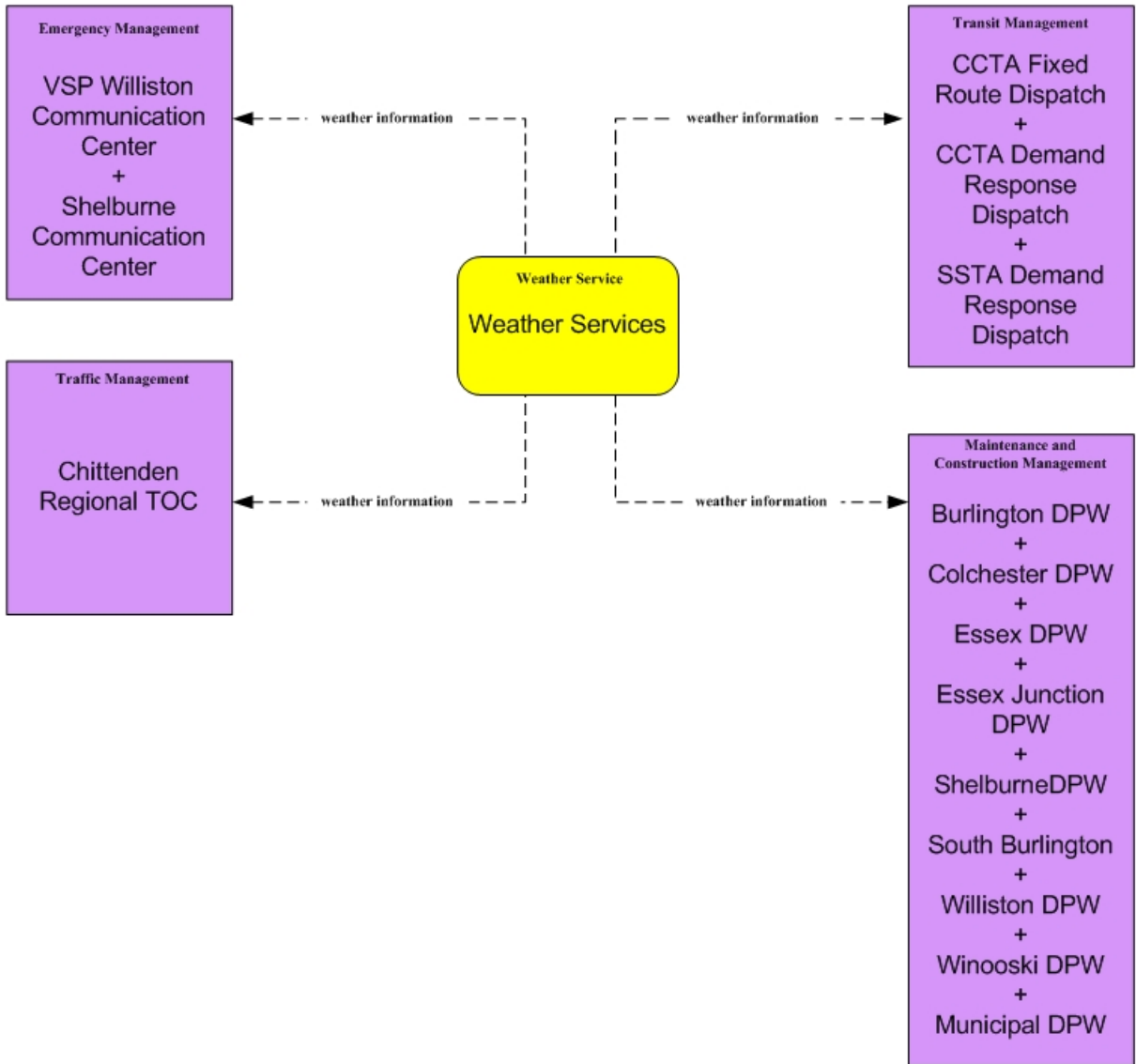

This instance represents the situation for this market package pending creation of the Chittenden Regional TOC. See the MC04 – Weather Services instance for market package details with existing entities only.

MC06 - Winter Maintenance
South Burlington DPW

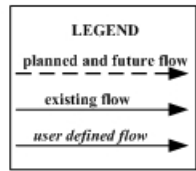
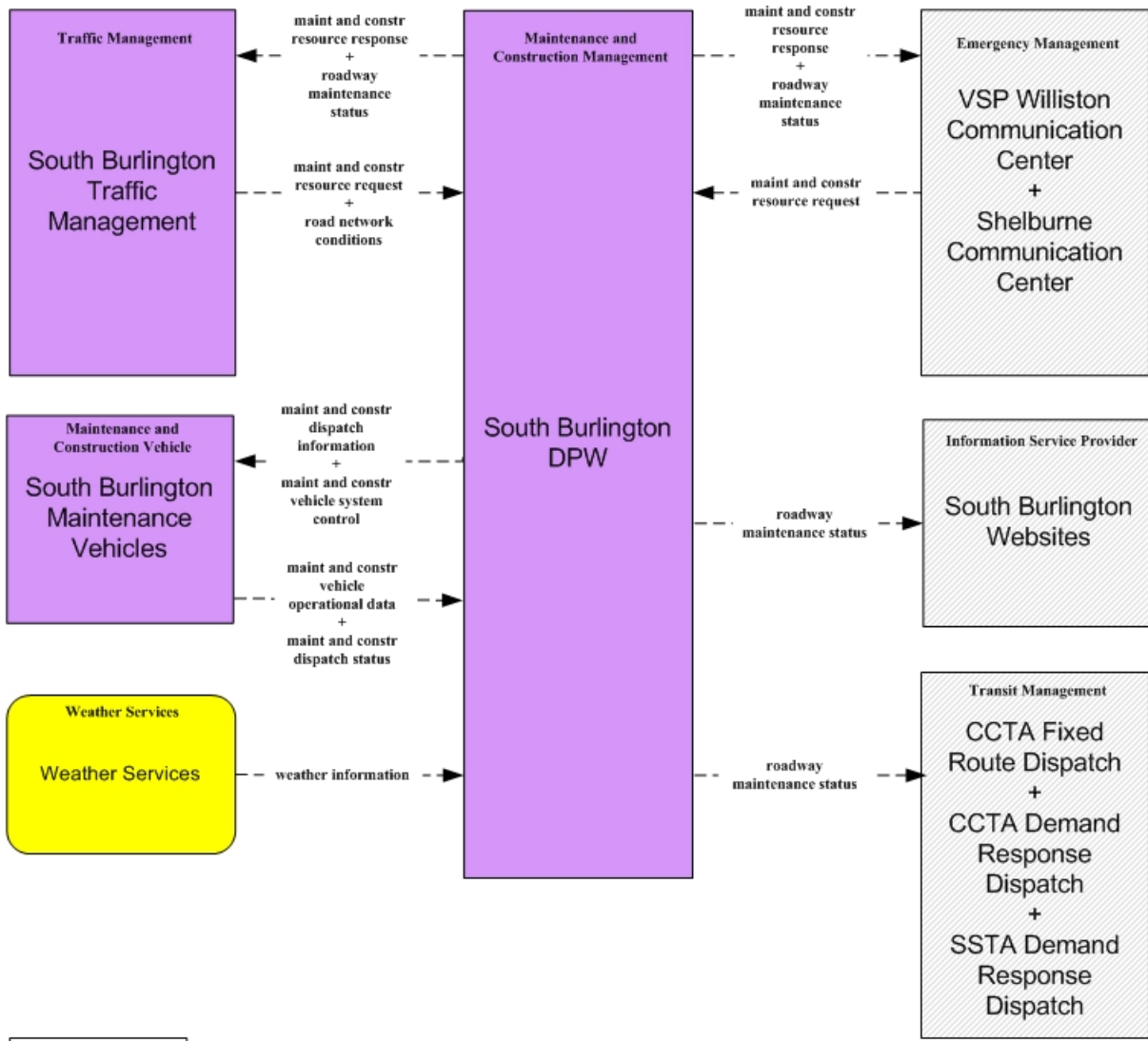

MC07 - Roadway Maintenance and Construction
South Burlington DPW

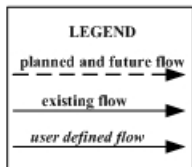
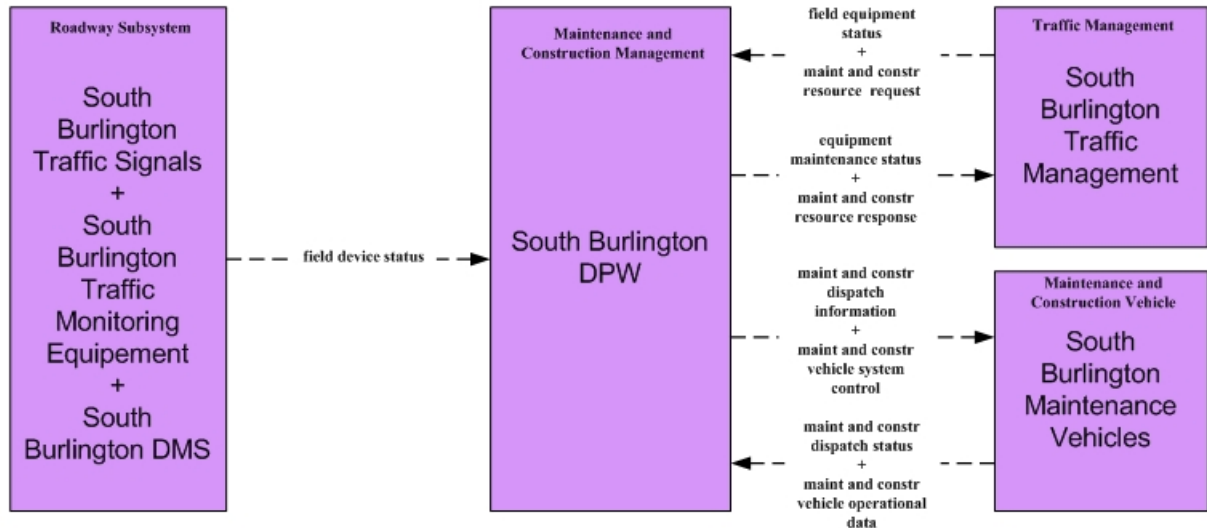

MC08 - Work Zone Management
South Burlington DPW

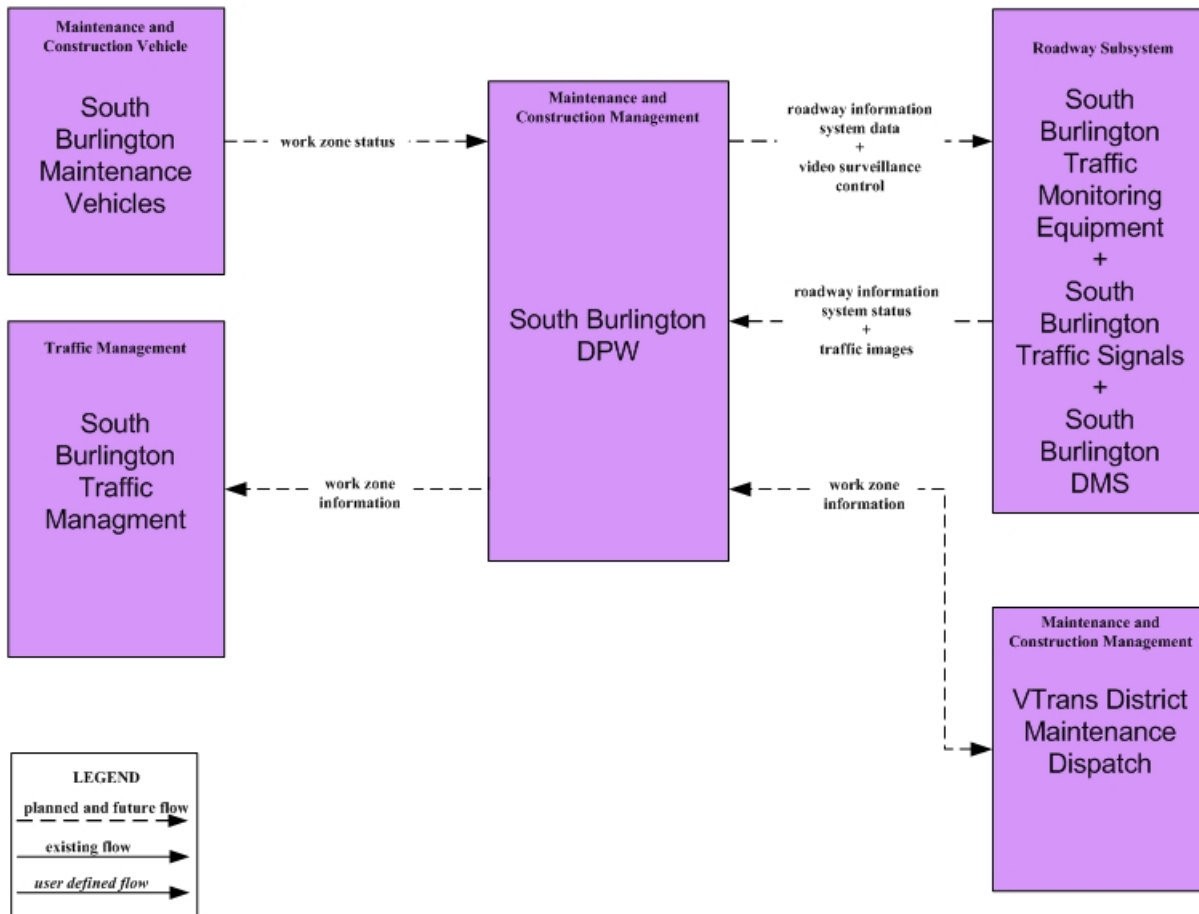

MC08 - Work Zone Management
VTrans District Maintenance Dispatch

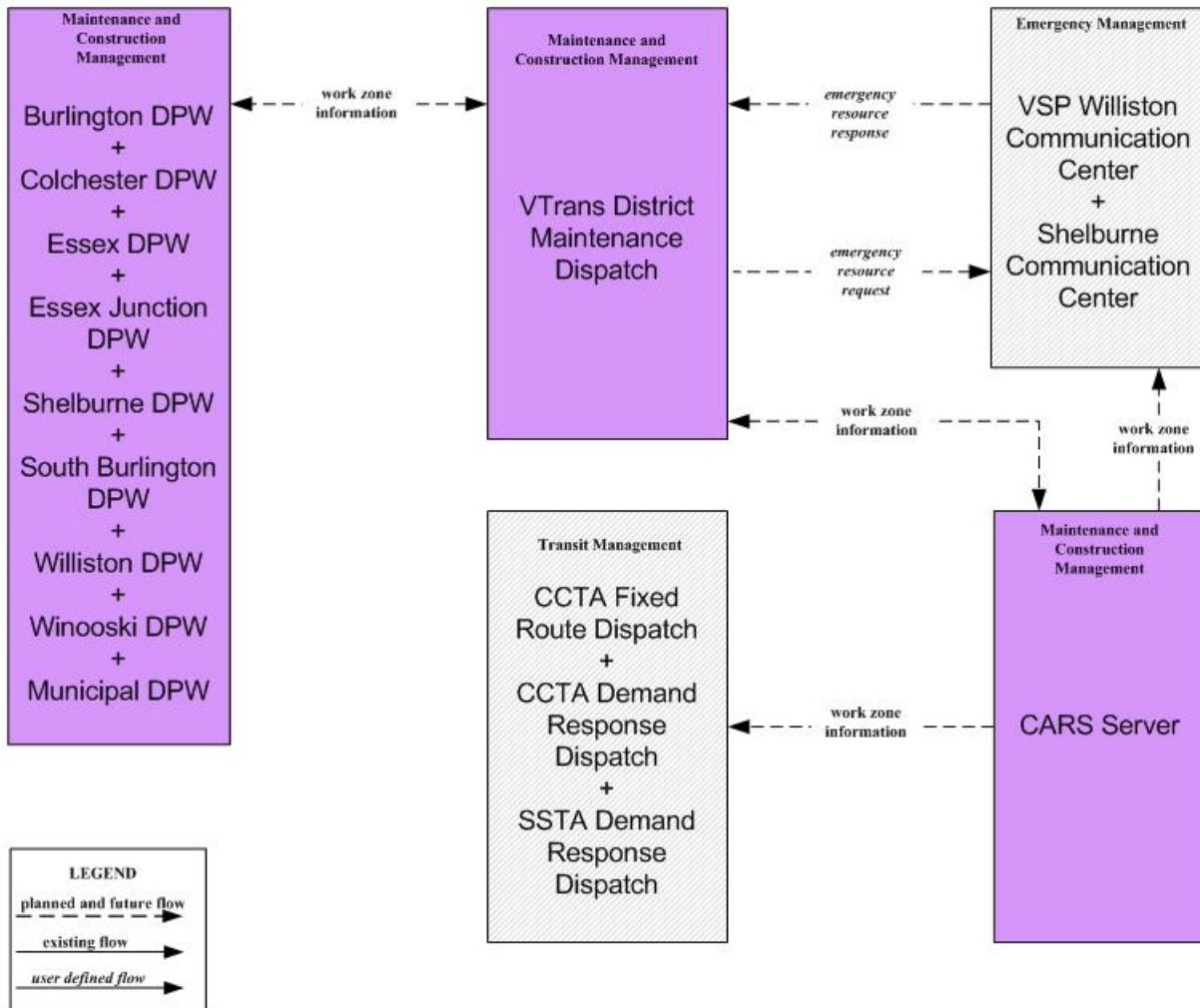

MC10 – Maintenance and Construction Activity Coordination
South Burlington DPW

