

AD1 - ITS Data Mart Colchester Data Repository

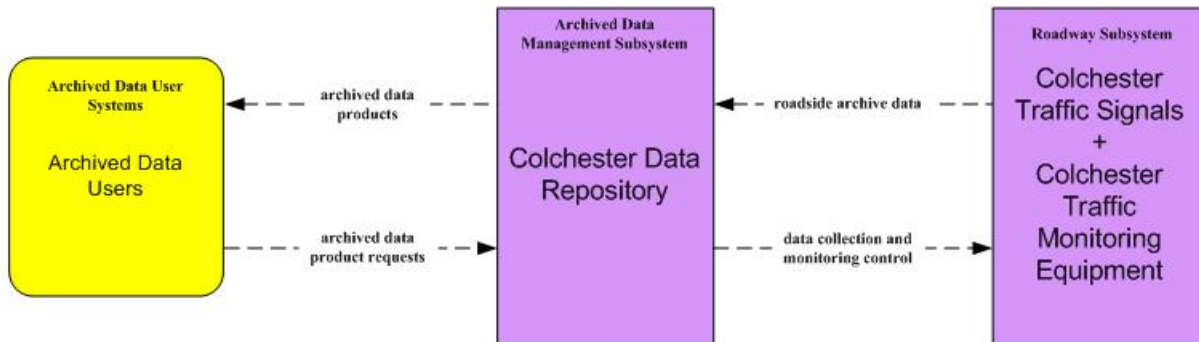

LEGEND

planned and future flow

existing flow

user defined flow

AD2 - ITS Data Warehouse
CCMPO Data Warehouse

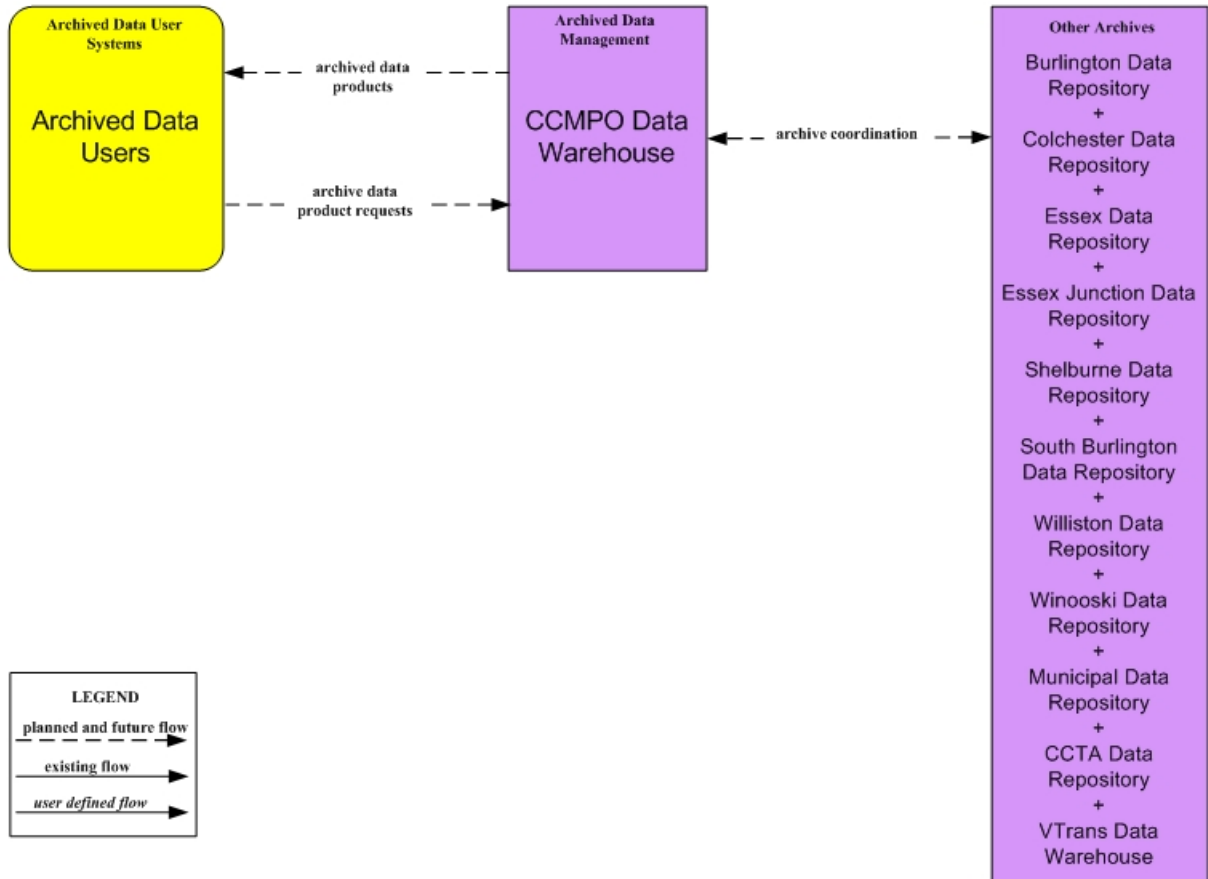

APTS7 – Multimodal Coordination
 CCTA Fixed Route Dispatch – Chittenden Regional TOC and VTrans State TOC

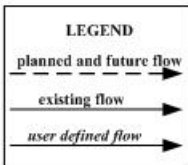
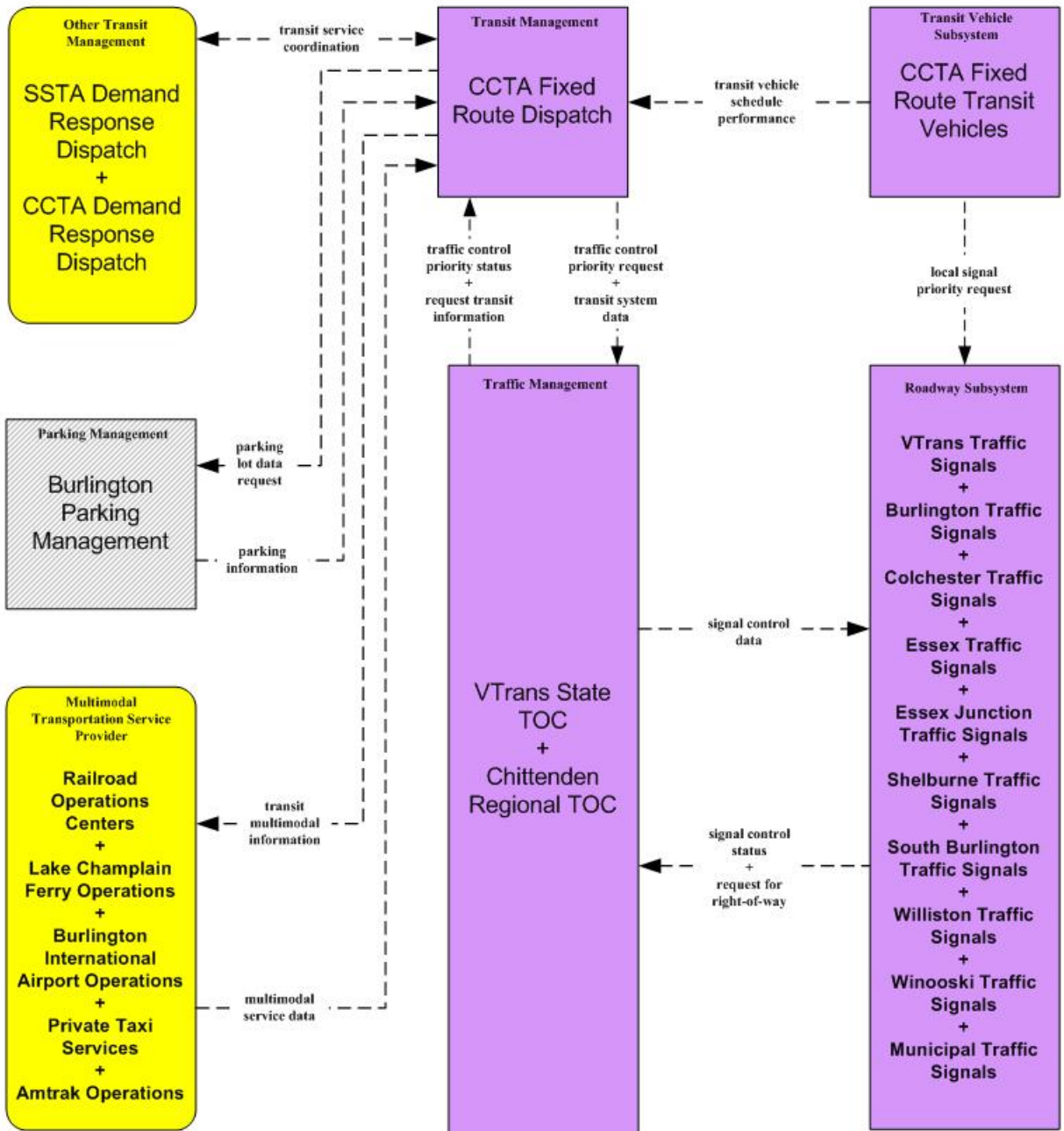

This market package instance is pending creation of the Chittenden Regional TOC. See the other APTS7 instance for details if it is not.

APTS7 – Multimodal Coordination
CCTA Fixed Route Dispatch

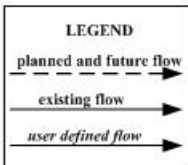
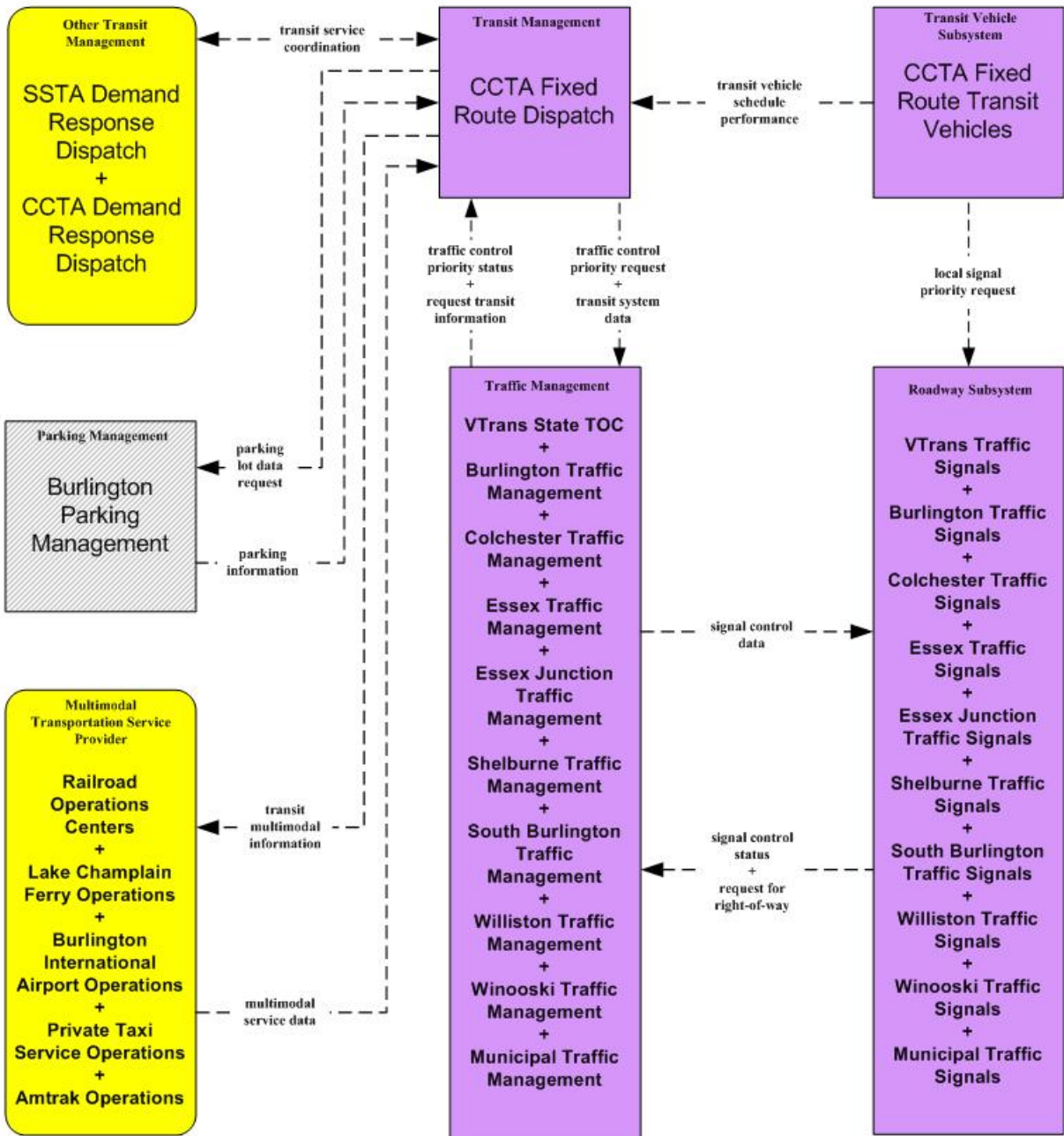

This market package instance is valid if the Chittenden Regional TOC is not created. See the APTS7 – Chittenden Regional TOC instance for details if it is.

ATIS1 - Broadcast Traveler Information CARS Information System

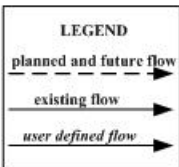
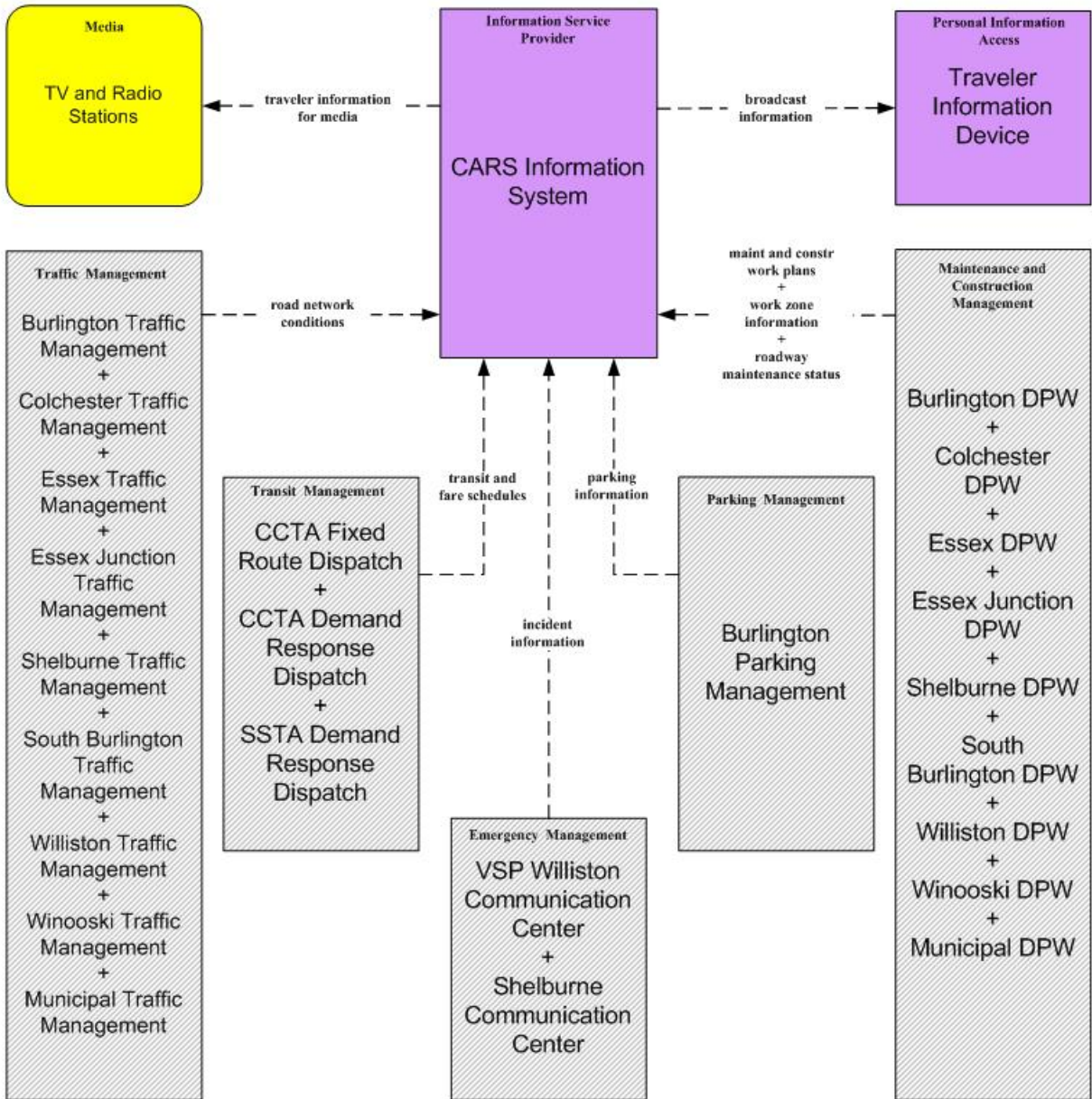

This market package instance is valid if the Chittenden Regional TOC is not created. See the ATIS1 – CARS – Chittenden Regional TOC instance for details if it is.

ATIS1 - Broadcast Traveler Information
 CARS Information System – Chittenden Regional TOC

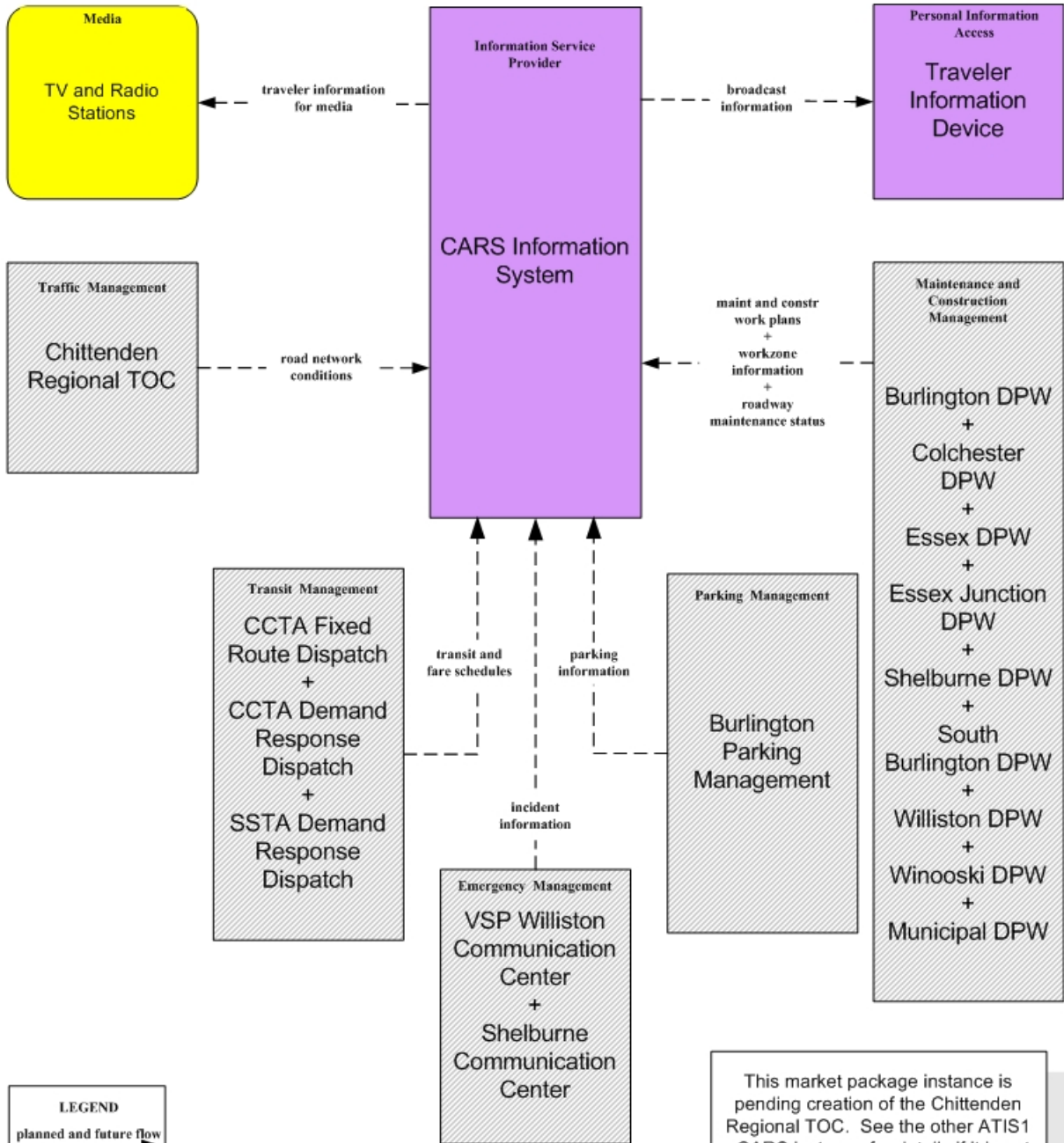

LEGEND
 planned and future flow
 existing flow
 user defined flow

This market package instance is pending creation of the Chittenden Regional TOC. See the other ATIS1 - CARS instance for details if it is not.

ATIS1 - Broadcast Traveler Information Colchester Website

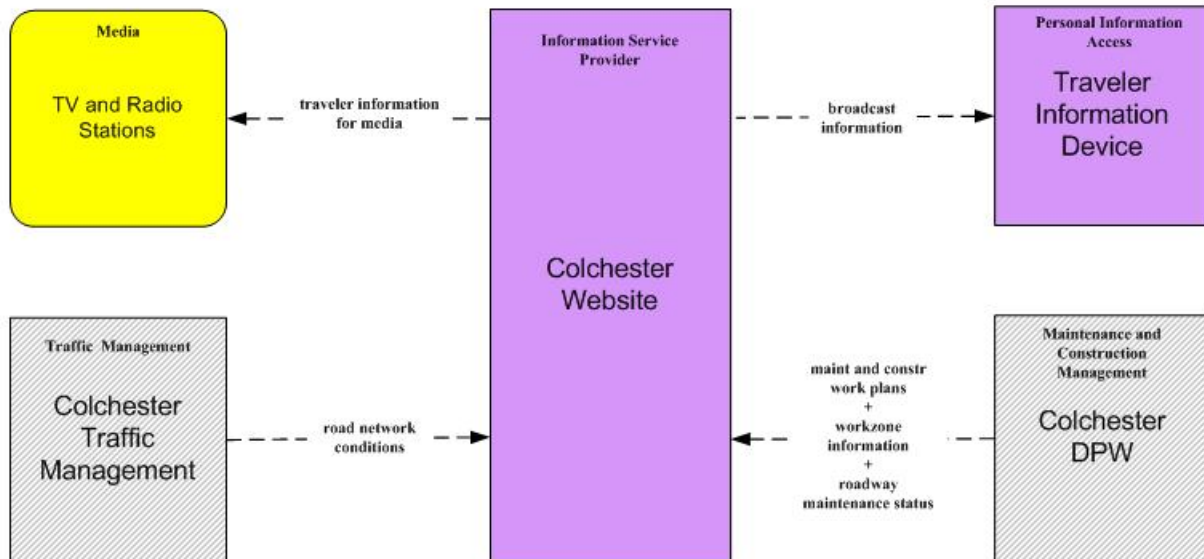

LEGEND

planned and future flow →

existing flow →

user defined flow →

ATMS01 - Network Surveillance Colchester Traffic Management

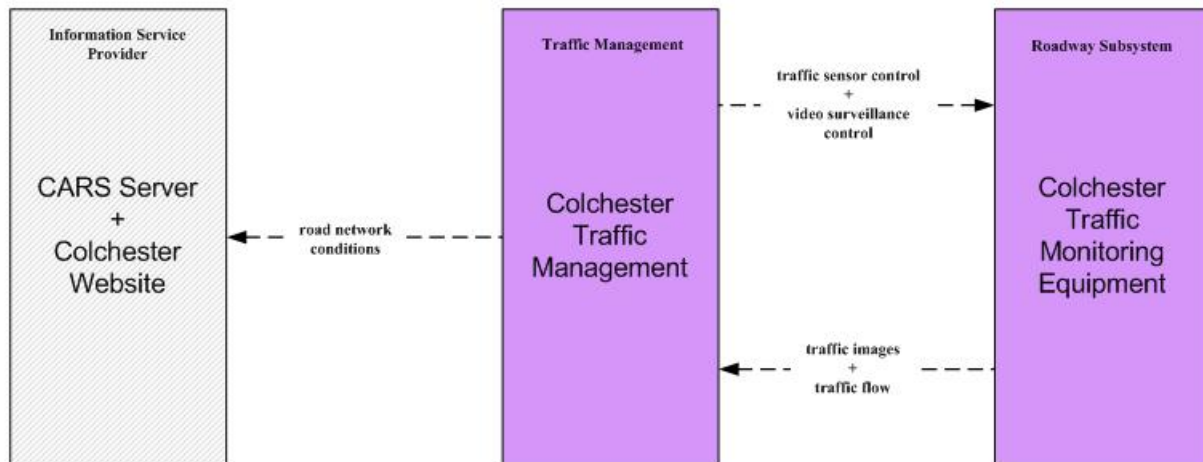

LEGEND

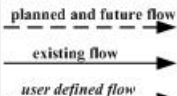

ATMS03 - Surface Street Control
Colchester Traffic Management

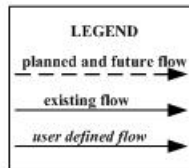
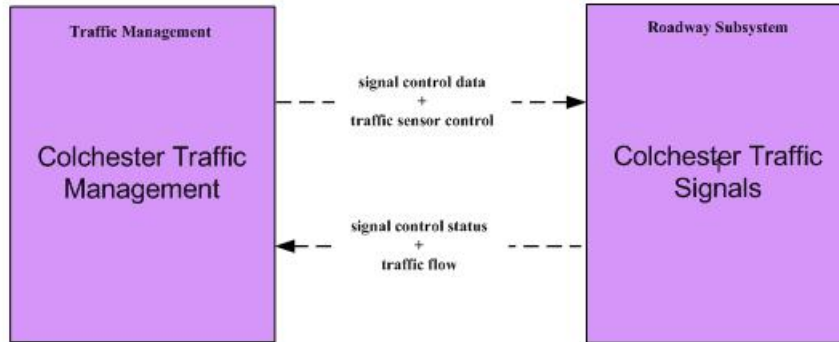

ATMS06 – Traffic Information Dissemination Colchester Traffic Management

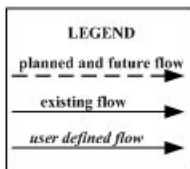
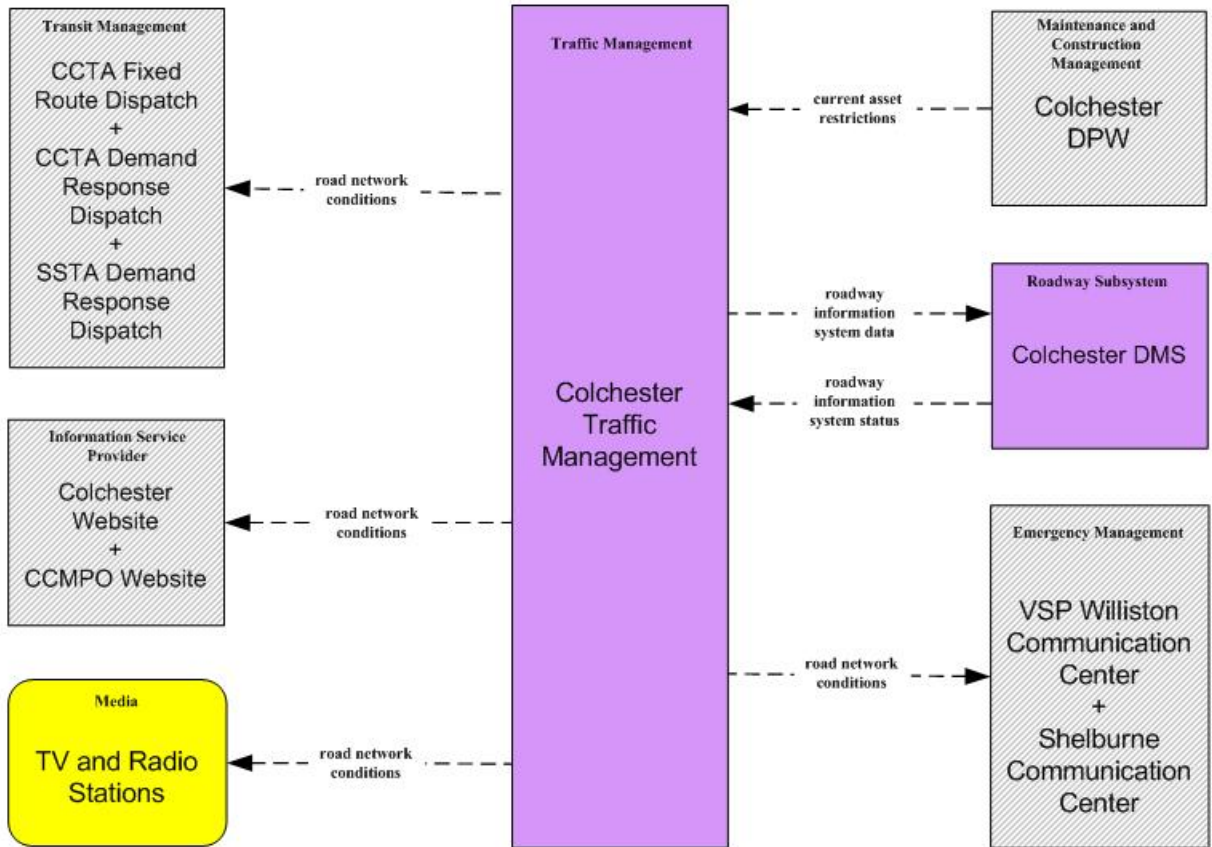

ATMS06 – Traffic Information Dissemination Chittenden Regional TOC (Future)

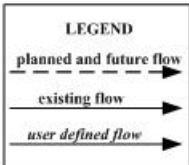
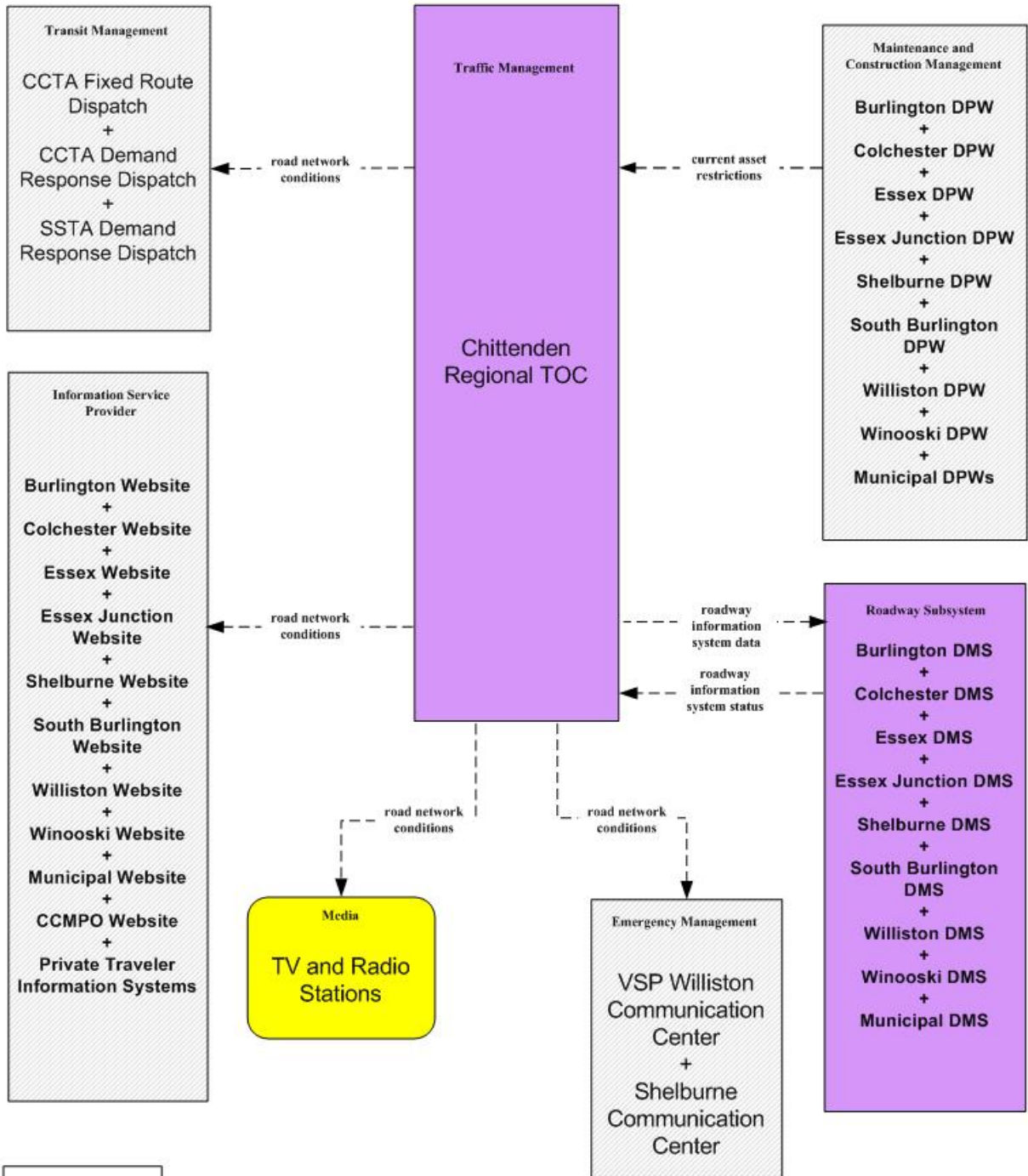

ATMS07 – Regional Traffic Control
Chittenden Regional TOC

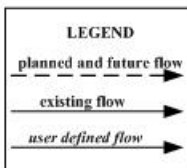
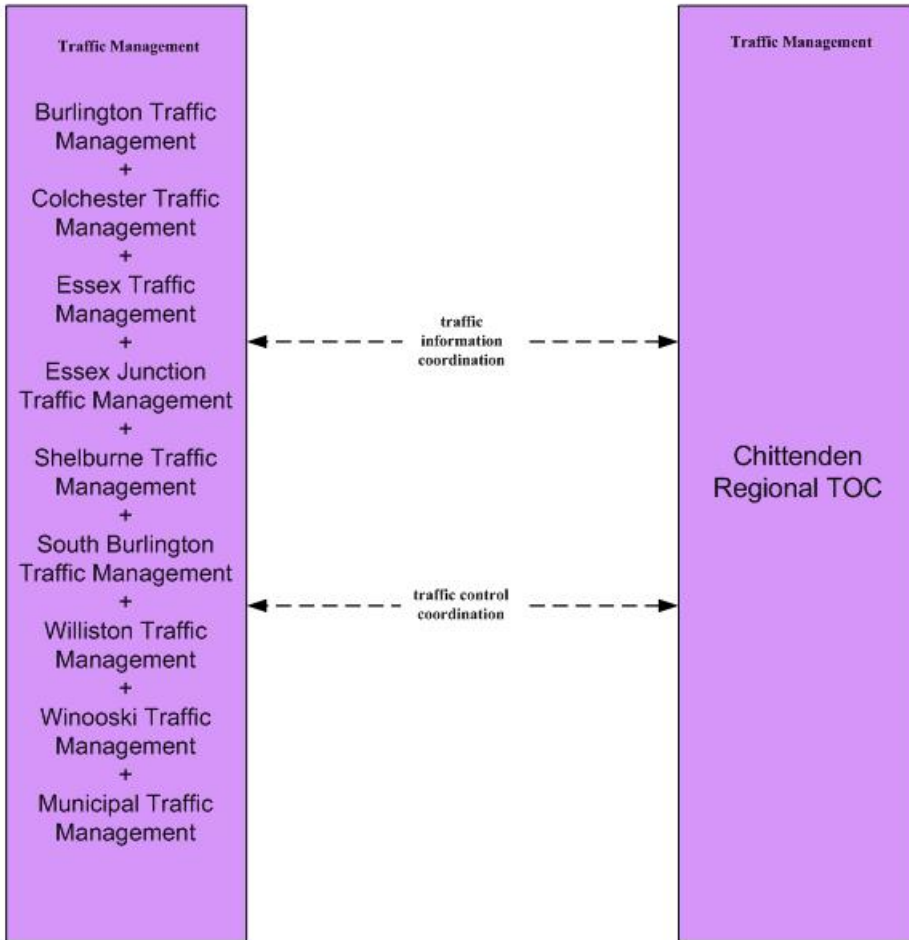

ATMS08 – Incident Management Colchester Traffic Management

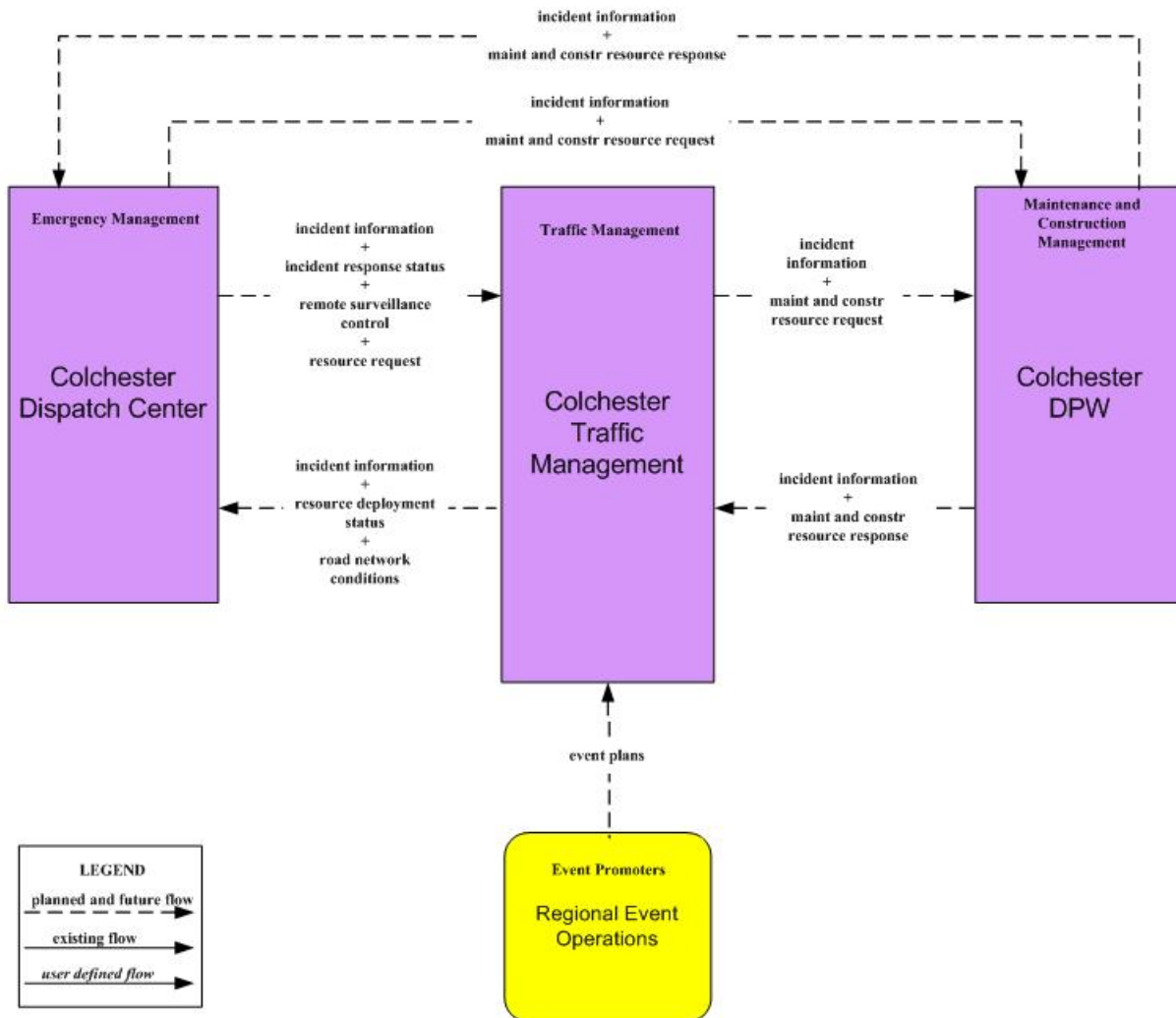

ATMS08 – Incident Management
Chittenden Regional TOC

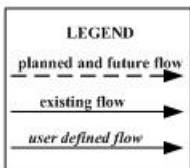
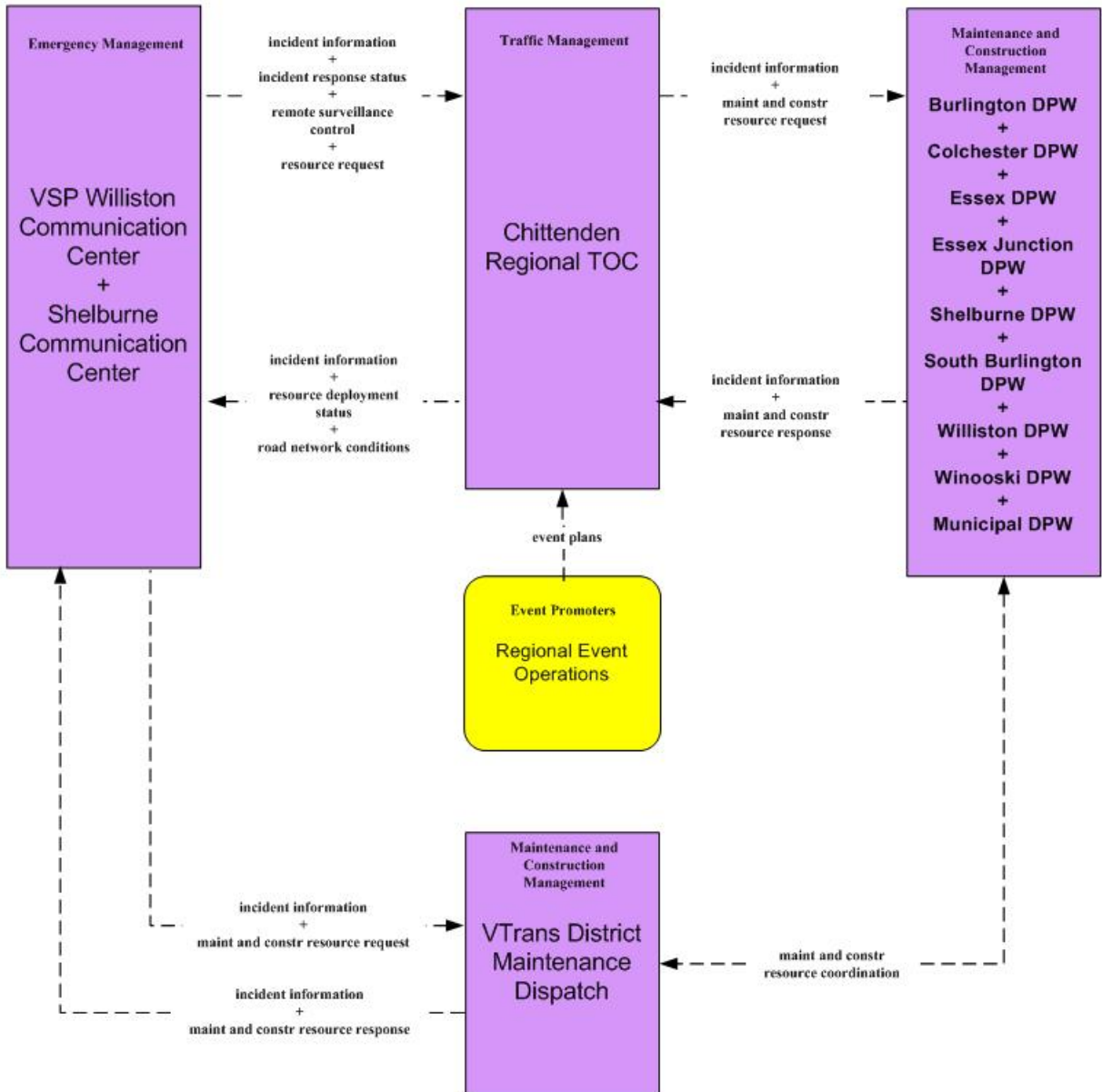

ATMS13 - Standard Railroad Grade Crossing
Colchester Traffic Management

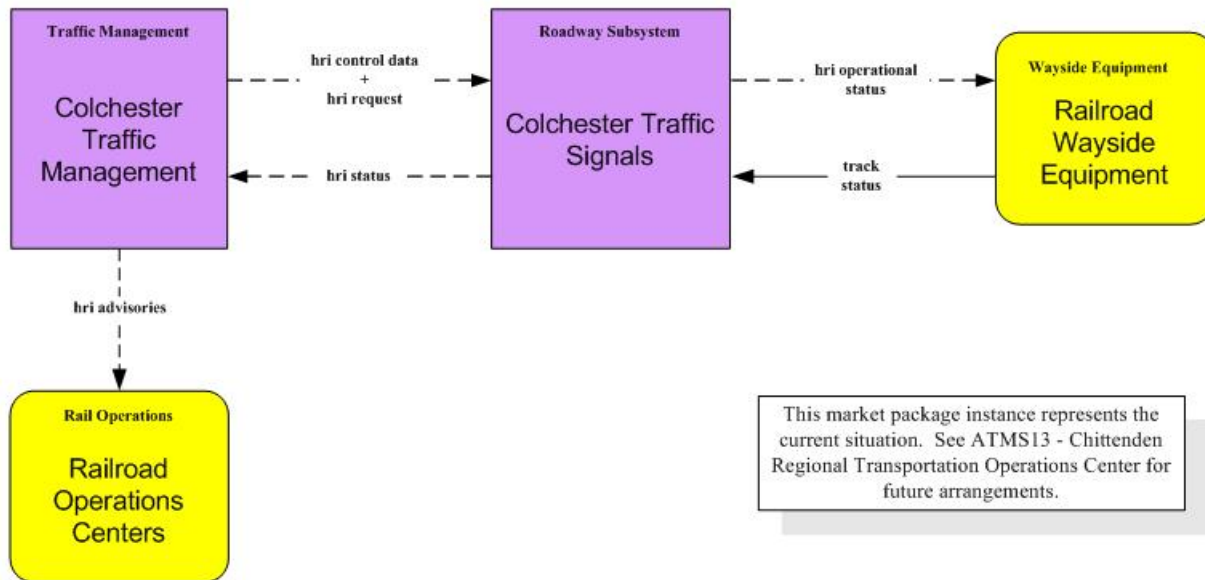

This market package instance represents the current situation. See ATMS13 - Chittenden Regional Transportation Operations Center for future arrangements.

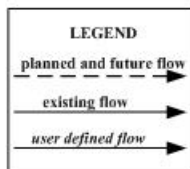

**ATMS13 - Standard Railroad Grade Crossing
Chittenden Regional Traffic Operations Center (Future)**

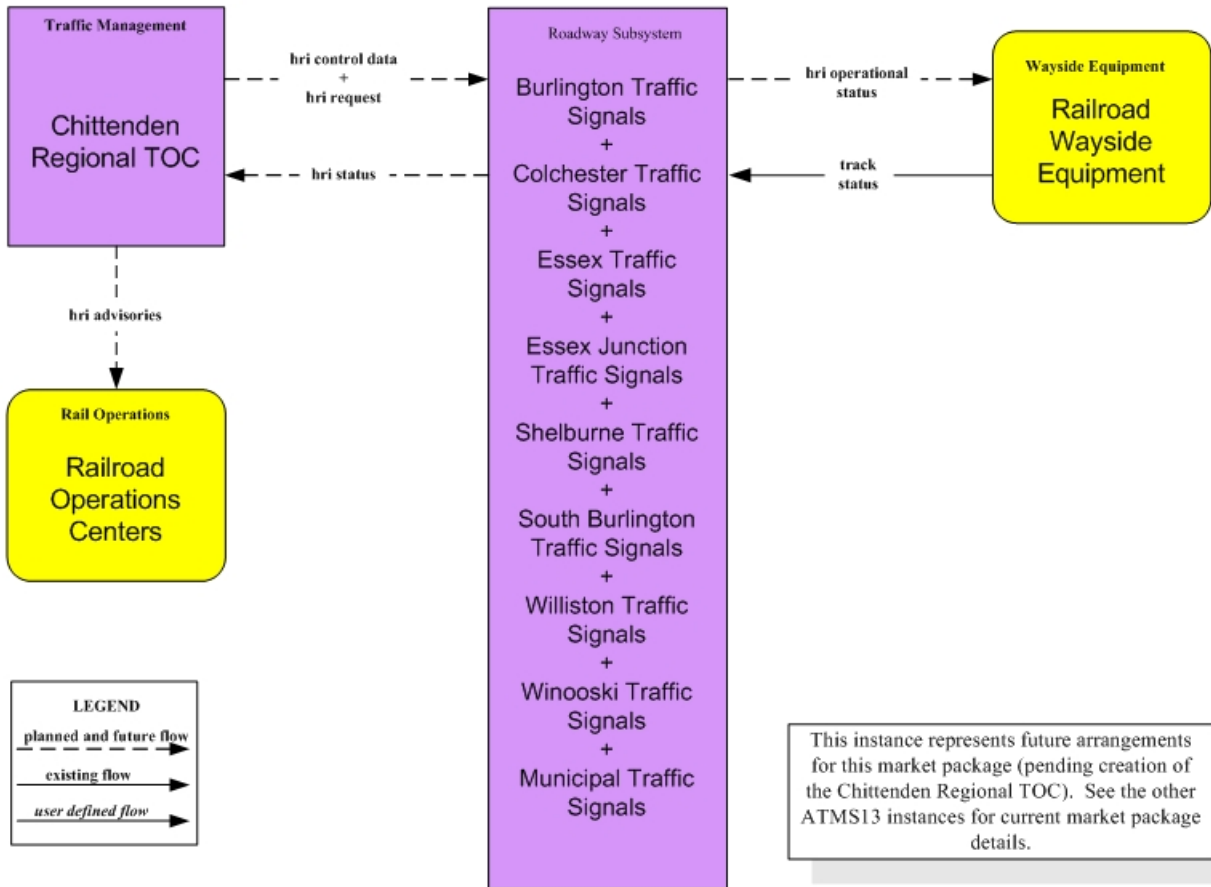

ATMS15 – Railroad Operations Coordination

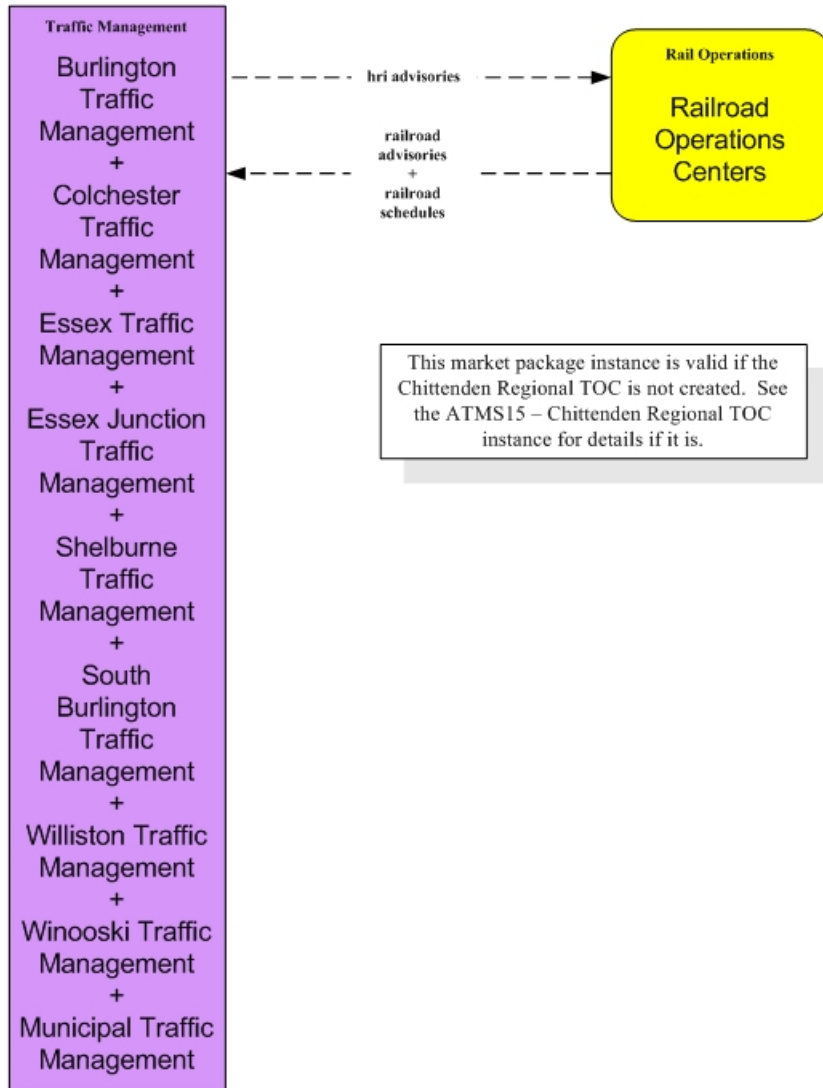

This market package instance is valid if the Chittenden Regional TOC is not created. See the ATMS15 – Chittenden Regional TOC instance for details if it is.

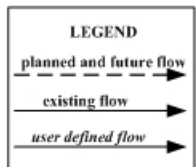

EMO2 – Emergency Routing 1 of 2 - Colchester

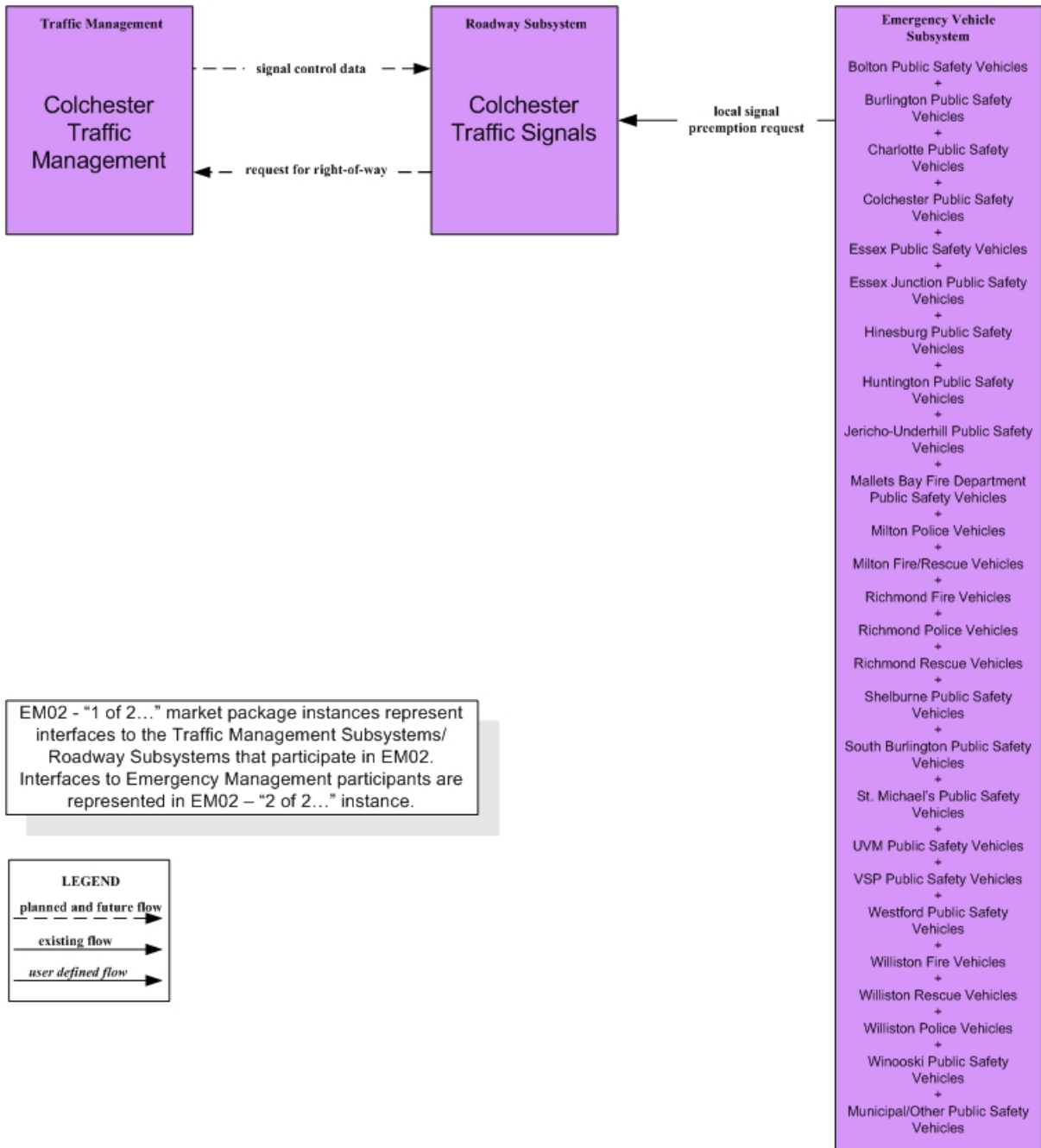

EMO2 - "1 of 2..." market package instances represent interfaces to the Traffic Management Subsystems/ Roadway Subsystems that participate in EMO2. Interfaces to Emergency Management participants are represented in EMO2 - "2 of 2..." instance.

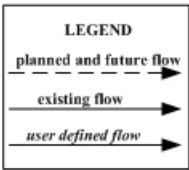

EMO2 – Emergency Routing
1 of 2 - Chittenden Regional TOC

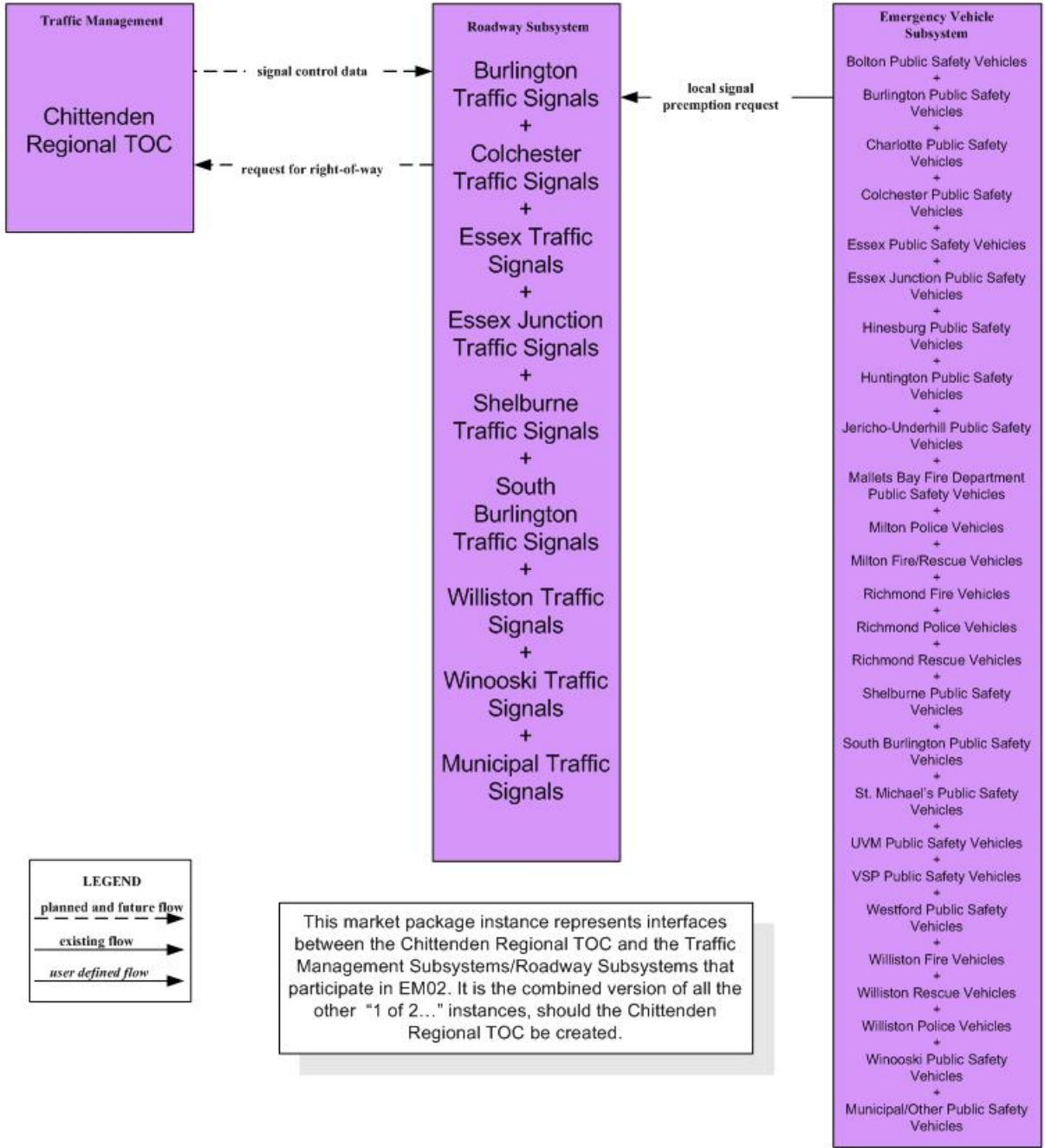

EMO2 – Emergency Routing

2 of 2 – Emergency Management

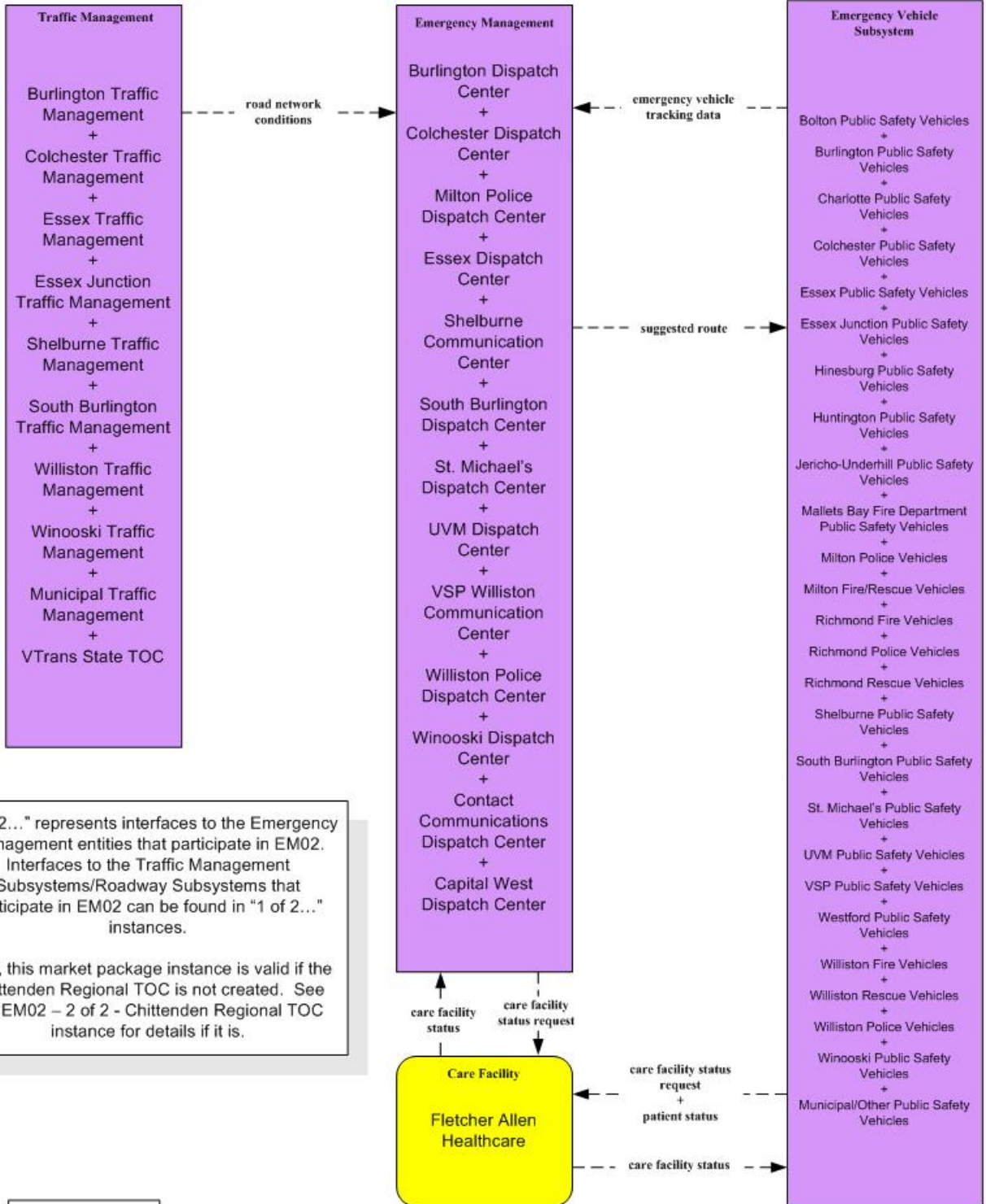

"2 of 2..." represents interfaces to the Emergency Management entities that participate in EM02. Interfaces to the Traffic Management Subsystems/Roadway Subsystems that participate in EM02 can be found in "1 of 2..." instances.

Also, this market package instance is valid if the Chittenden Regional TOC is not created. See the EM02 – 2 of 2 - Chittenden Regional TOC instance for details if it is.

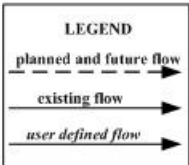

**EMO6 – Wide Area Alert
Vermont Statewide EOC & VSP Headquarters**

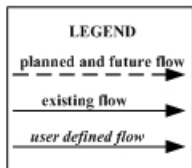
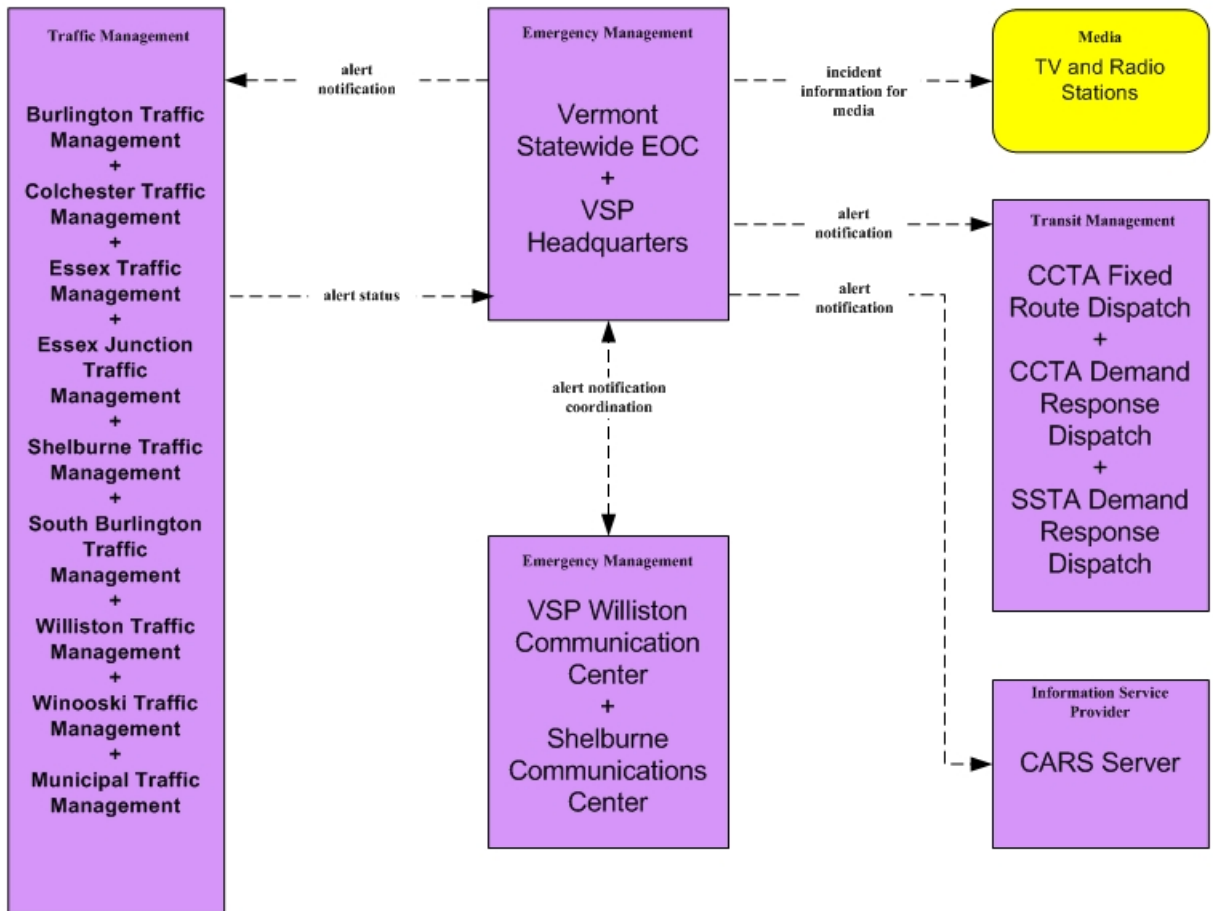

EM09 - Evacuation and Reentry Management
Vermont Statewide EOC

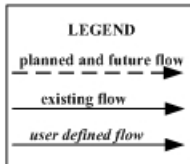
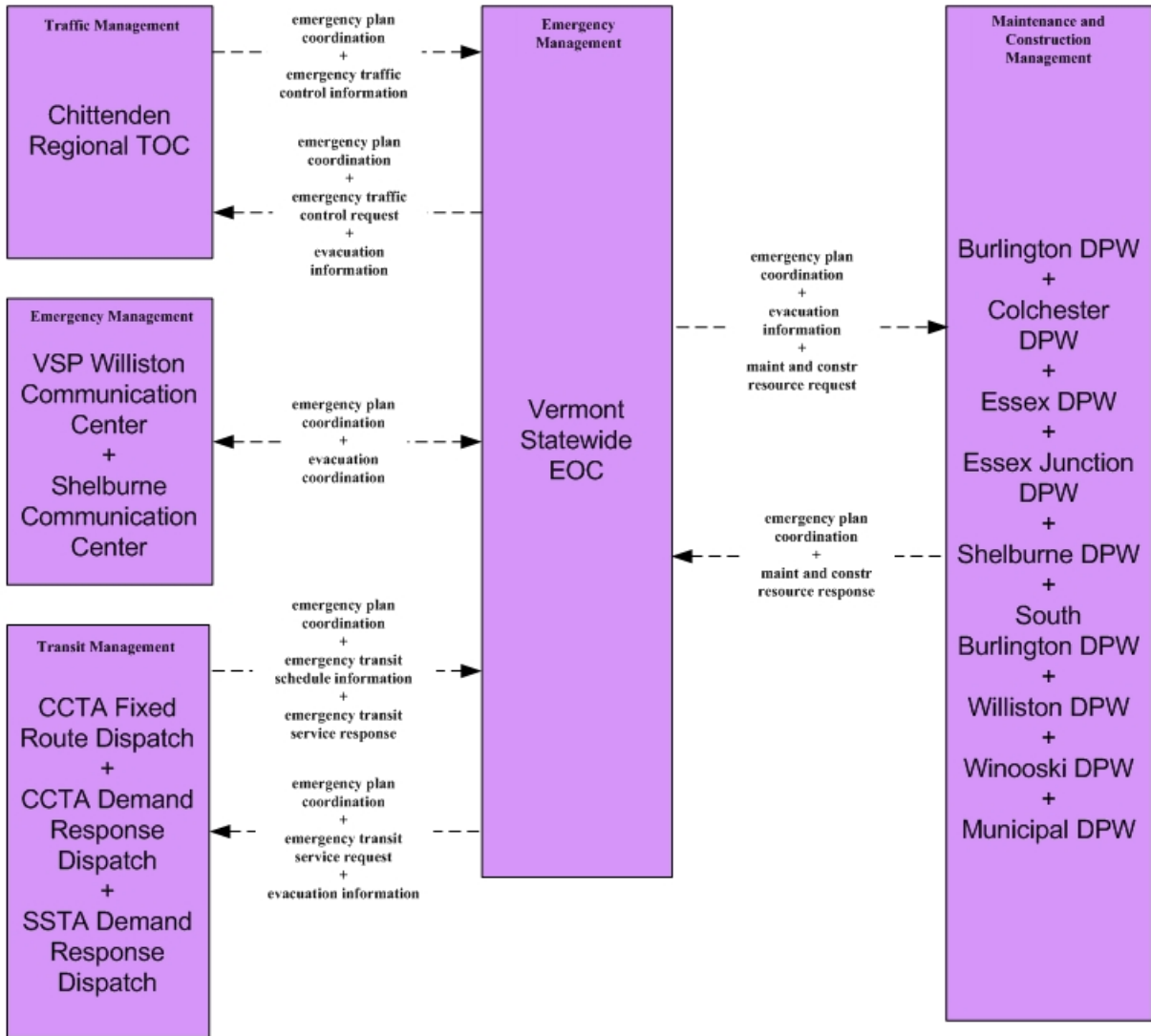

MC01 – Maintenance and Construction Vehicle Tracking
Colchester DPW

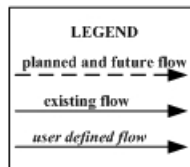
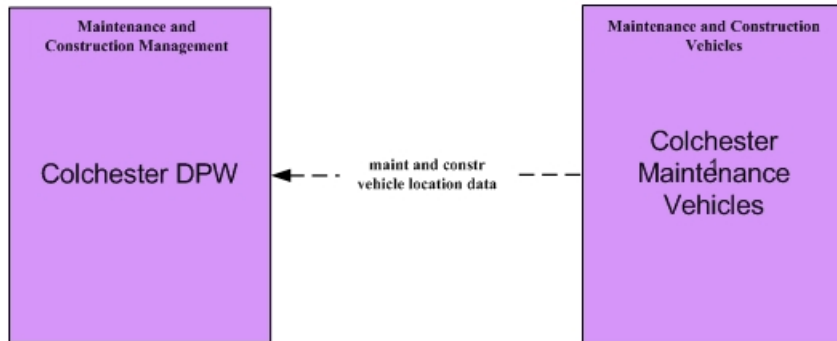

MC02 – Maintenance and Construction Vehicle Maintenance
Colchester DPW

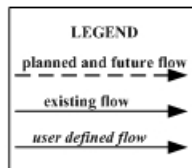
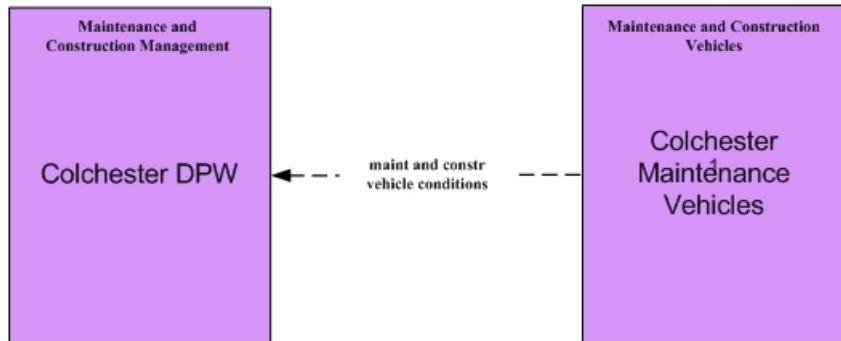

MC04 - Weather Information Processing and Distribution
Weather Services

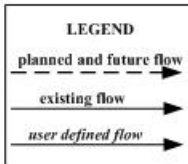
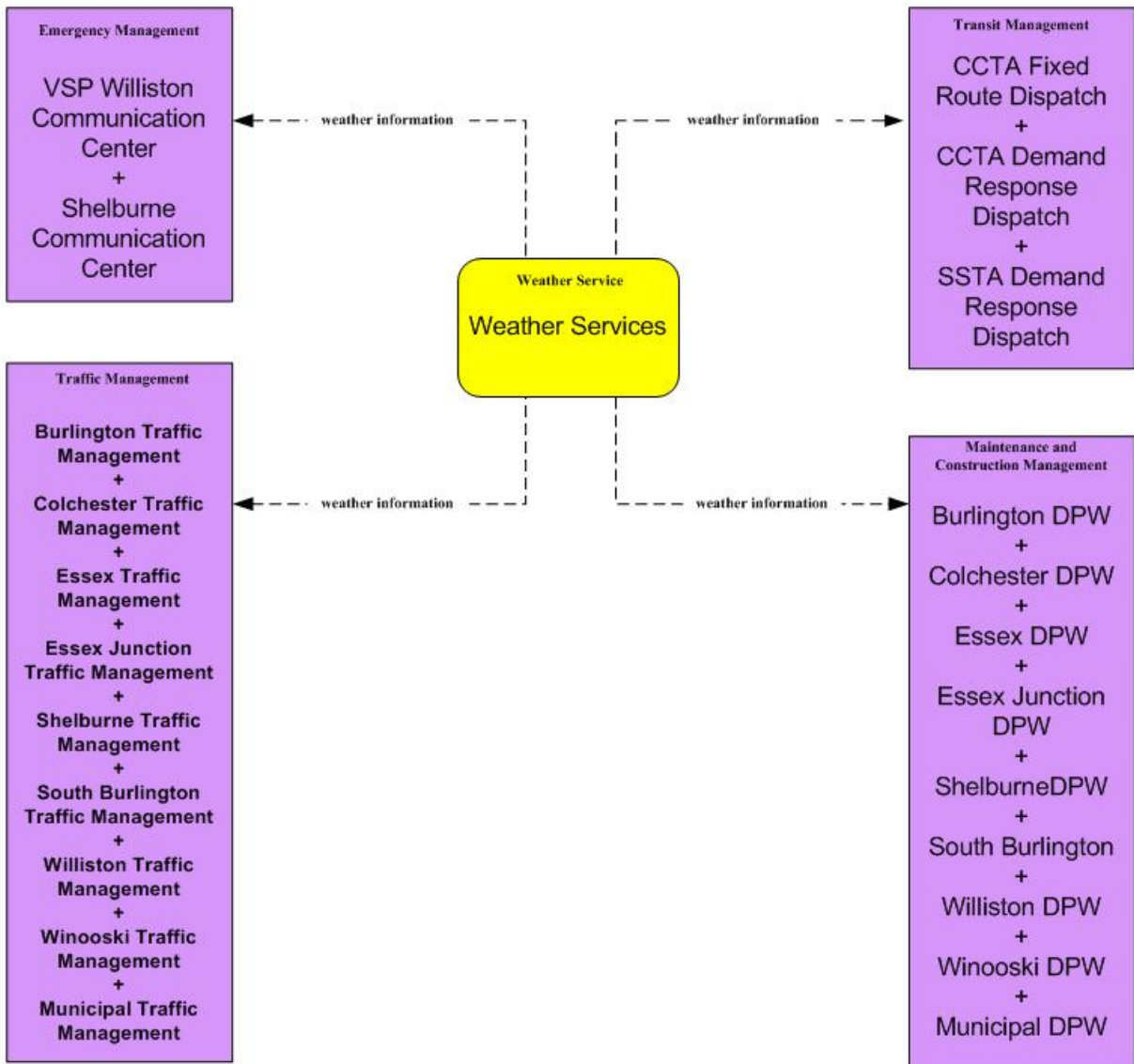

This instance represents the situation for this market package with existing entities only. See the MC04 – Weather Services (Chittenden Regional TOC) instance for market package details pending creation of the Chittenden Regional TOC.

MC04 - Weather Information Processing and Distribution
Weather Services – Chittenden Regional TOC

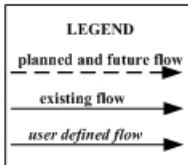
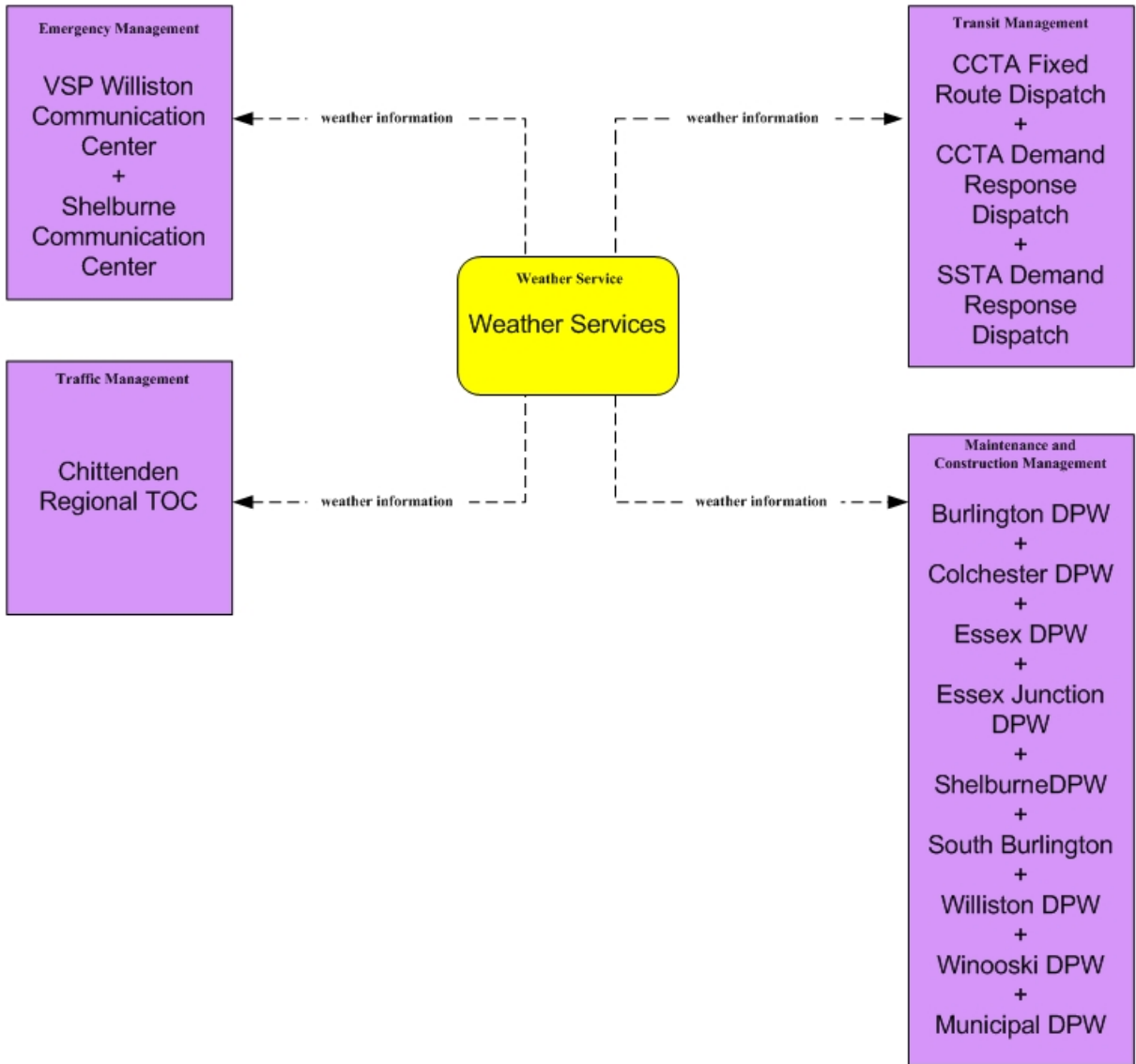

This instance represents the situation for this market package pending creation of the Chittenden Regional TOC. See the MC04 – Weather Services instance for market package details with existing entities only.

MC06 - Winter Maintenance
Colchester DPW

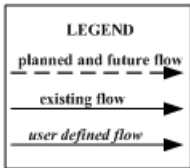
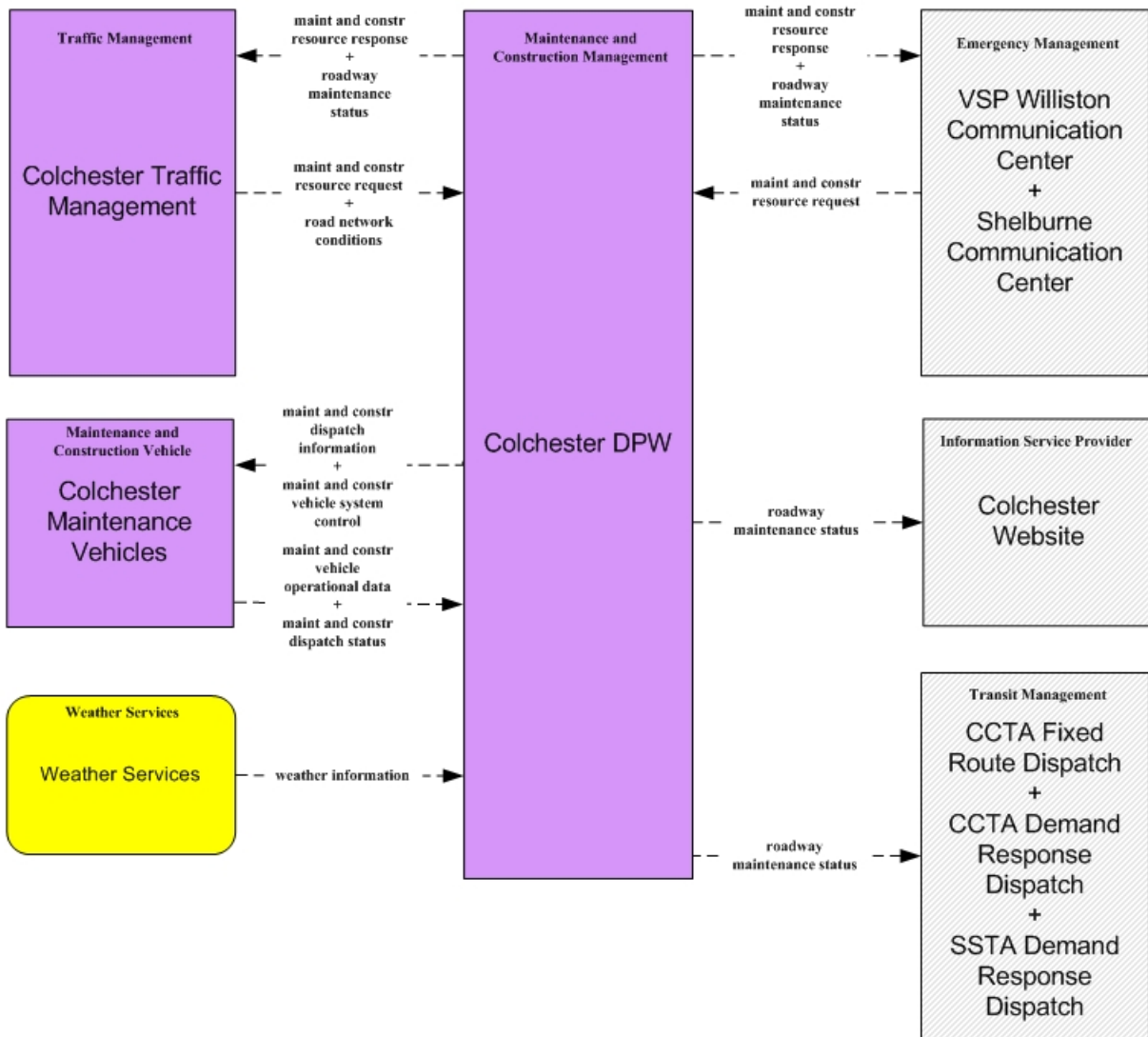

MC07 - Roadway Maintenance and Construction
Colchester DPW

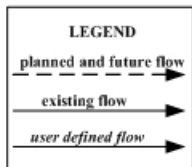
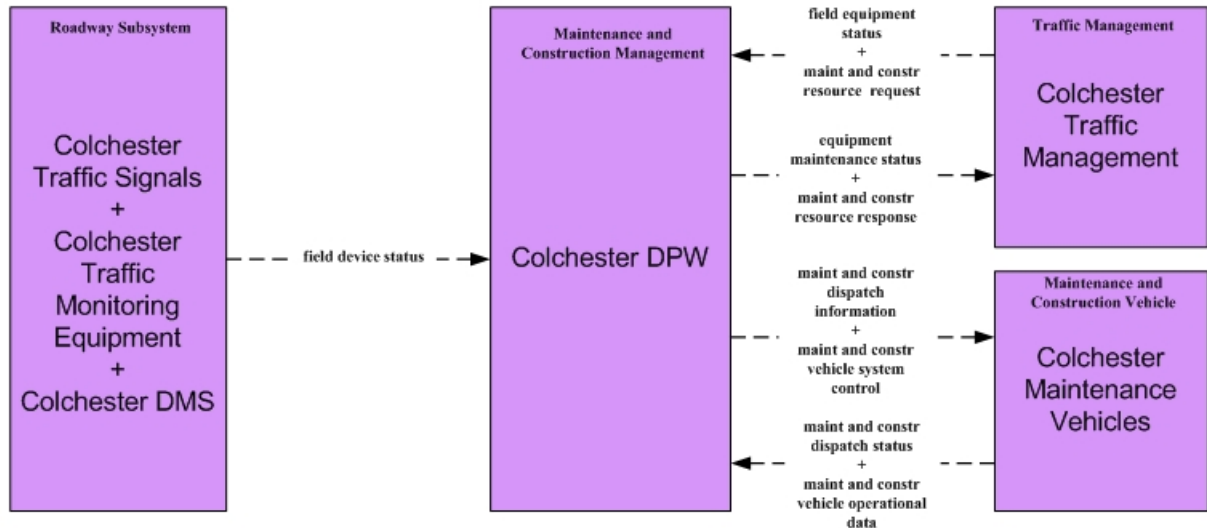

MC08 - Work Zone Management
Colchester DPW

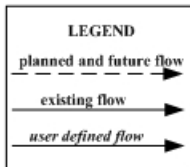
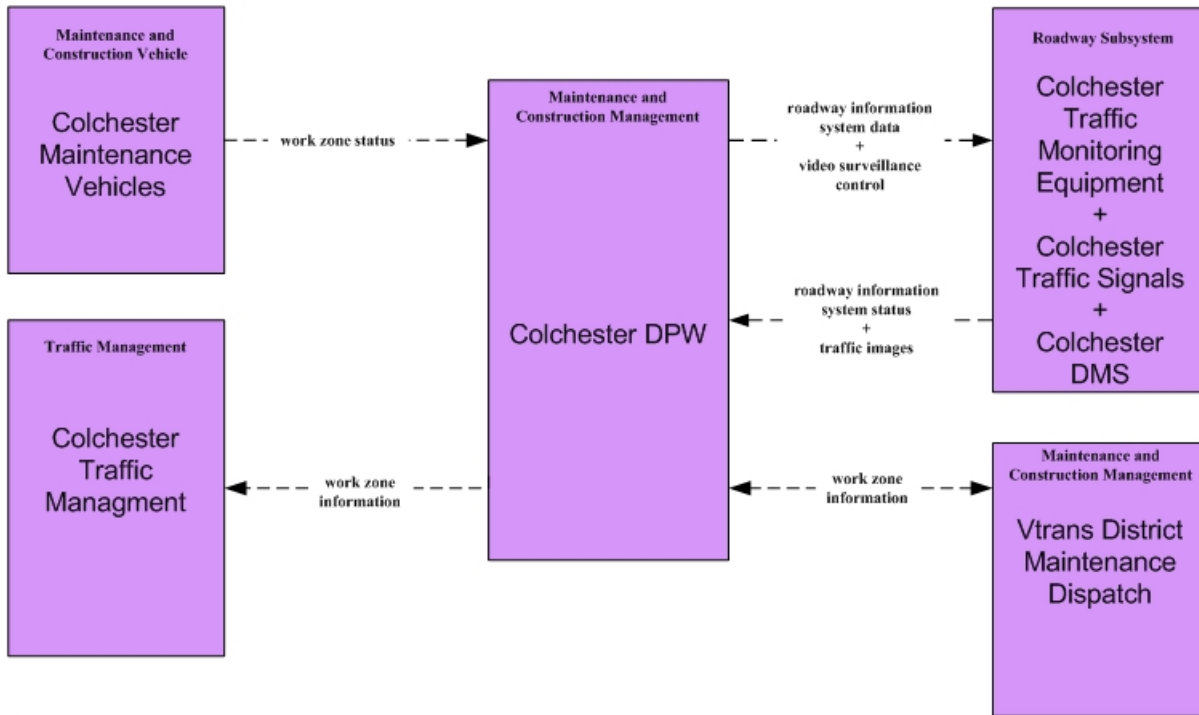

MC08 - Work Zone Management
VTrans District Maintenance Dispatch

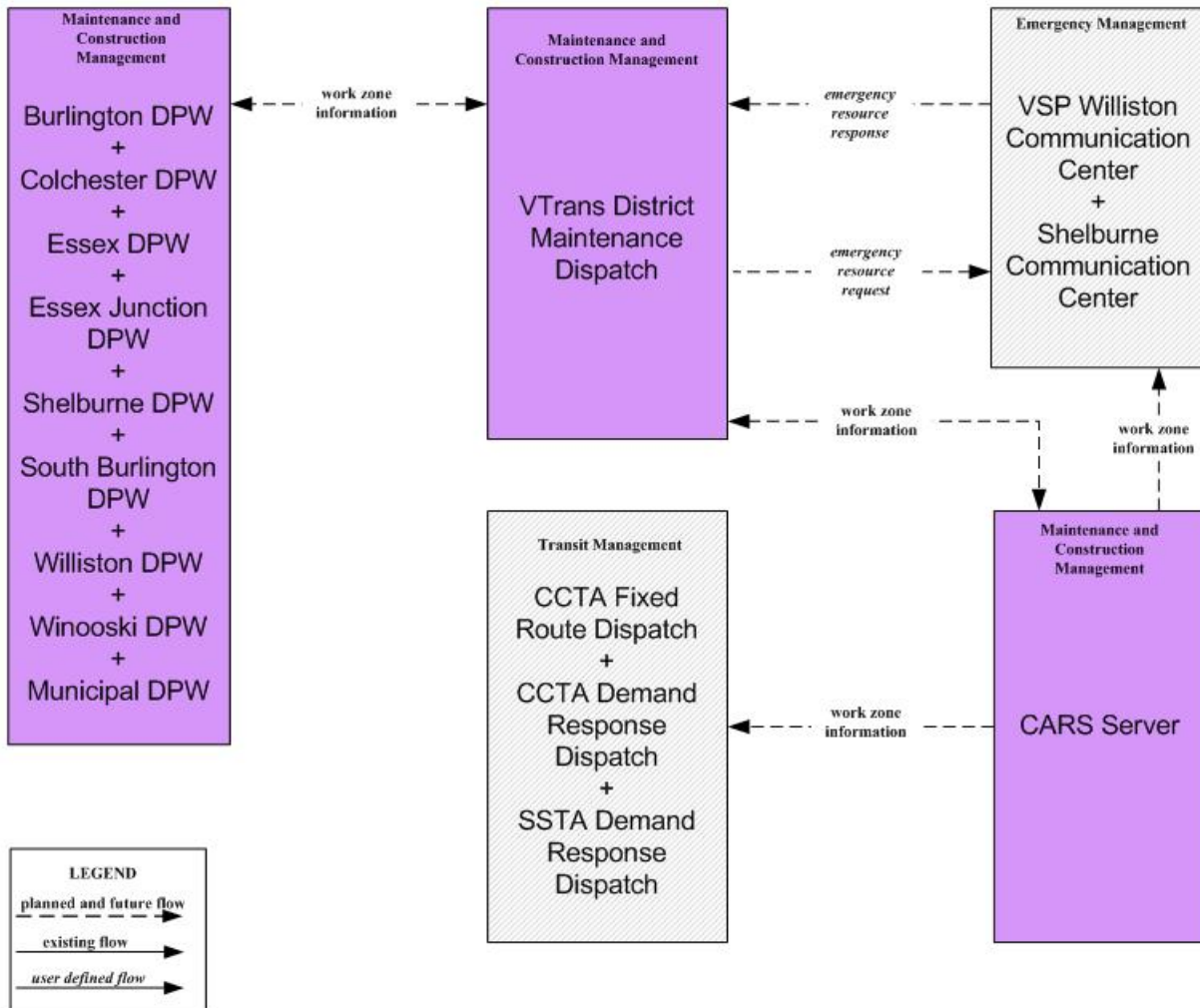

MC10 – Maintenance and Construction Activity Coordination
Colchester DPW

