

AD1 - ITS Data Mart  
Burlington Data Repository

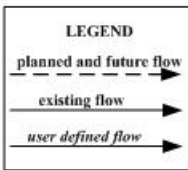

AD2 - ITS Data Warehouse  
CCMPO Data Warehouse

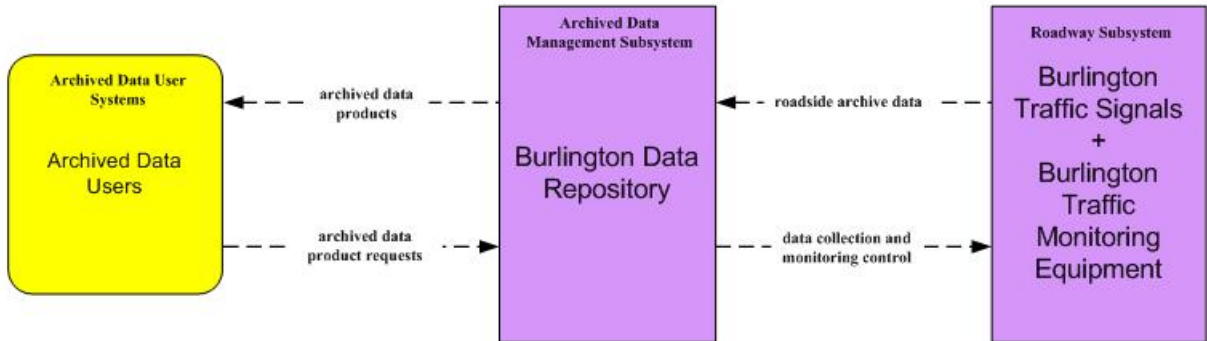
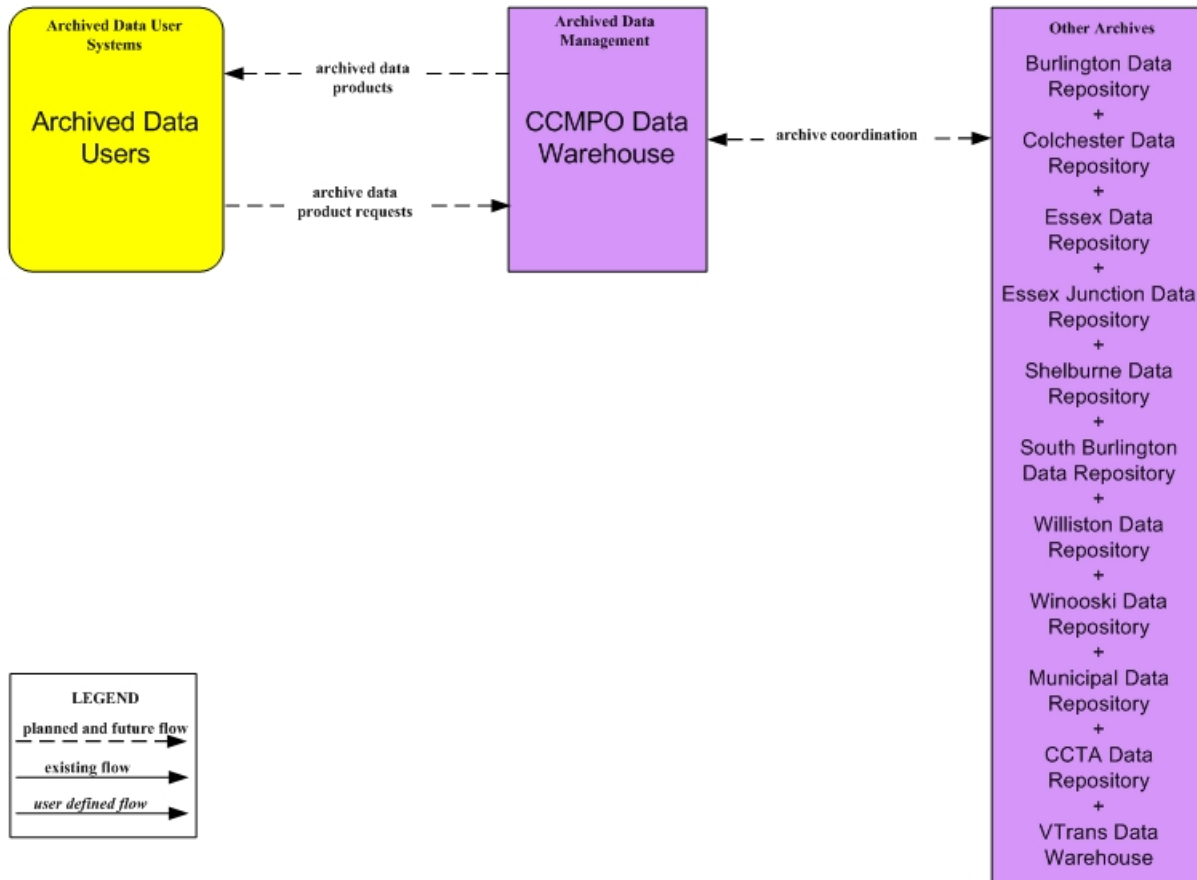

**APTS7 – Multimodal Coordination**  
**CCTA Fixed Route Dispatch – Chittenden Regional TOC and VTrans State TOC**

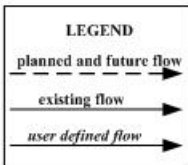
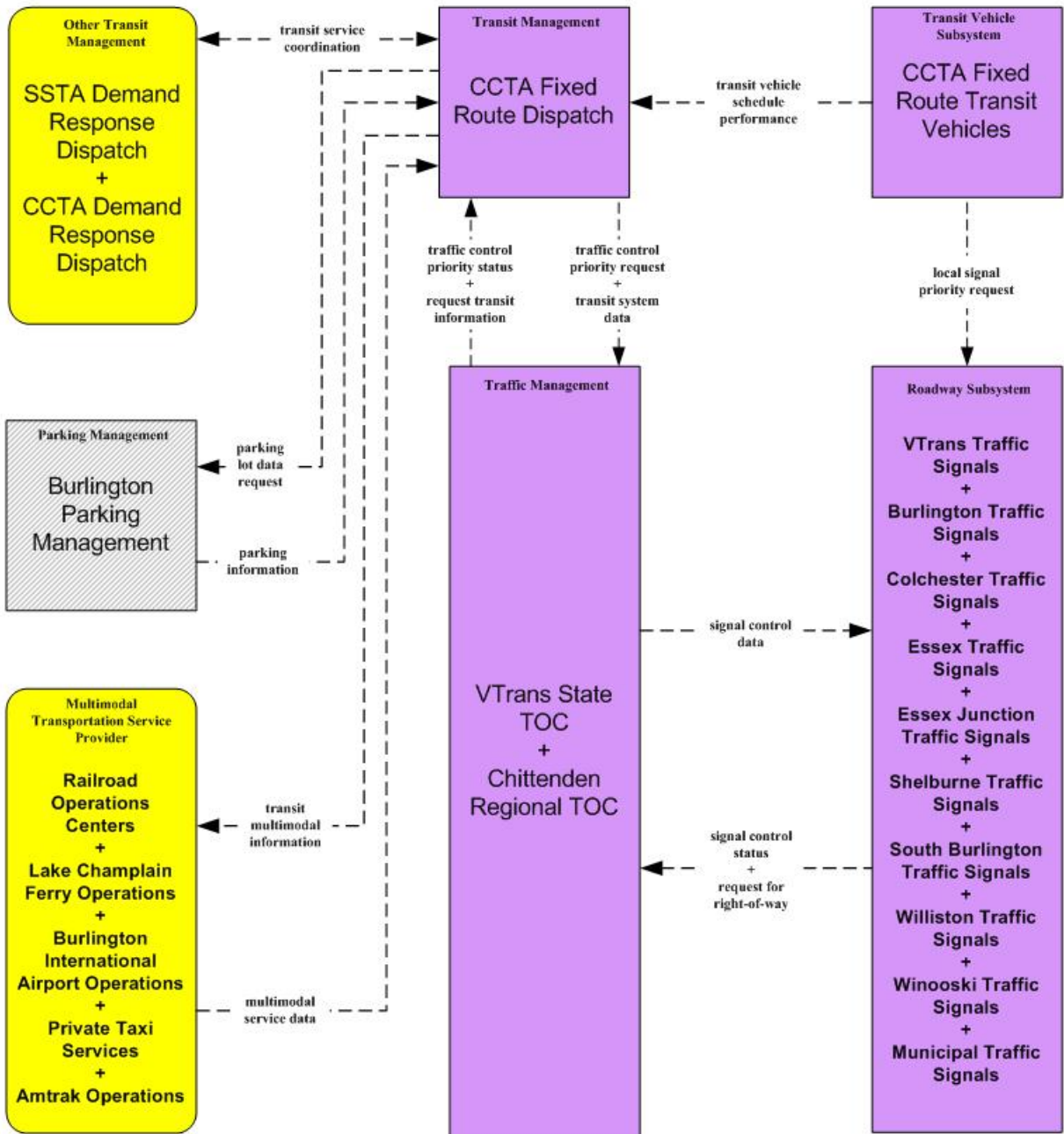

This market package instance is pending creation of the Chittenden Regional TOC. See the other APTS7 instance for details if it is not.

APTS7 – Multimodal Coordination  
CCTA Fixed Route Dispatch

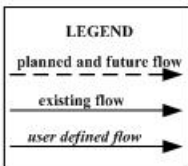
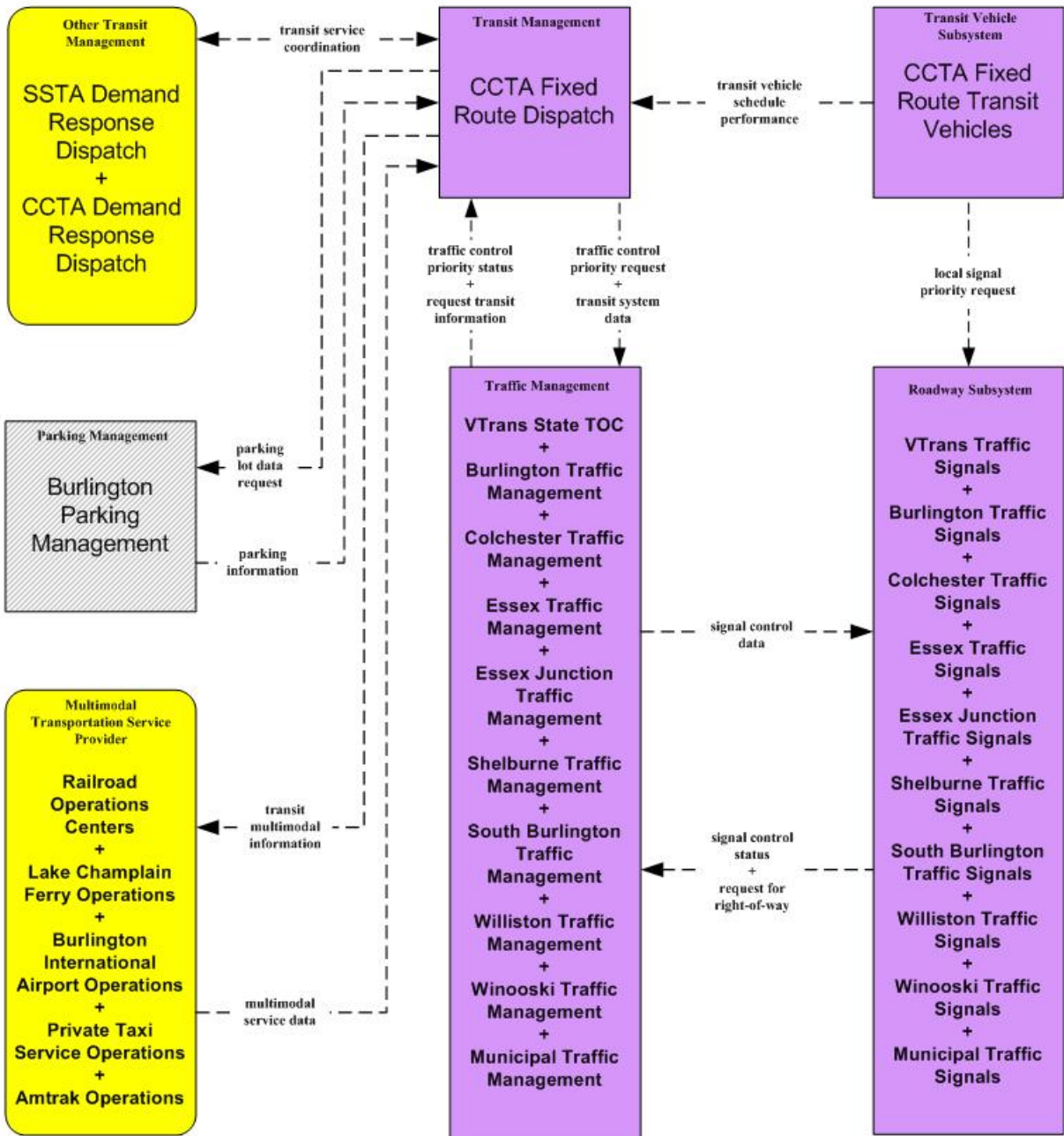

This market package instance is valid if the Chittenden Regional TOC is not created. See the APTS7 – Chittenden Regional TOC instance for details if it is.

# ATIS1 - Broadcast Traveler Information Burlington Website

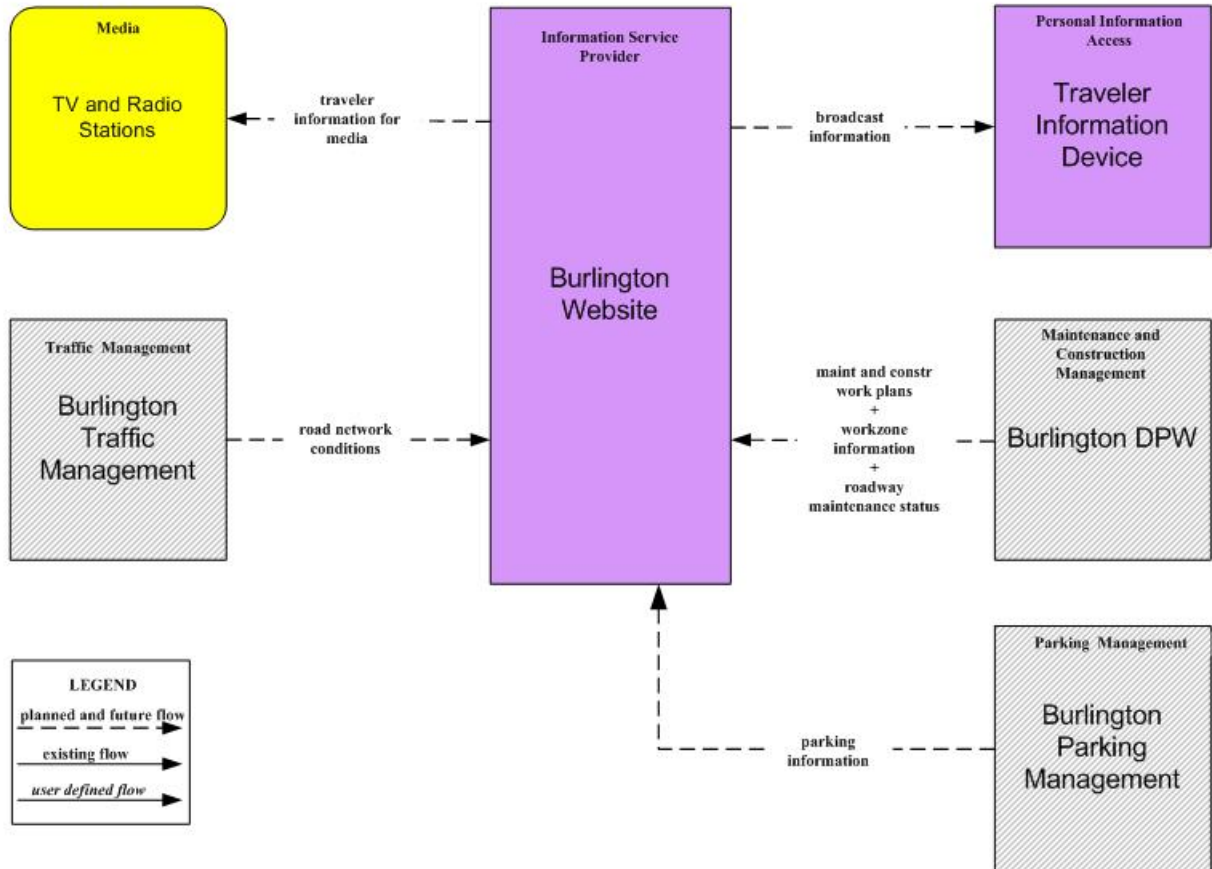

# ATIS1 - Broadcast Traveler Information CARS Information System

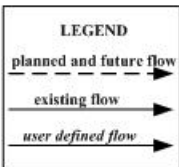
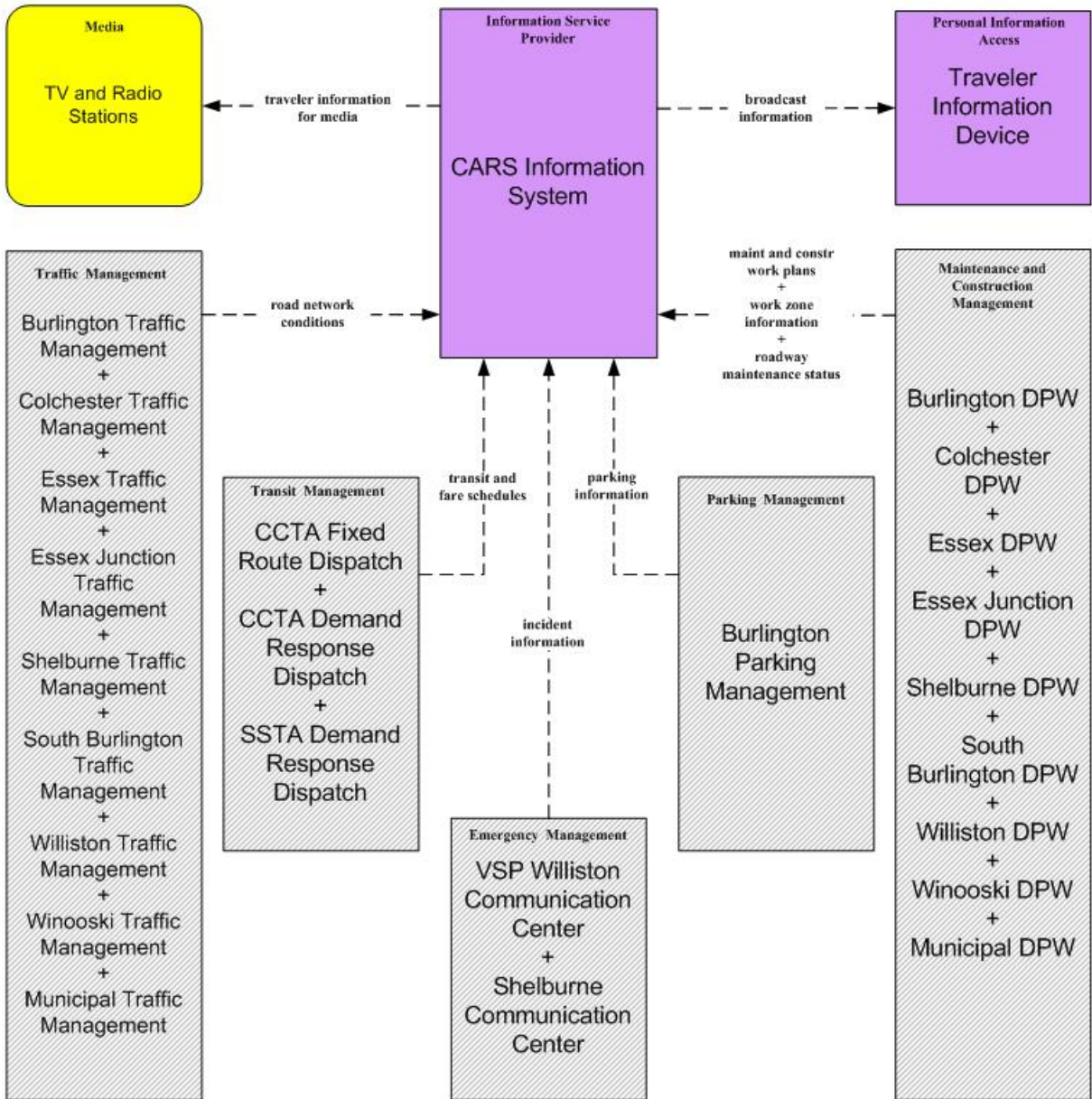

This market package instance is valid if the Chittenden Regional TOC is not created. See the ATIS1 – CARS – Chittenden Regional TOC instance for details if it is.

ATIS1 - Broadcast Traveler Information  
 CARS Information System – Chittenden Regional TOC

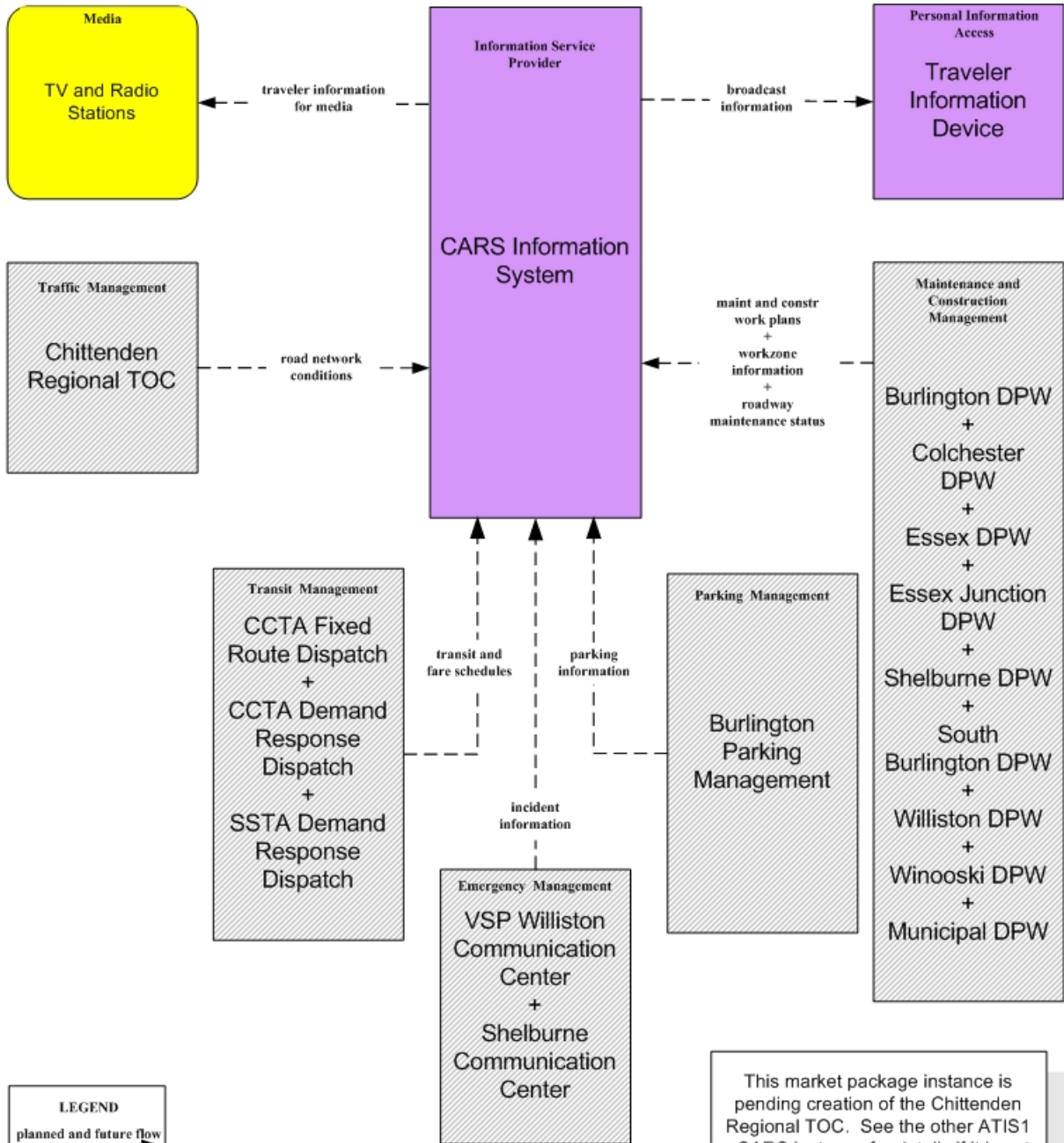

This market package instance is pending creation of the Chittenden Regional TOC. See the other ATIS1 - CARS instance for details if it is not.

# ATMS01 - Network Surveillance Burlington Traffic Management

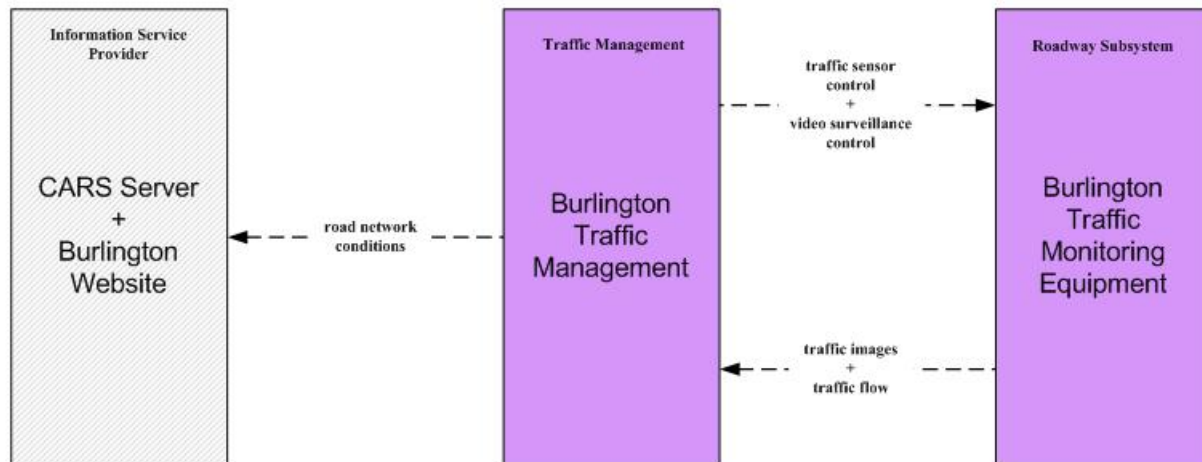

## LEGEND

planned and future flow →

existing flow →

*user defined flow* →



ATMS03 - Surface Street Control  
Burlington Traffic Management

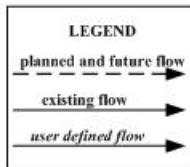
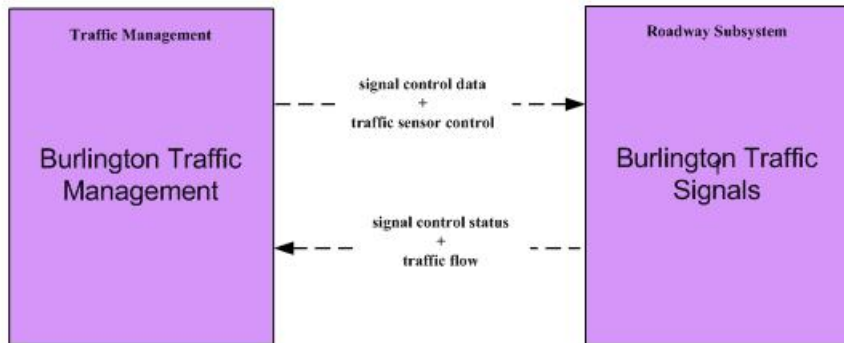

ATMS06 – Traffic Information Dissemination  
Burlington Traffic Management

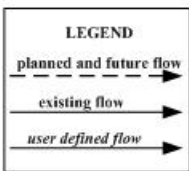
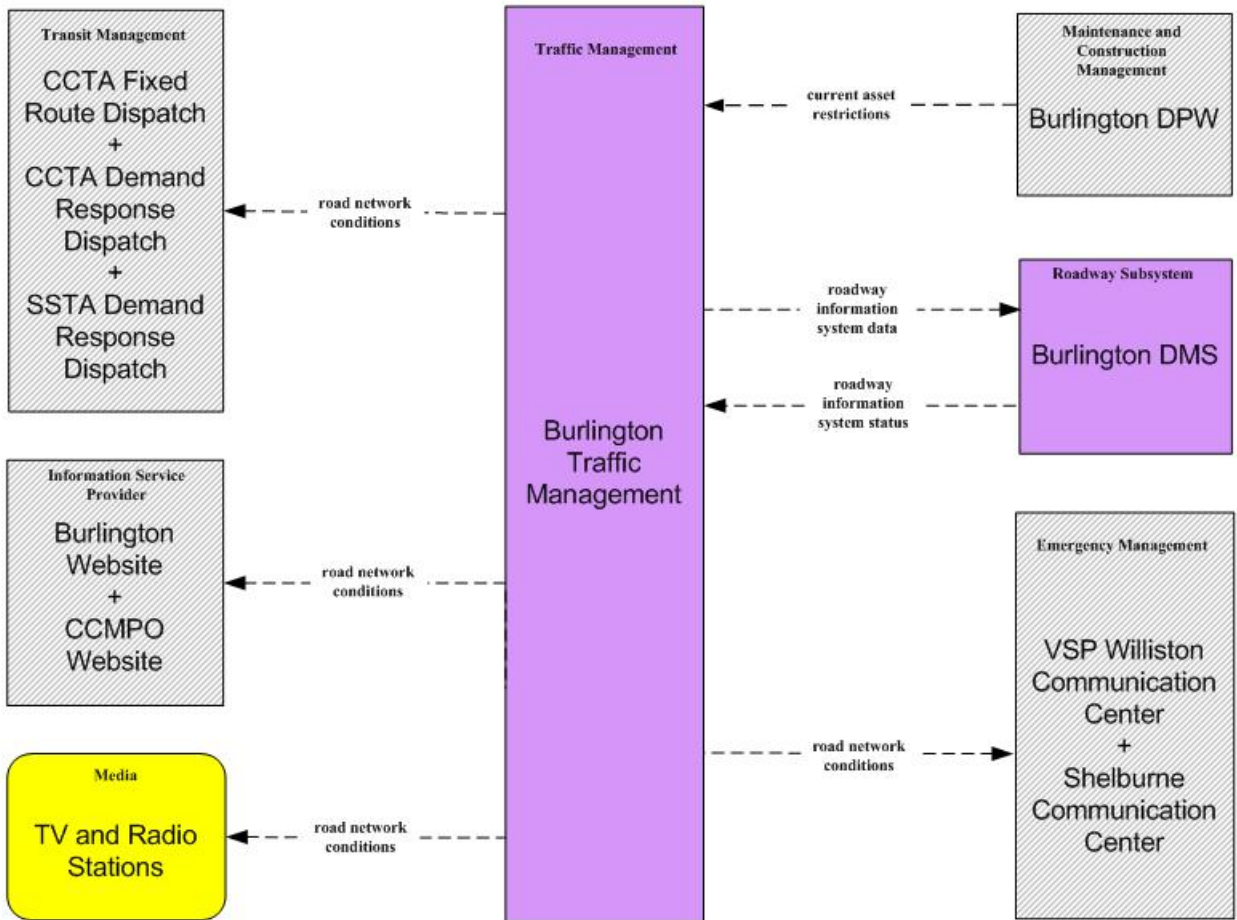

**ATMS06 – Traffic Information Dissemination  
Chittenden Regional TOC (Future)**

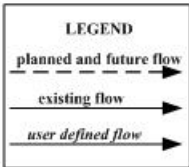
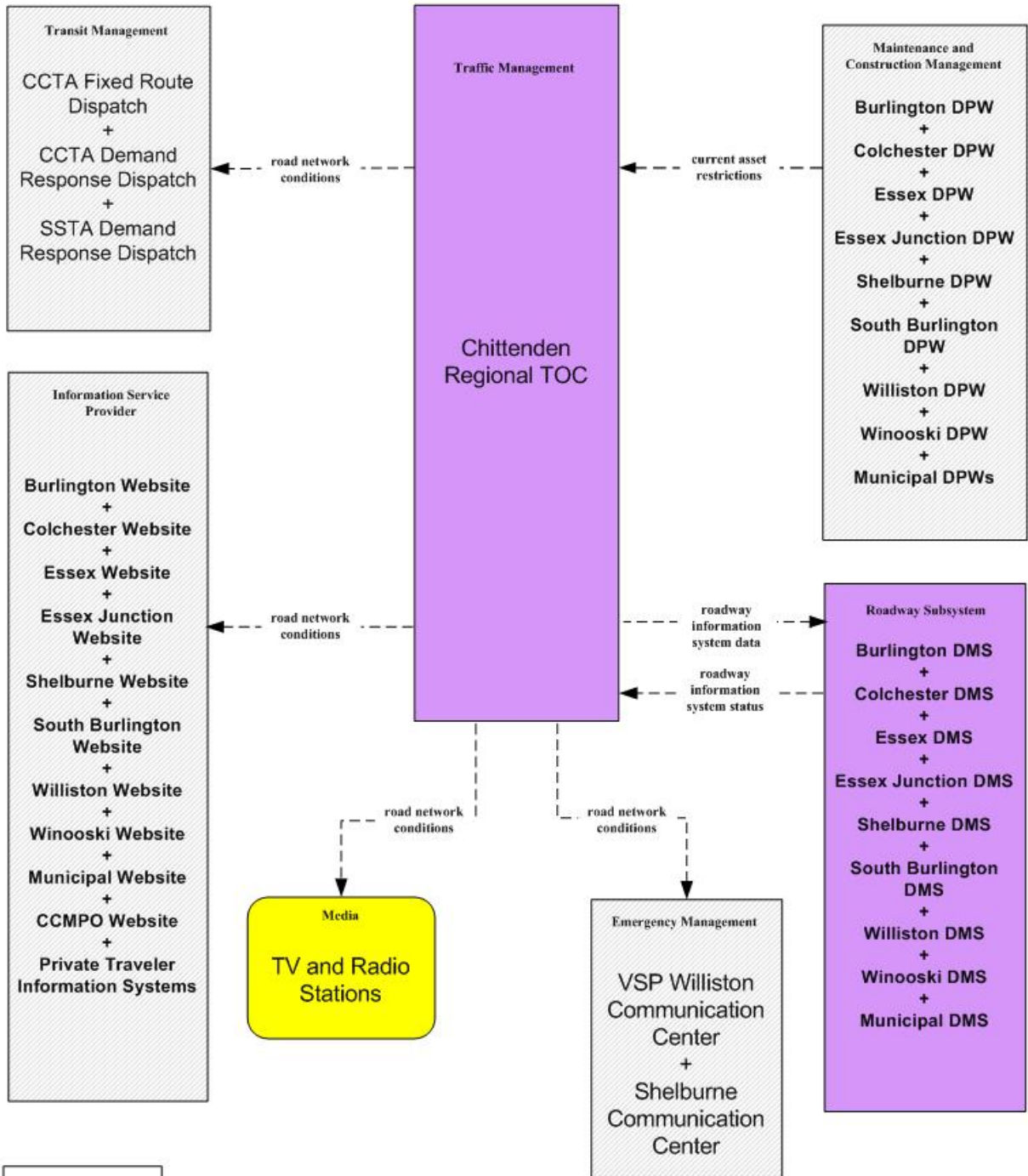

ATMS07 – Regional Traffic Control  
Chittenden Regional TOC

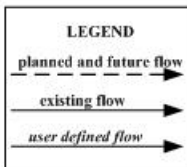
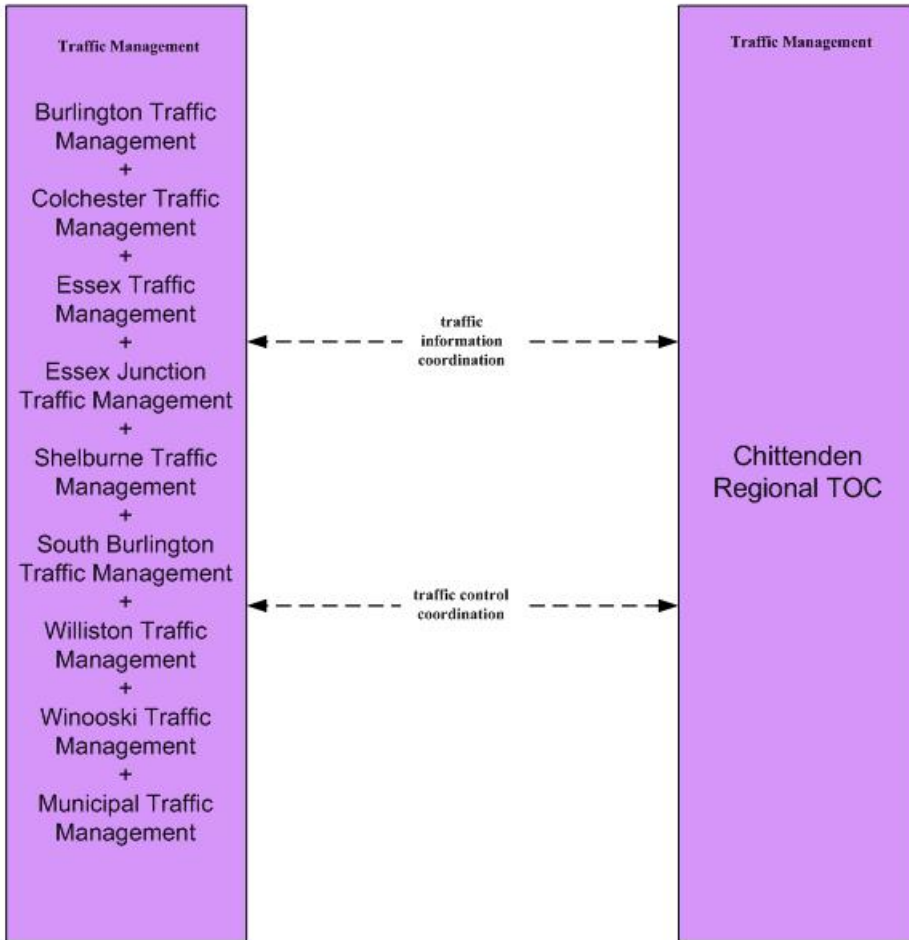

# ATMS08 – Incident Management Burlington Traffic Management

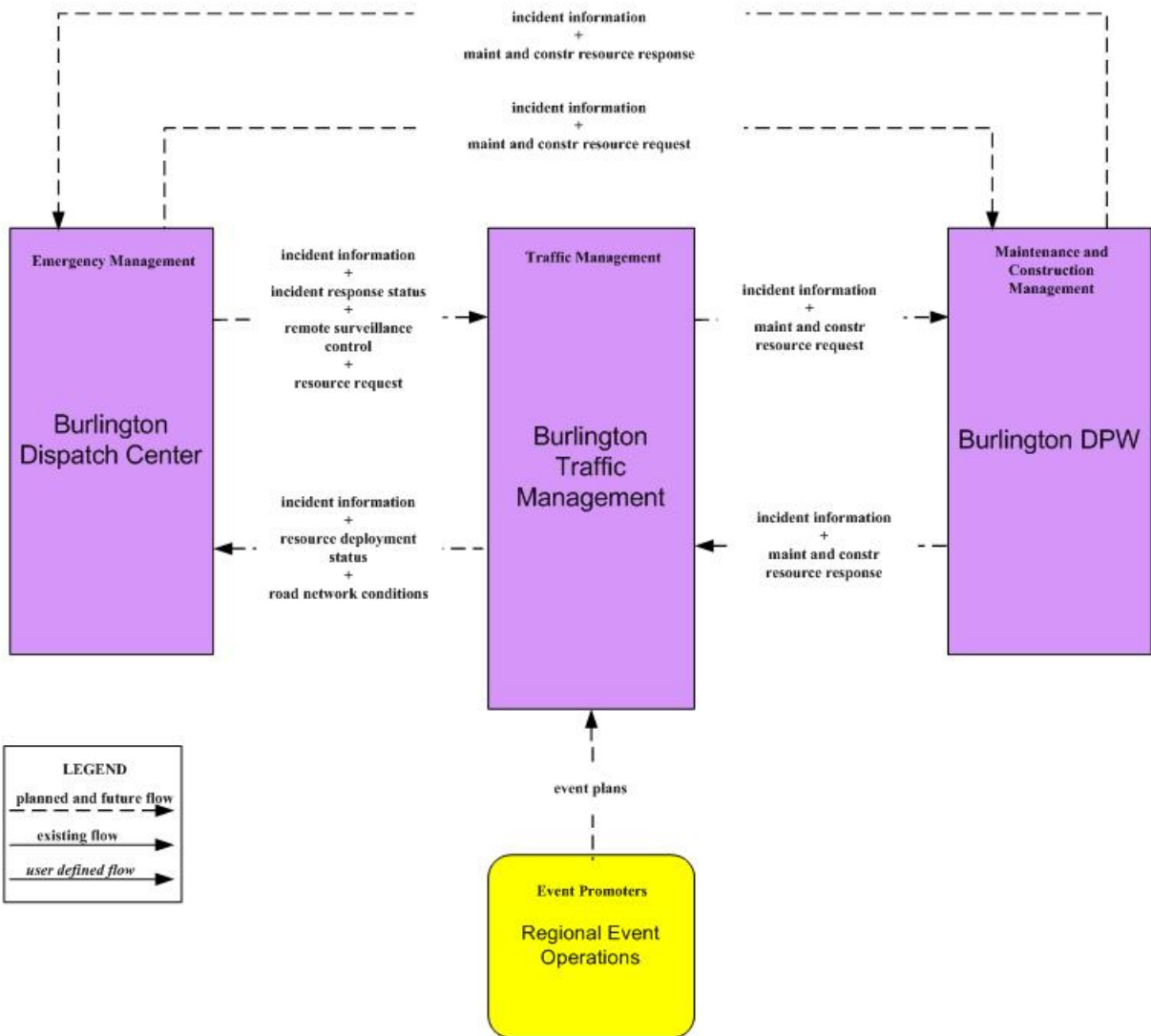

ATMS08 – Incident Management  
Chittenden Regional TOC

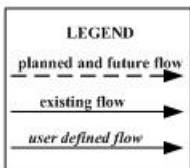
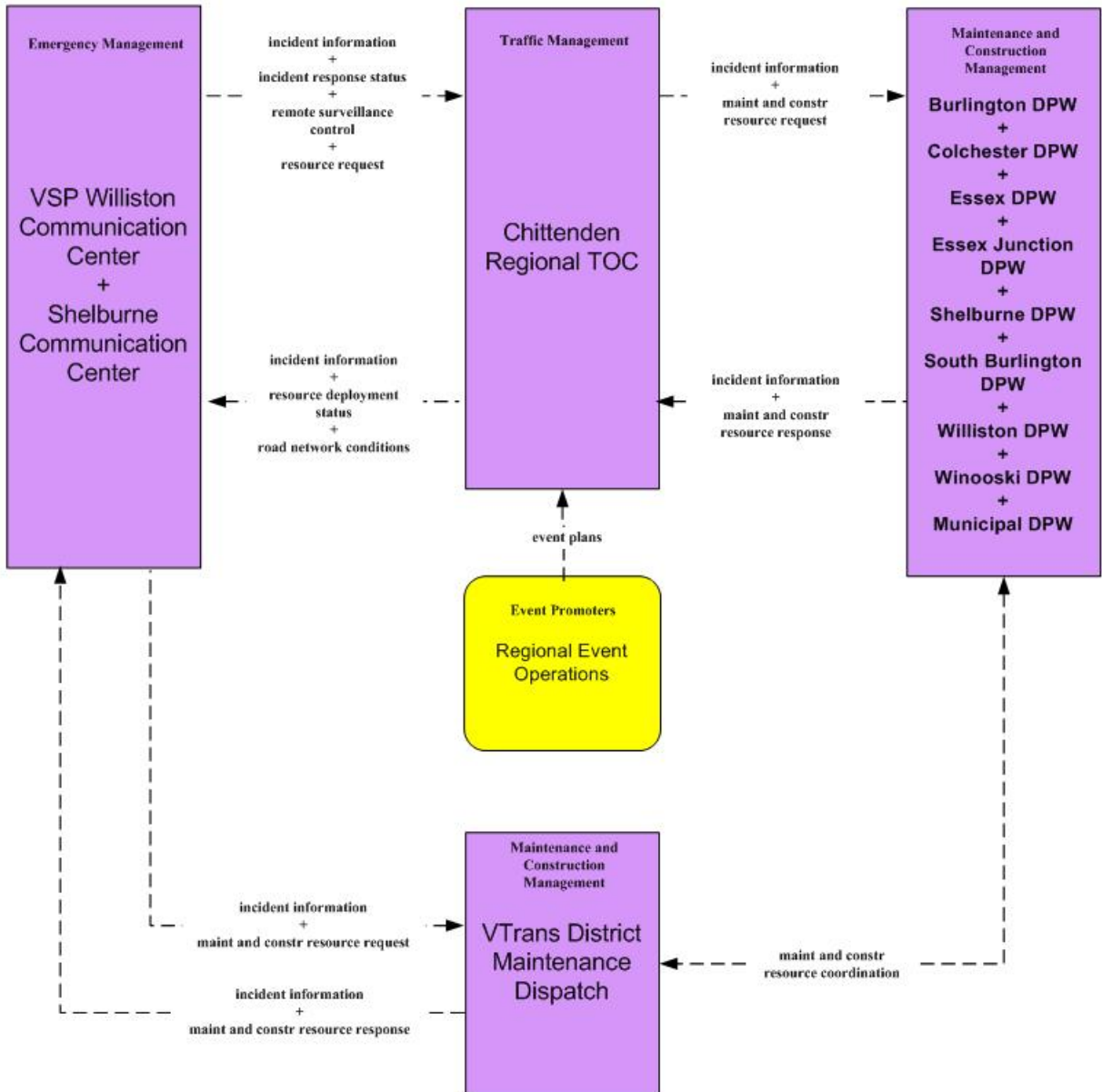

ATMS13 - Standard Railroad Grade Crossing  
Burlington Traffic Management

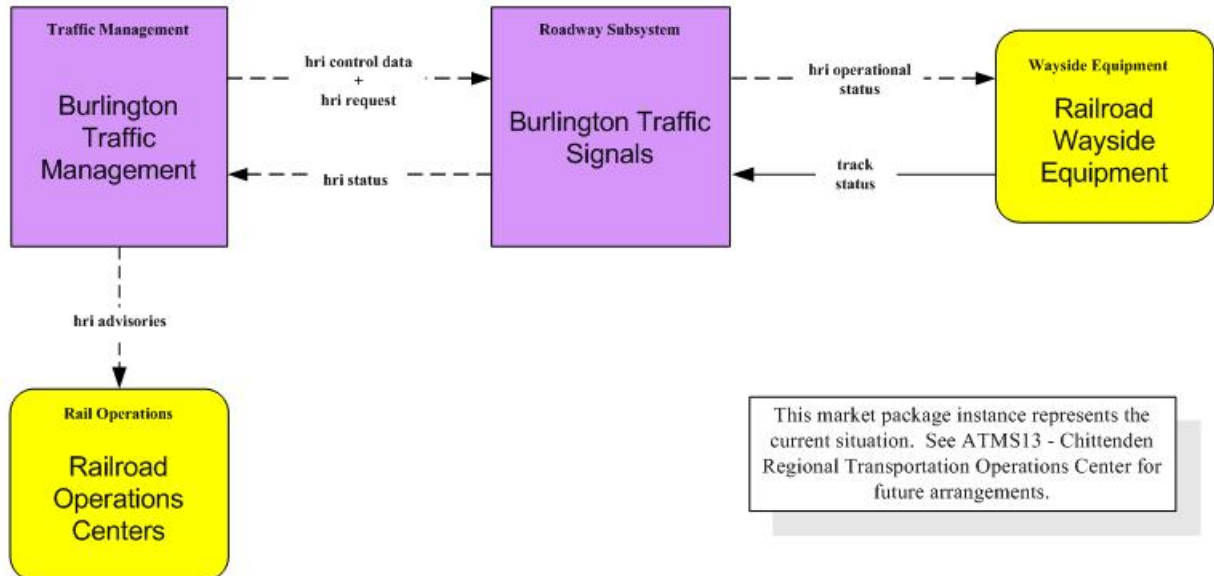

This market package instance represents the current situation. See ATMS13 - Chittenden Regional Transportation Operations Center for future arrangements.

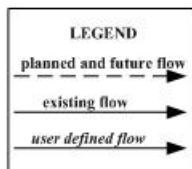

**ATMS13 - Standard Railroad Grade Crossing  
Chittenden Regional Traffic Operations Center (Future)**

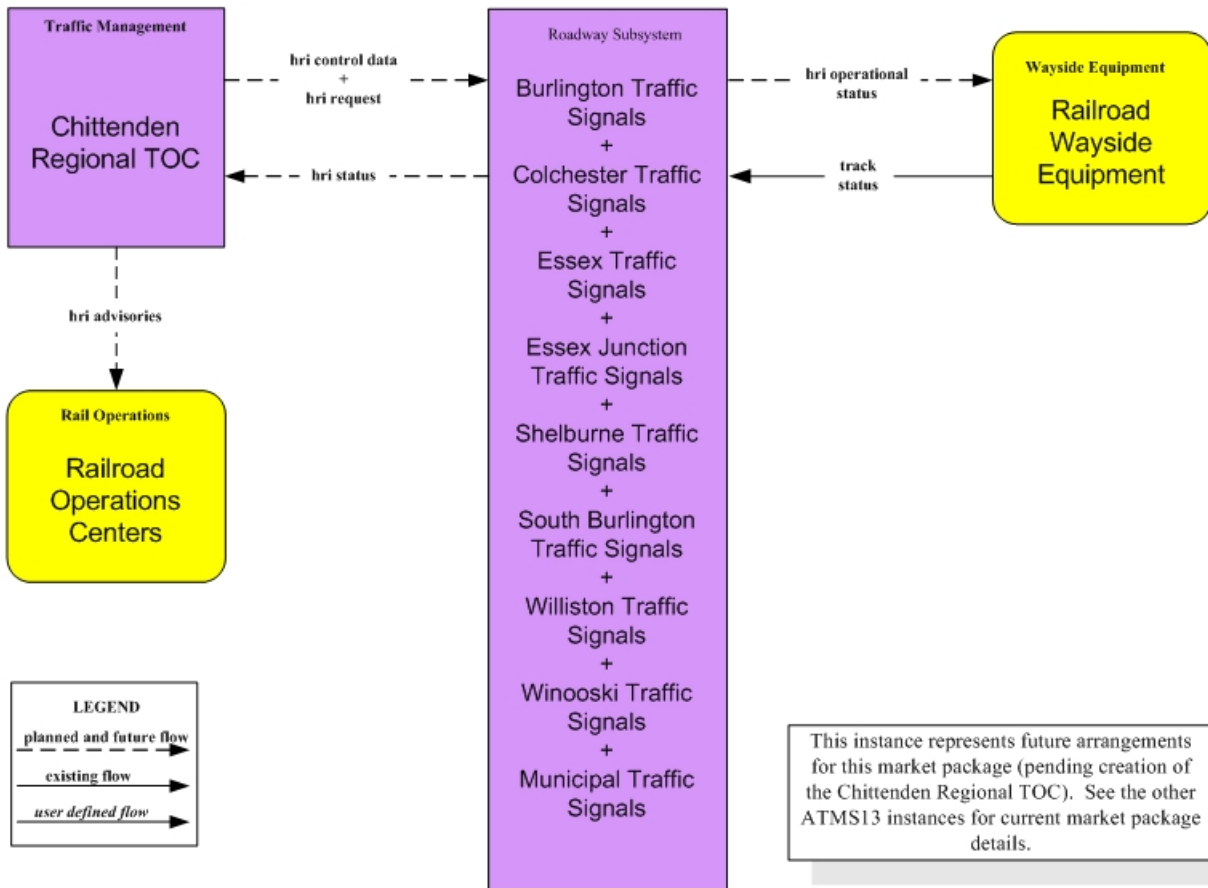



# ATMS15 – Railroad Operations Coordination

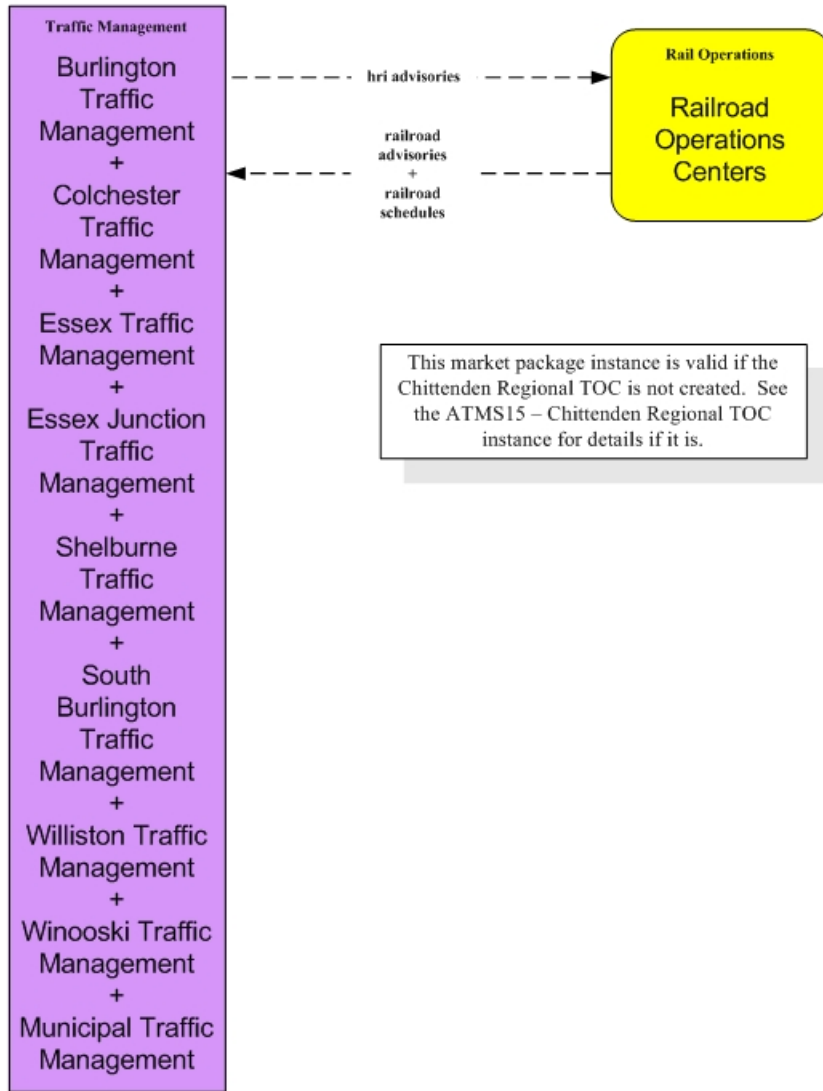

This market package instance is valid if the Chittenden Regional TOC is not created. See the ATMS15 – Chittenden Regional TOC instance for details if it is.

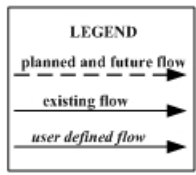

# ATMS16 - Parking Facility Management

## Burlington Parking Management

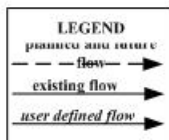
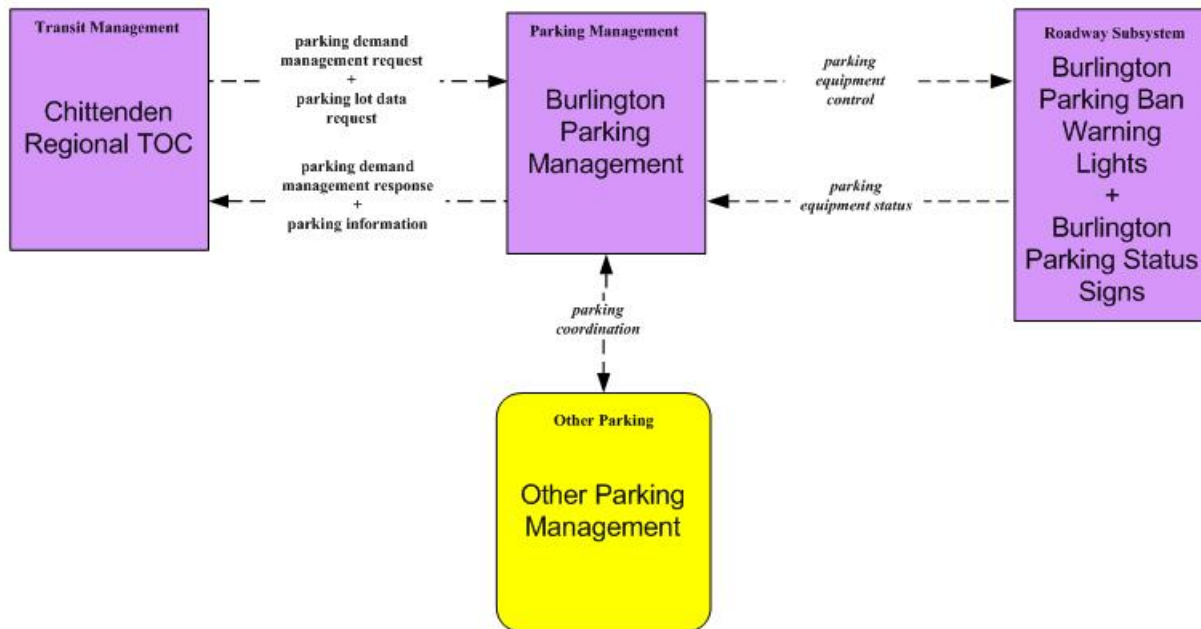

# EMO2 – Emergency Routing Burlington Traffic Management

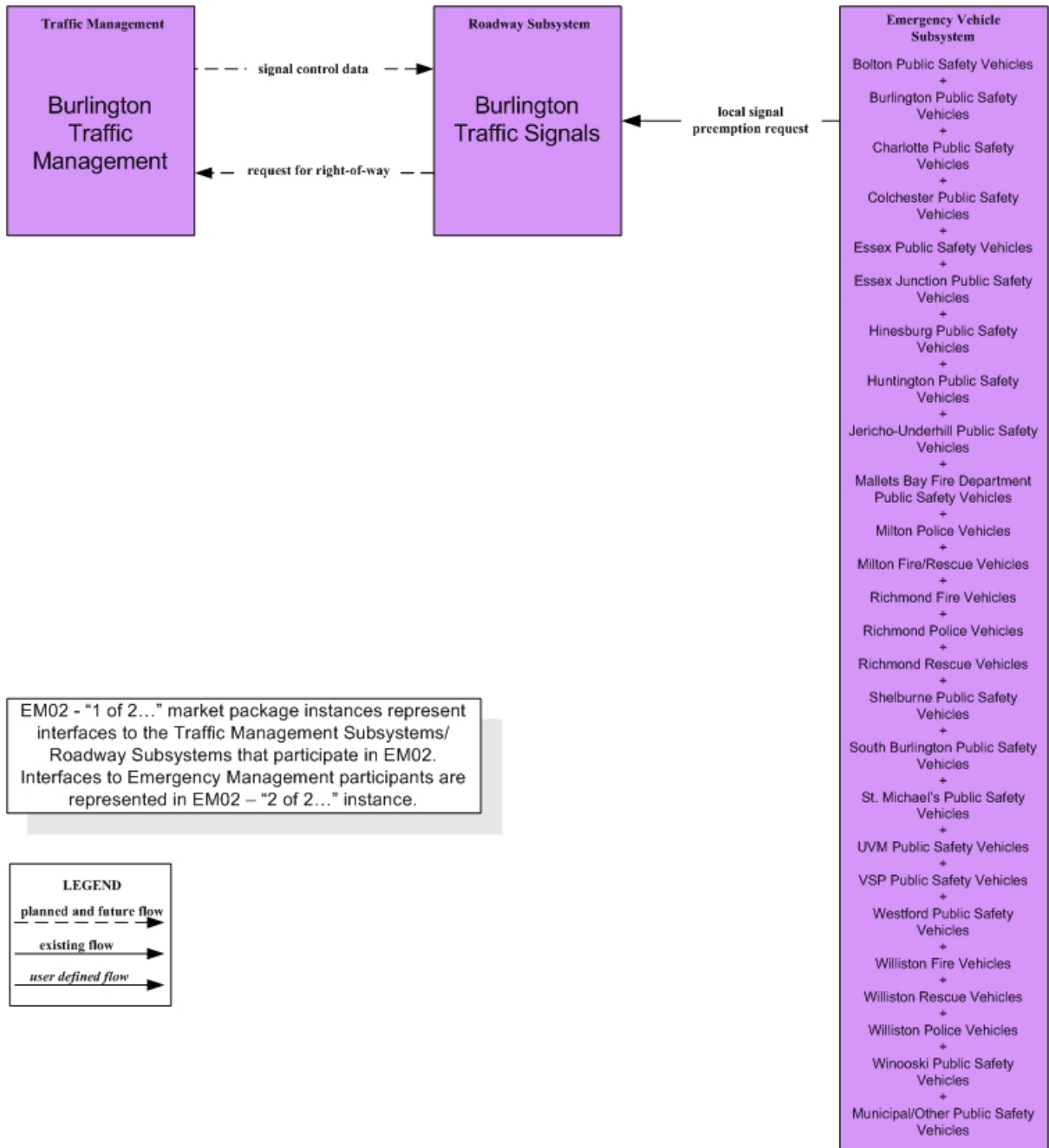

EMO2 – Emergency Routing  
1 of 2 - Chittenden Regional TOC

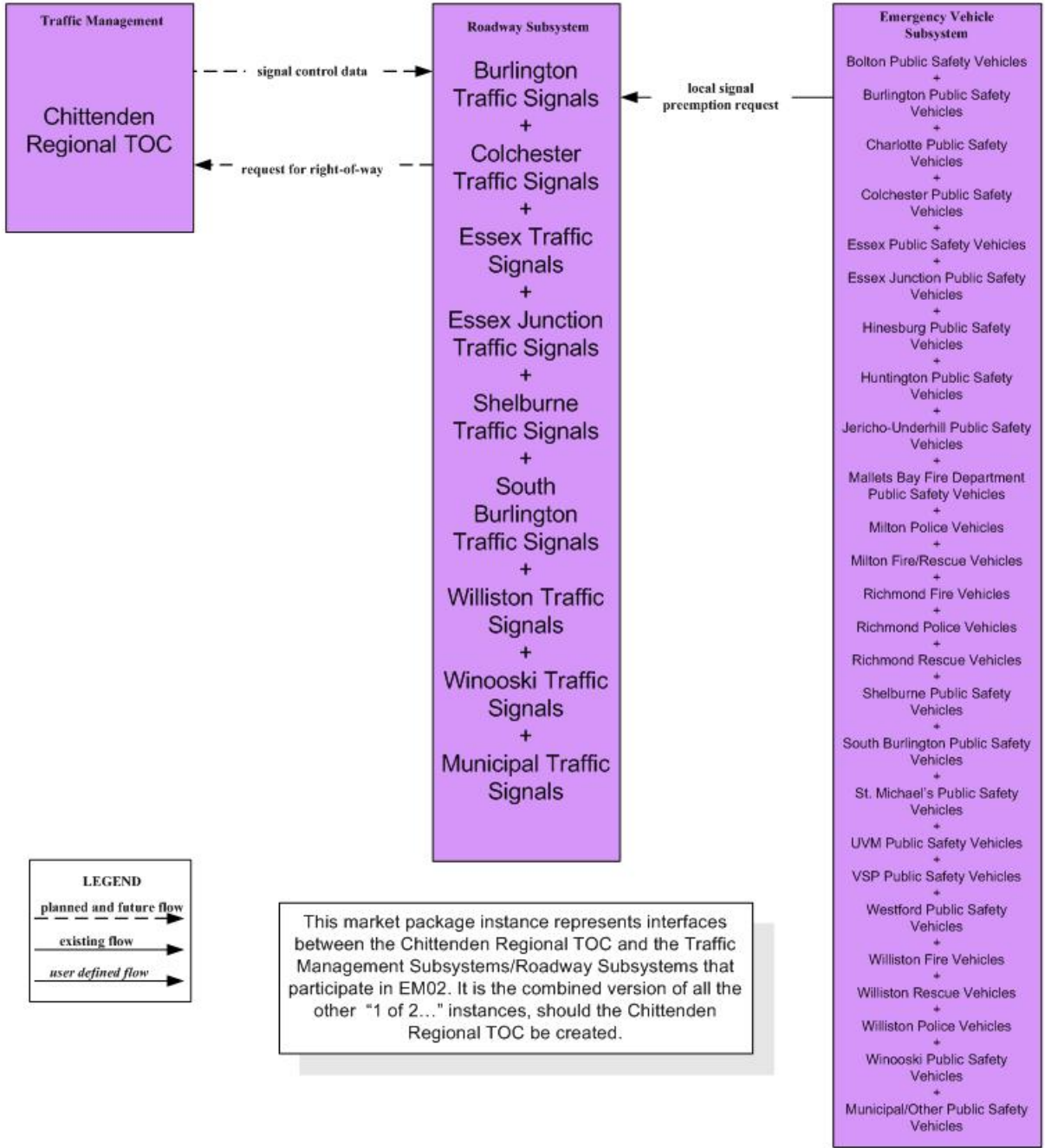

# EMO2 – Emergency Routing

## 2 of 2 – Emergency Management

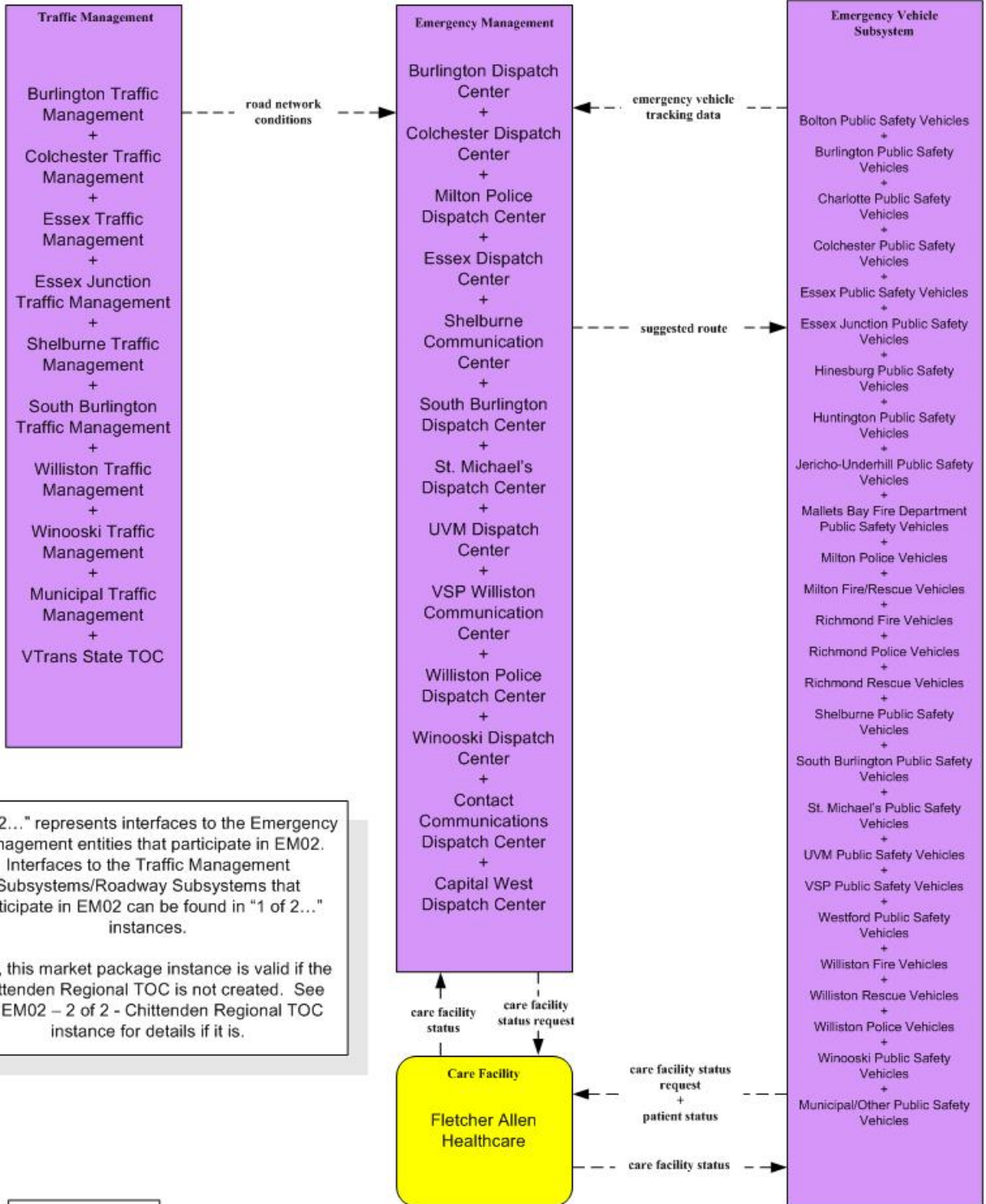

"2 of 2..." represents interfaces to the Emergency Management entities that participate in EM02. Interfaces to the Traffic Management Subsystems/Roadway Subsystems that participate in EM02 can be found in "1 of 2..." instances.

Also, this market package instance is valid if the Chittenden Regional TOC is not created. See the EM02 – 2 of 2 - Chittenden Regional TOC instance for details if it is.

**EMO6 – Wide Area Alert  
Vermont Statewide EOC & VSP Headquarters**

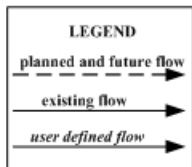
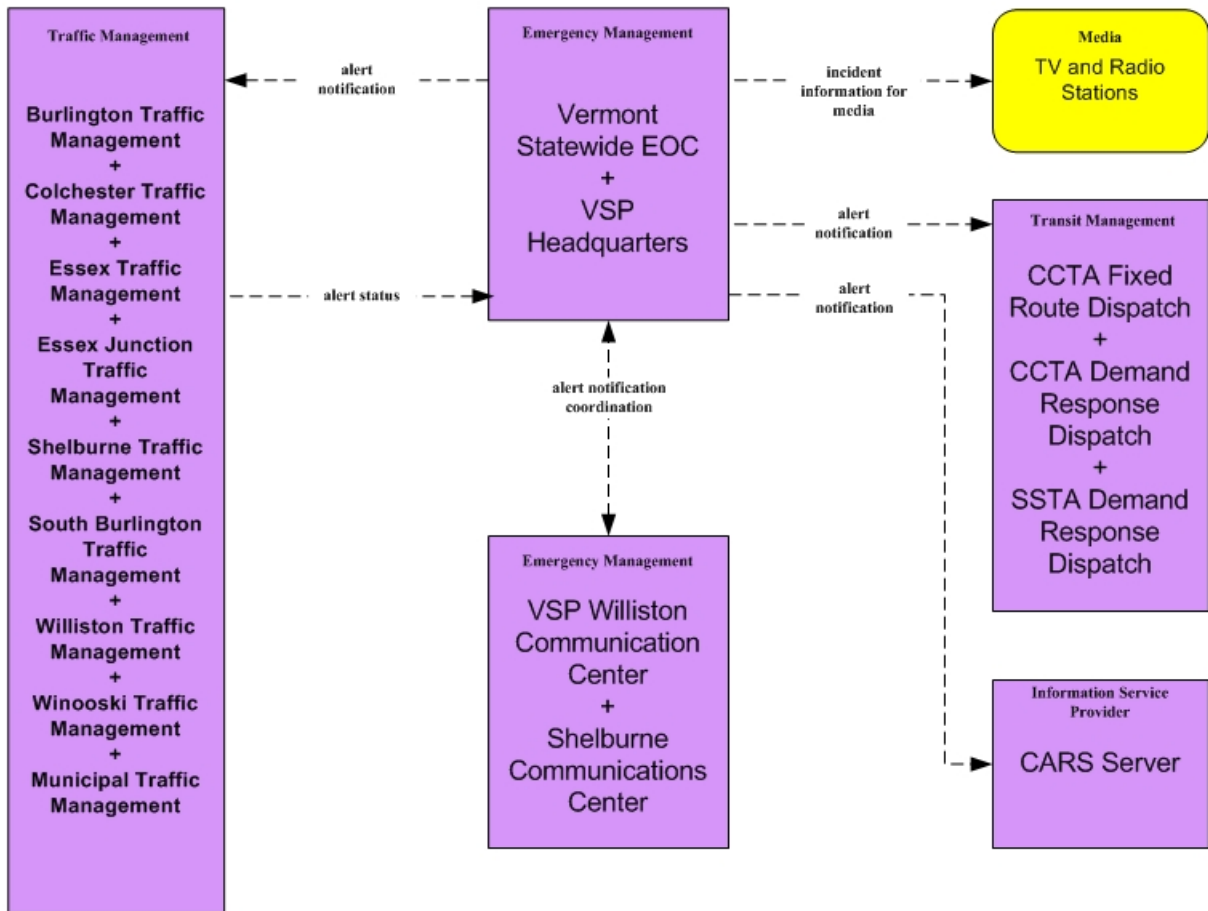

EM09 - Evacuation and Reentry Management  
Vermont Statewide EOC

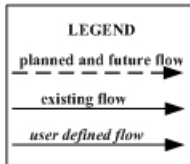
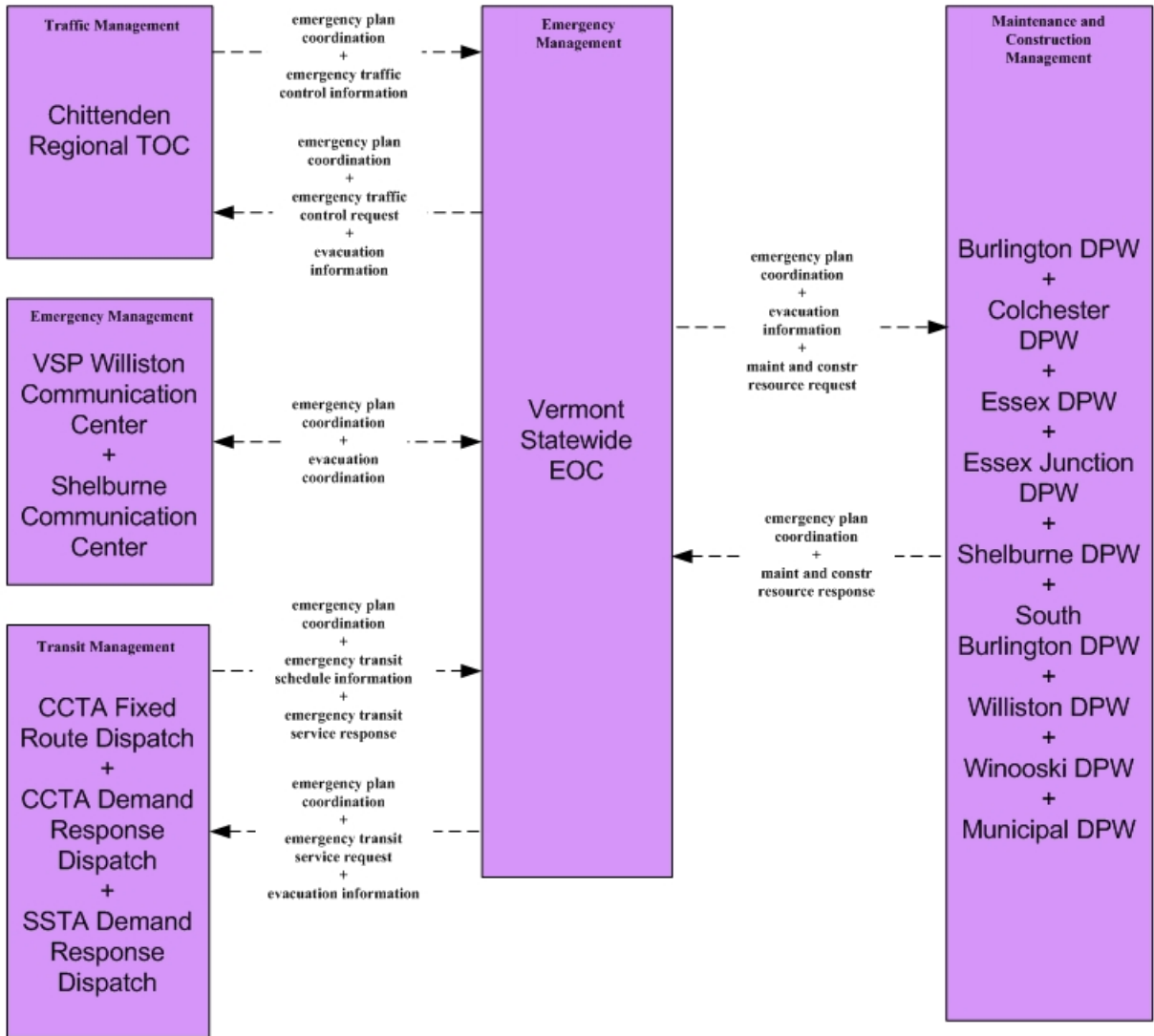

# MC01 – Maintenance and Construction Vehicle Tracking Burlington DPW

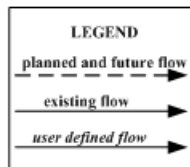
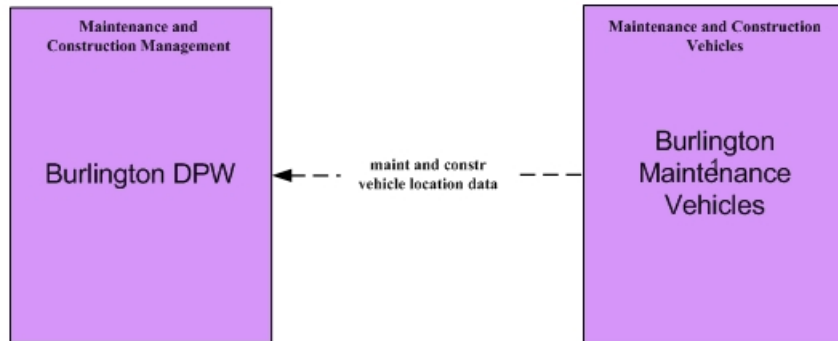



MC02 – Maintenance and Construction Vehicle Maintenance  
Burlington DPW

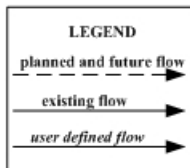
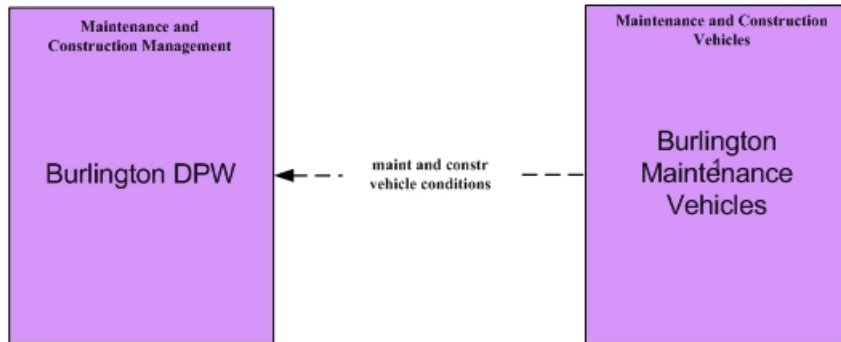

MC04 - Weather Information Processing and Distribution  
Weather Services

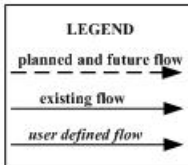
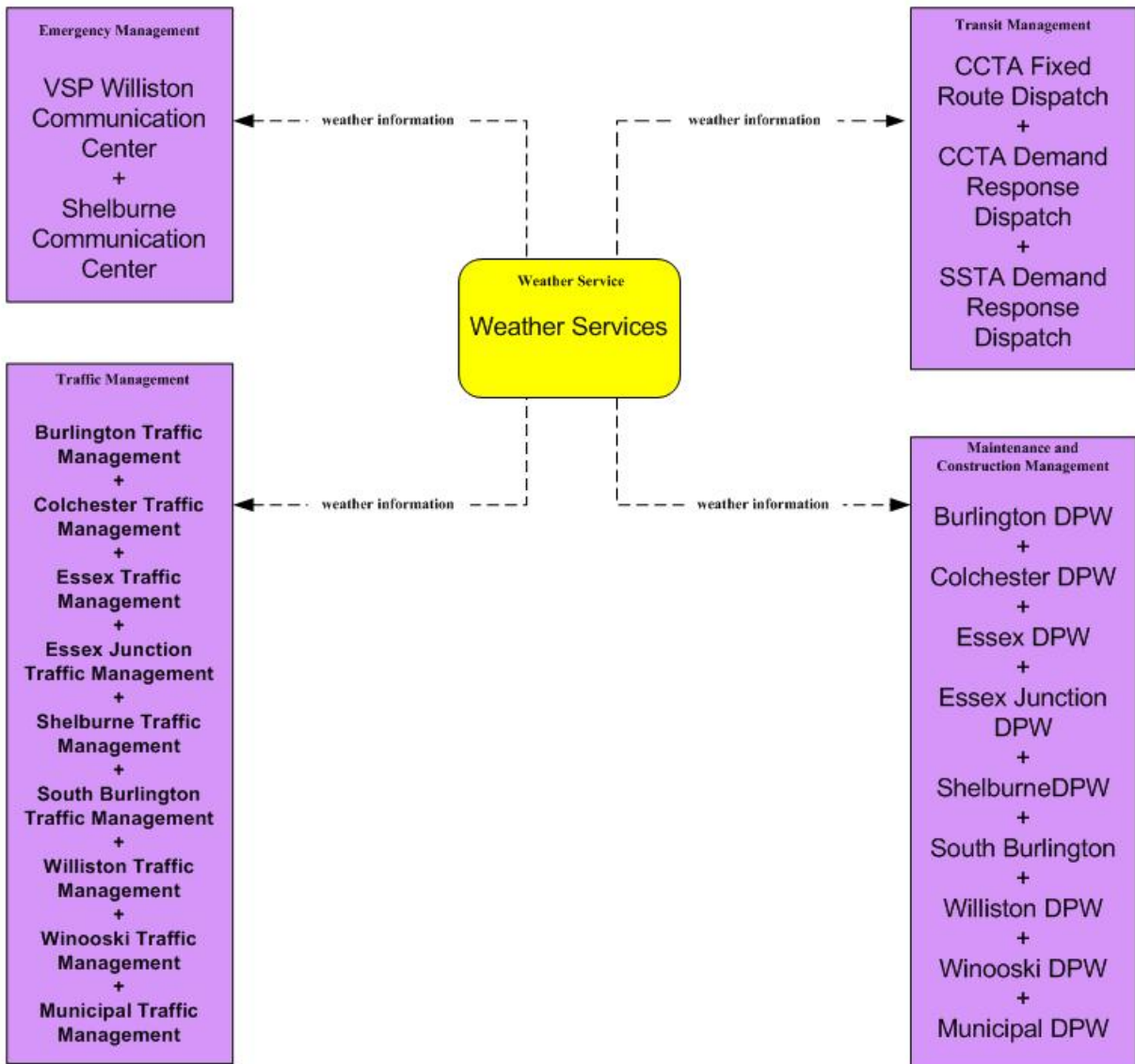

This instance represents the situation for this market package with existing entities only. See the MC04 – Weather Services (Chittenden Regional TOC) instance for market package details pending creation of the Chittenden Regional TOC.

MC04 - Weather Information Processing and Distribution  
Weather Services – Chittenden Regional TOC

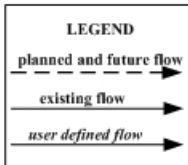
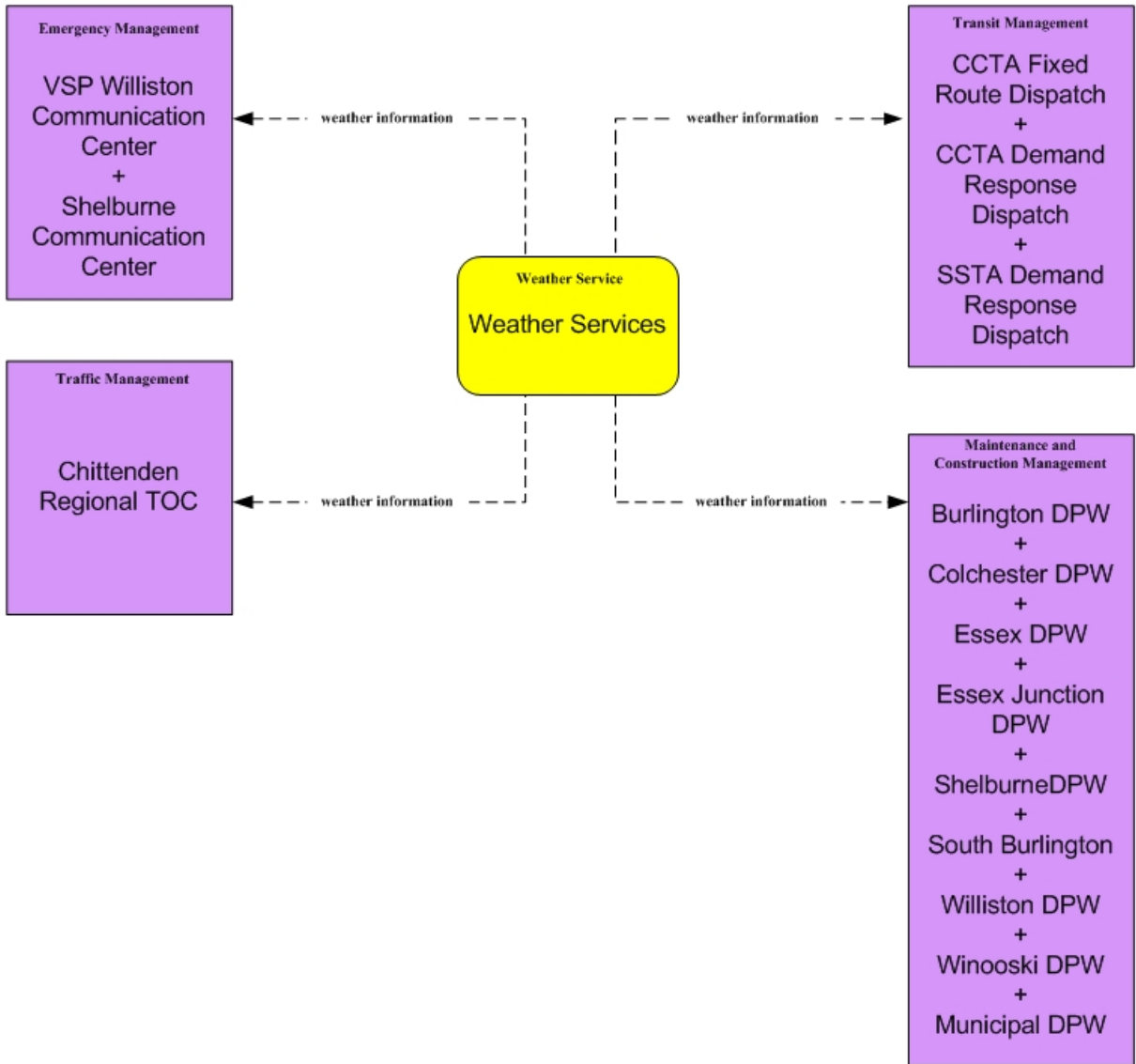

This instance represents the situation for this market package pending creation of the Chittenden Regional TOC. See the MC04 – Weather Services instance for market package details with existing entities only.

MC06 - Winter Maintenance  
Burlington DPW

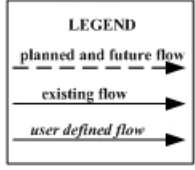
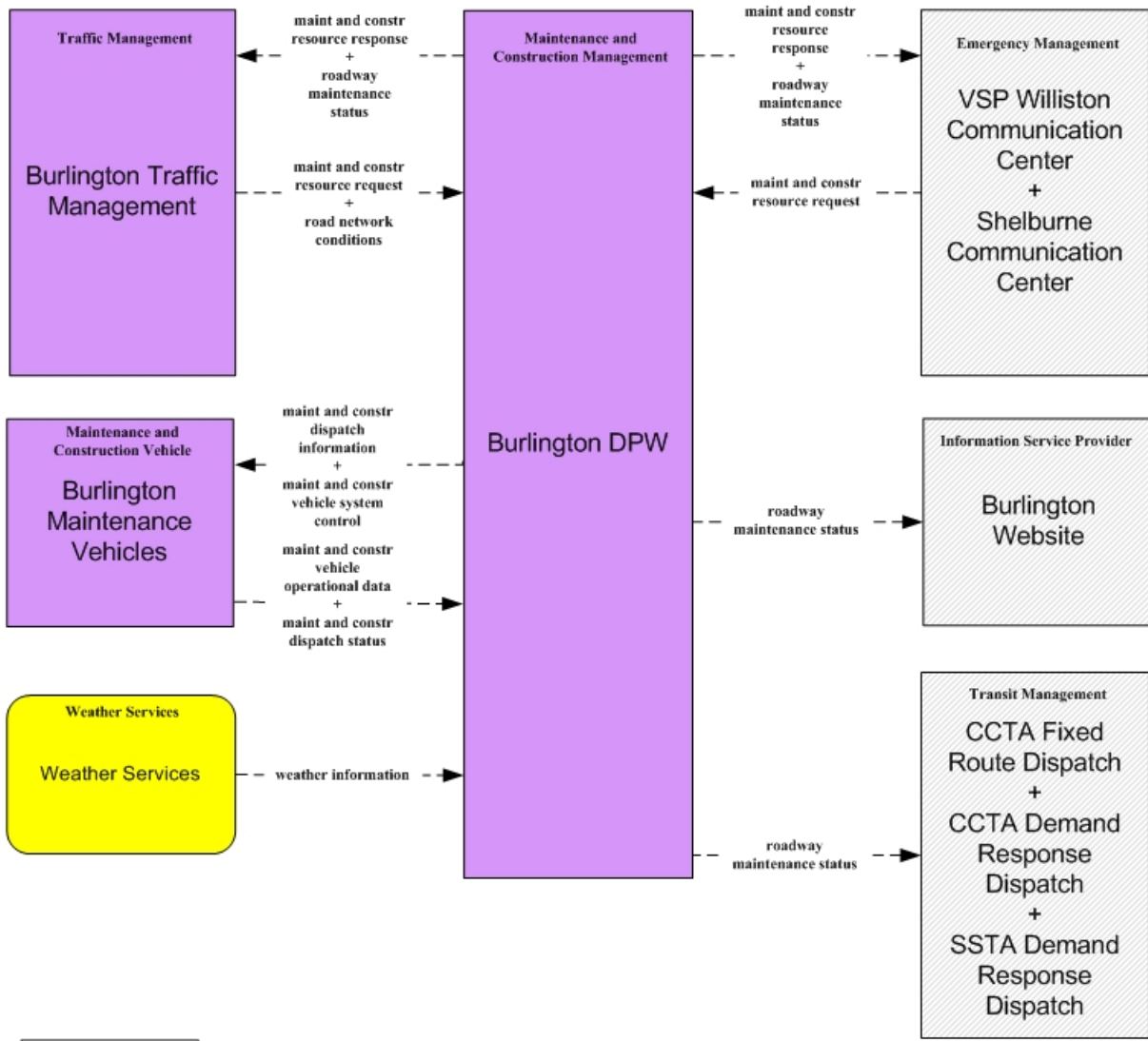

# MC07 - Roadway Maintenance and Construction Burlington DPW

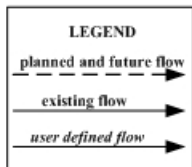
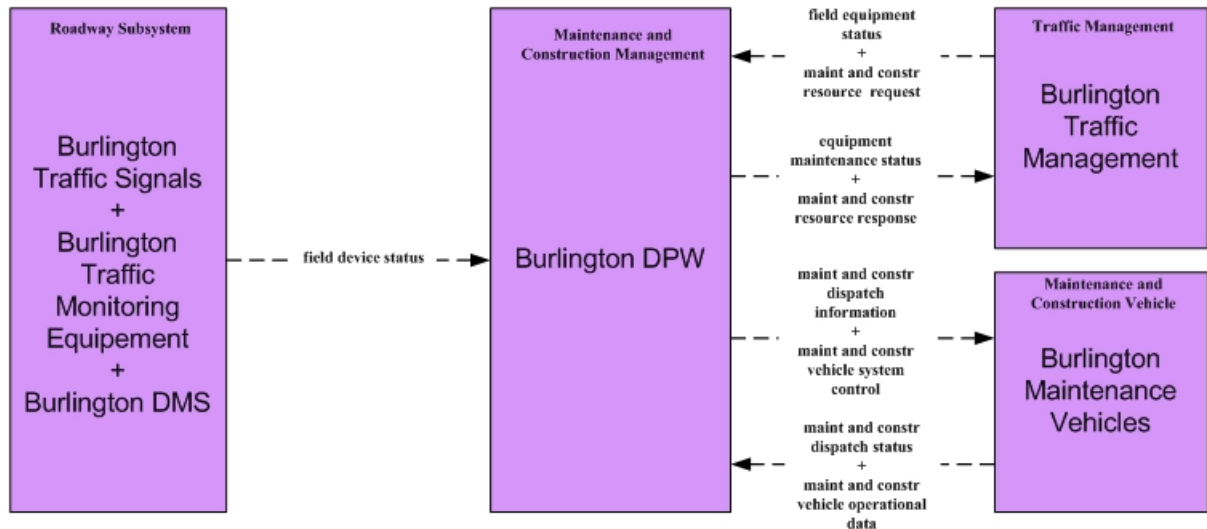

MC08 - Work Zone Management  
Burlington DPW

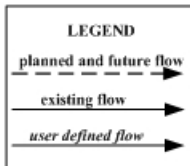
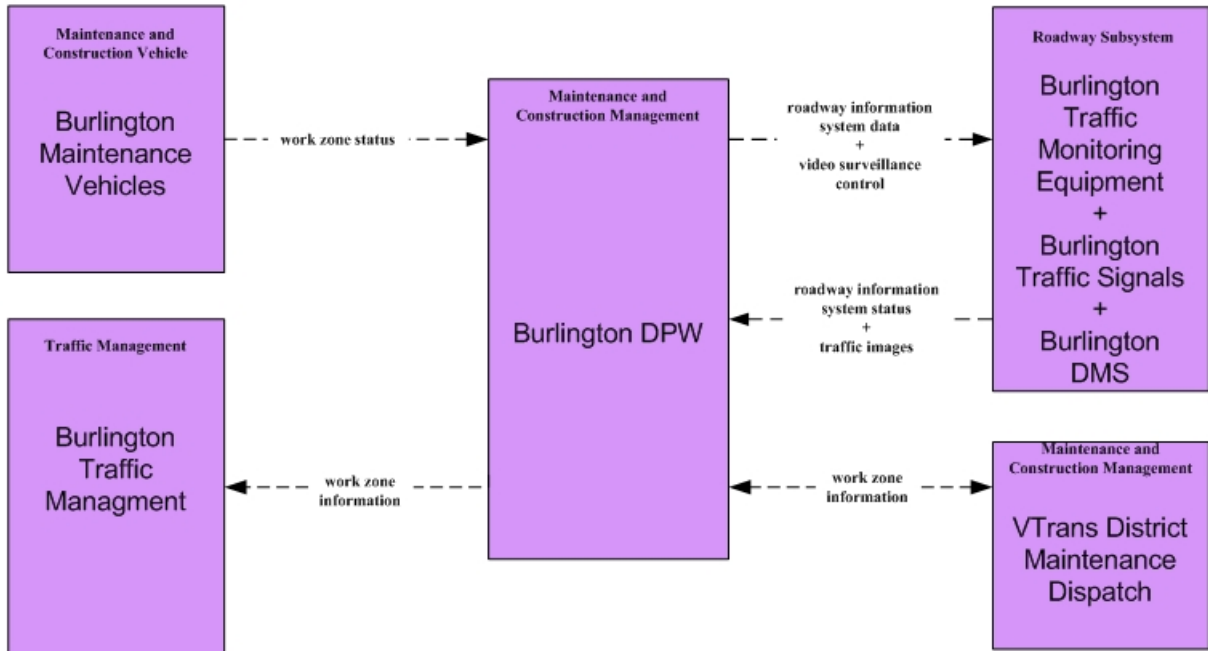

MC08 - Work Zone Management  
VTrans District Maintenance Dispatch

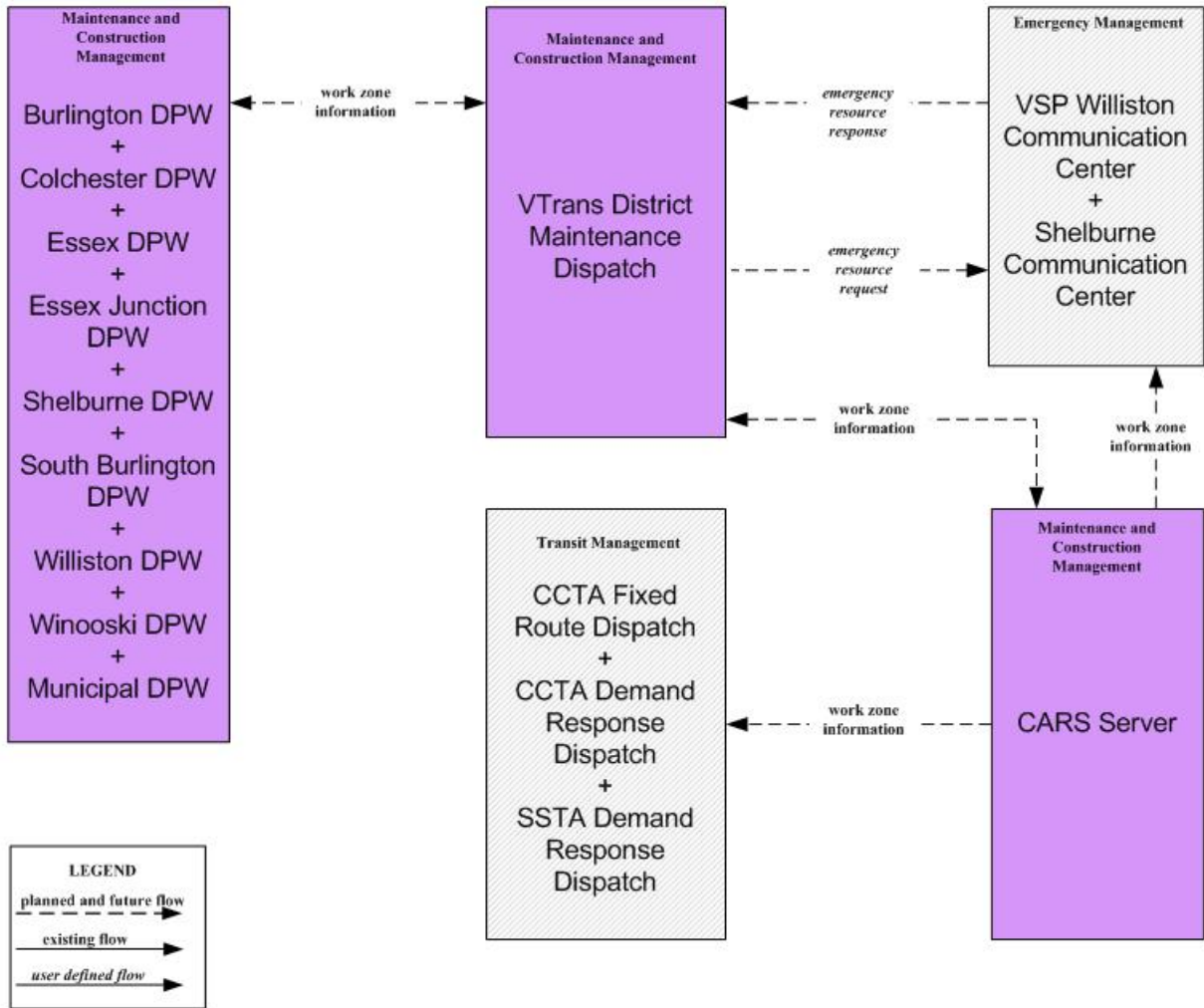

MC10 – Maintenance and Construction Activity Coordination  
Burlington DPW

