

AD1 - ITS Data Mart
CCTA Data Repository

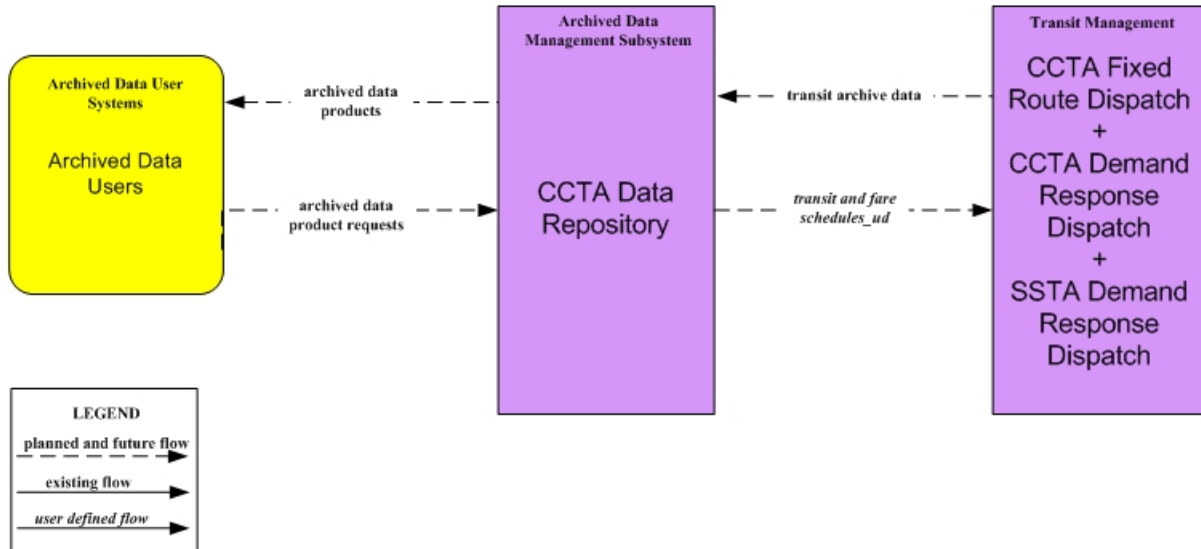

AD2 - ITS Data Warehouse
CCMPO Data Warehouse

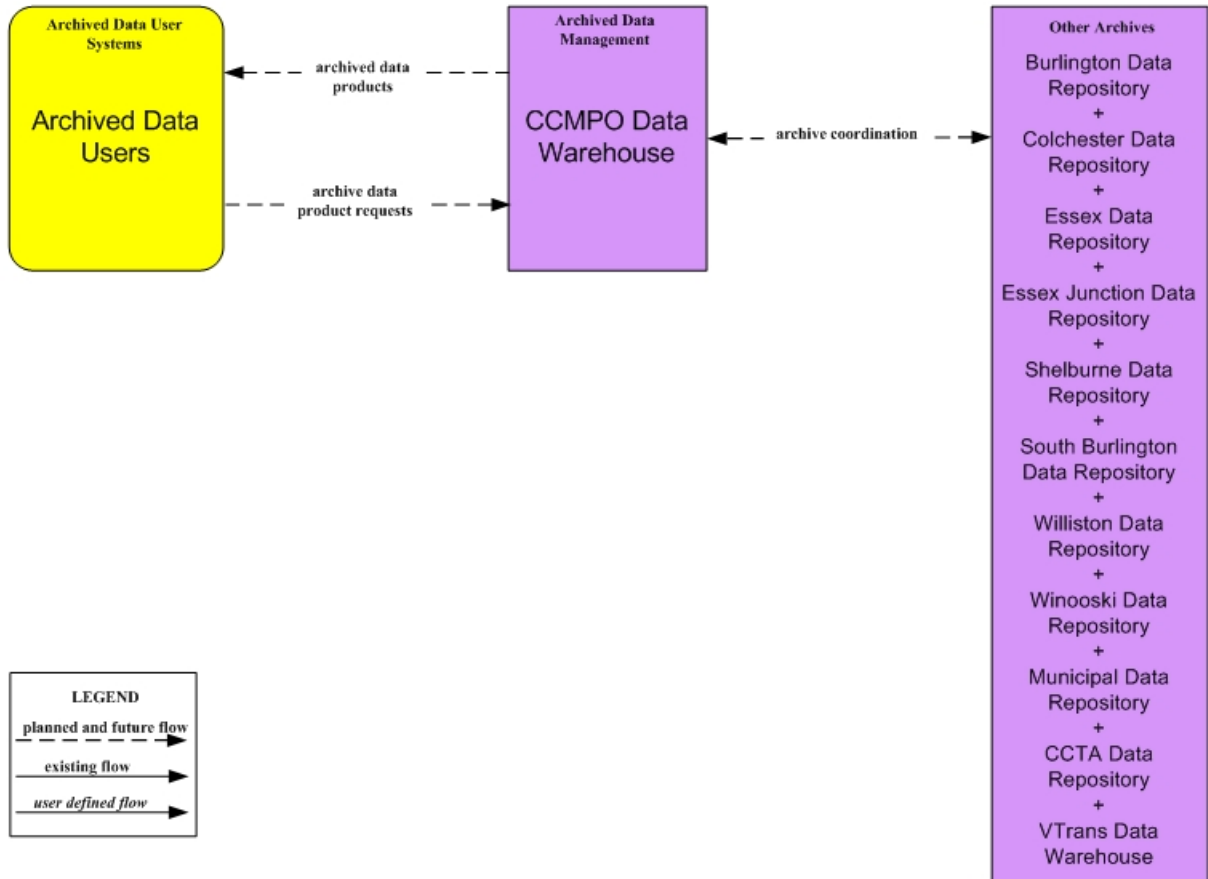

APTS1 - Transit Vehicle Tracking CCTA

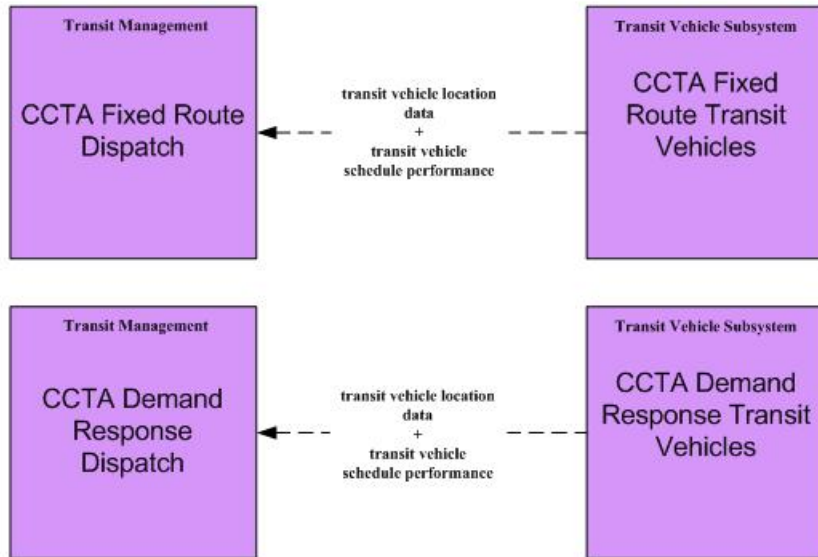

LEGEND

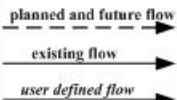

APTS2 - Transit Fixed-Route Operations CCTA

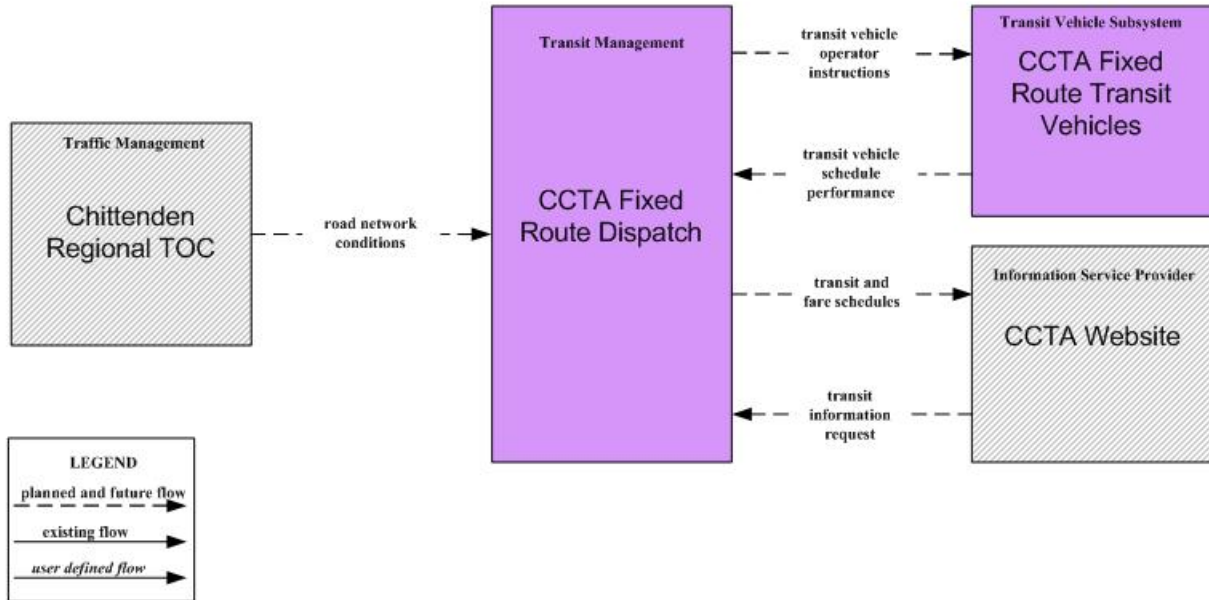

APTS3 - Demand Response Transit Operations CCTA

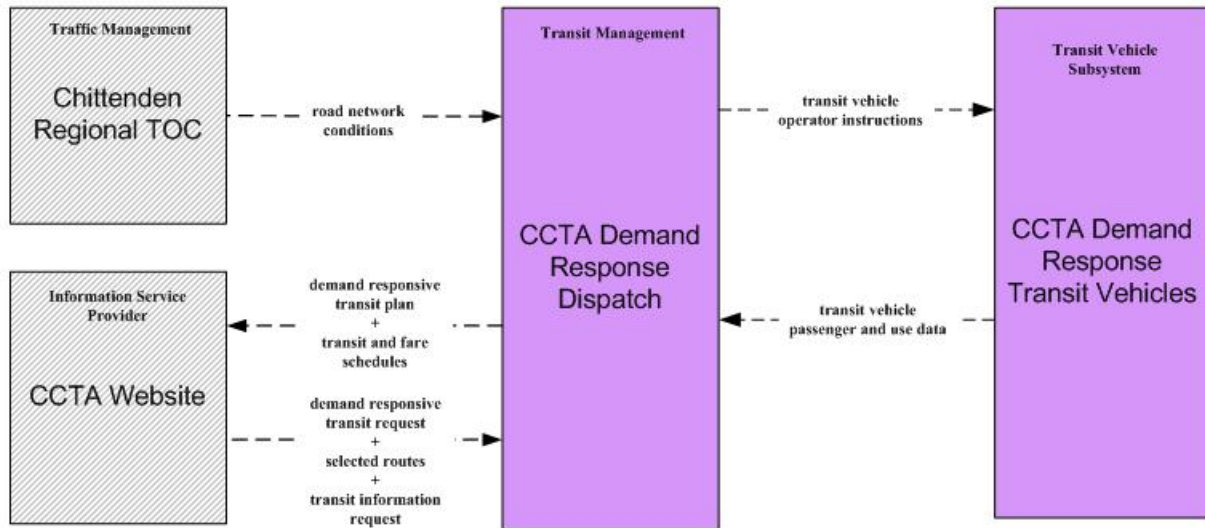

LEGEND

planned and future flow

existing flow

user defined flow

APTS3 - Demand Response Transit Operations SSTA

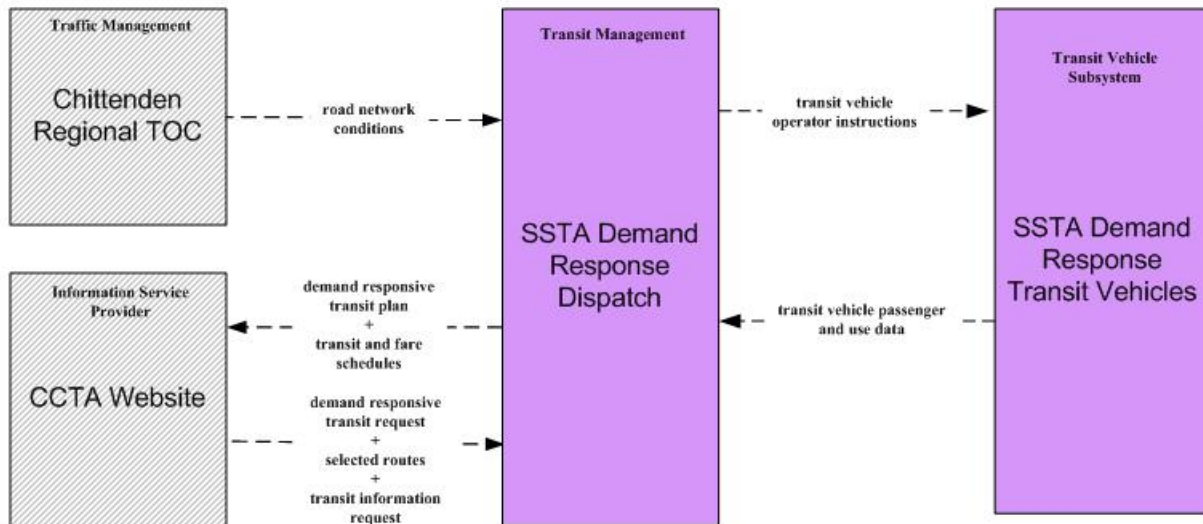

LEGEND

planned and future flow →

existing flow →

user defined flow →

APTS4 - Transit Passenger and Fare Management
CCTA

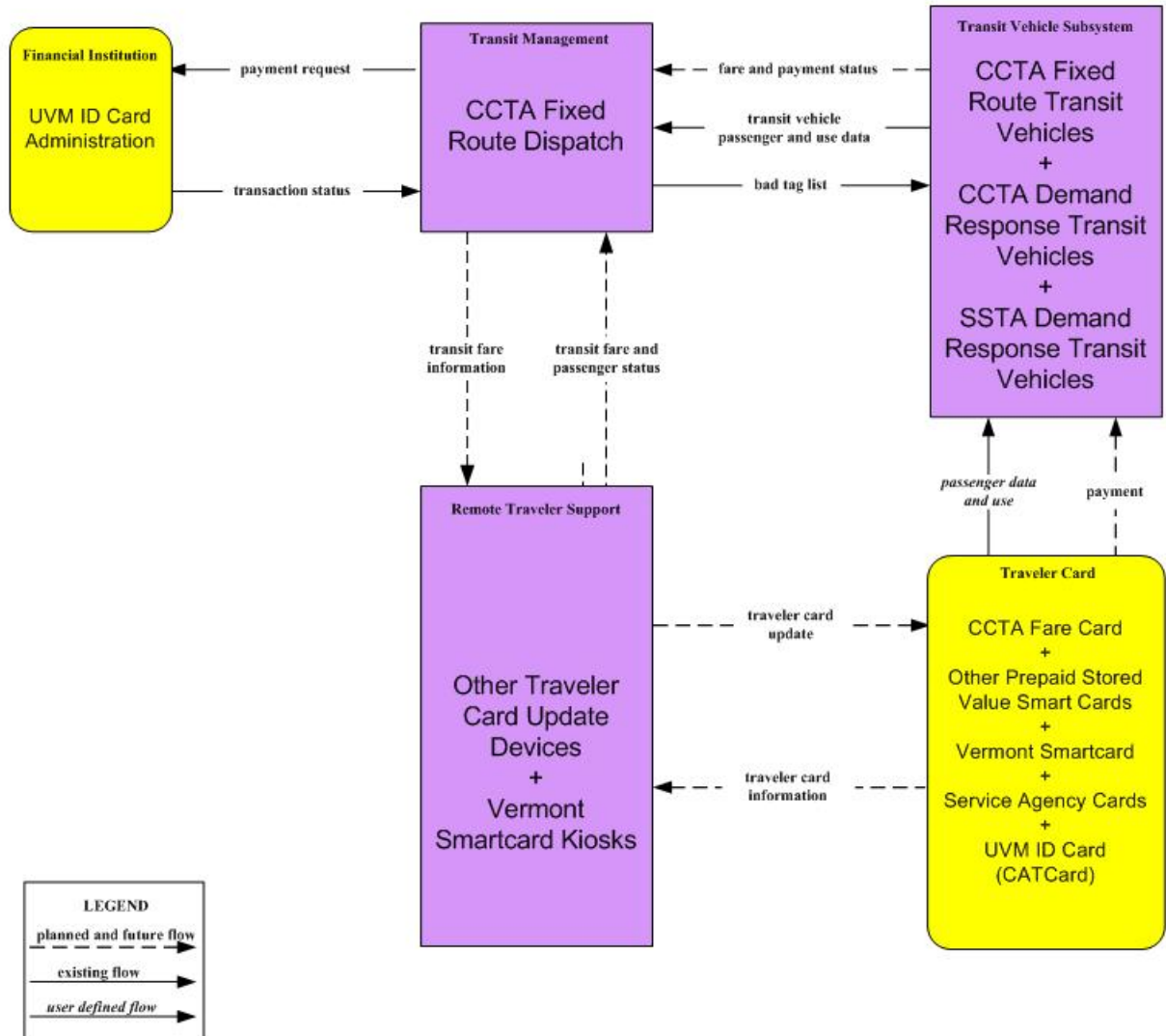

APTS5 - Transit Security

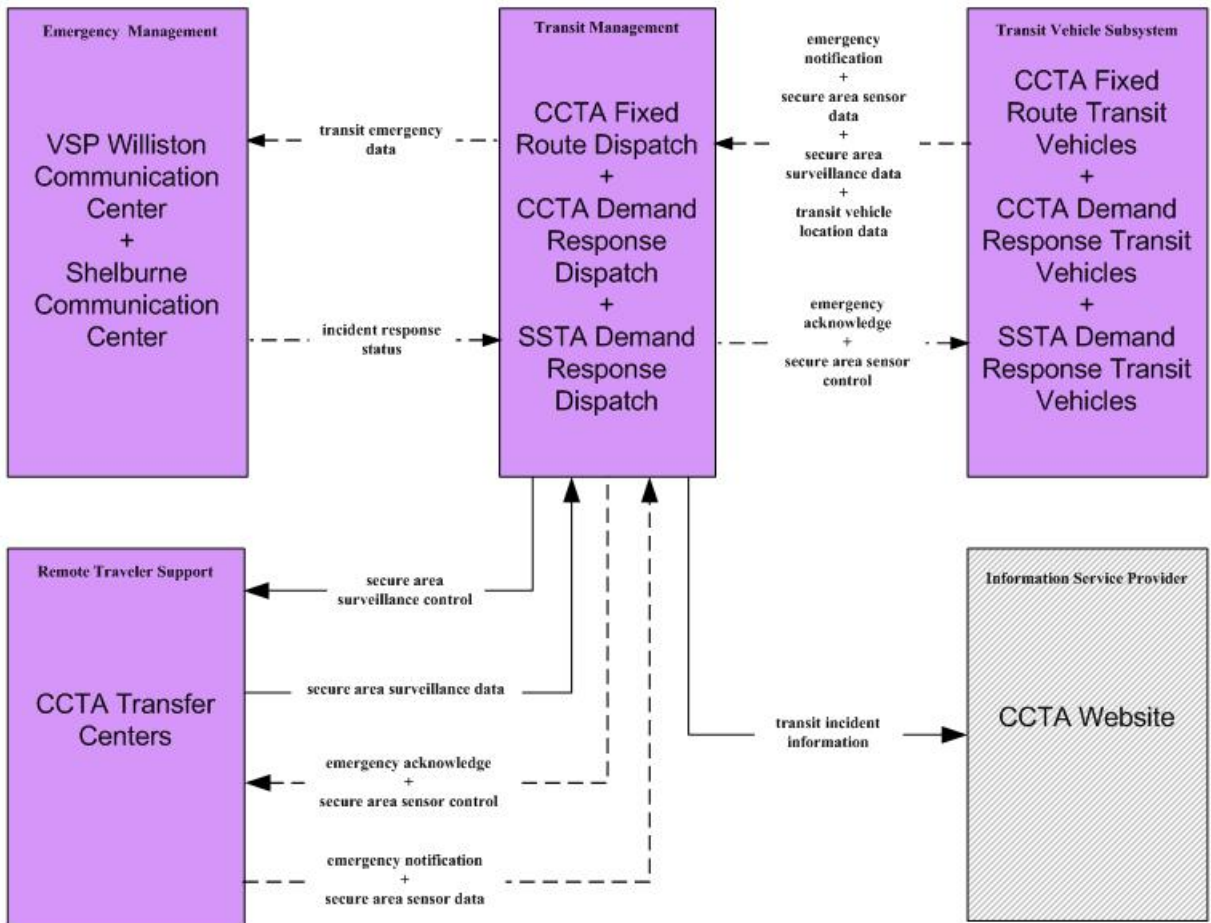

LEGEND

planned and future flow

existing flow

user defined flow

APTS6 - Transit Maintenance
CCTA

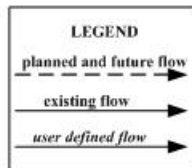
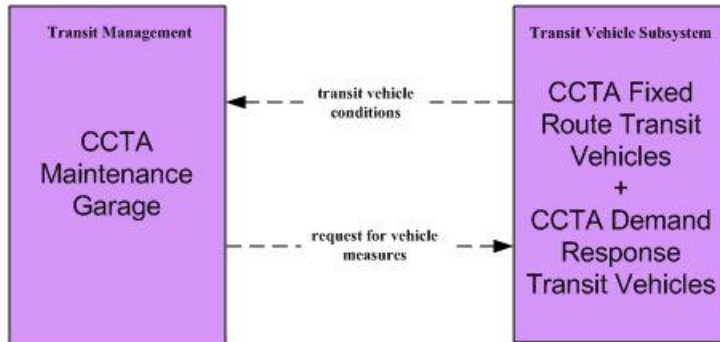

APTS7 – Multimodal Coordination
CCTA Fixed Route Dispatch

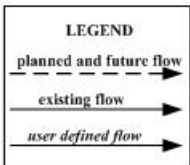
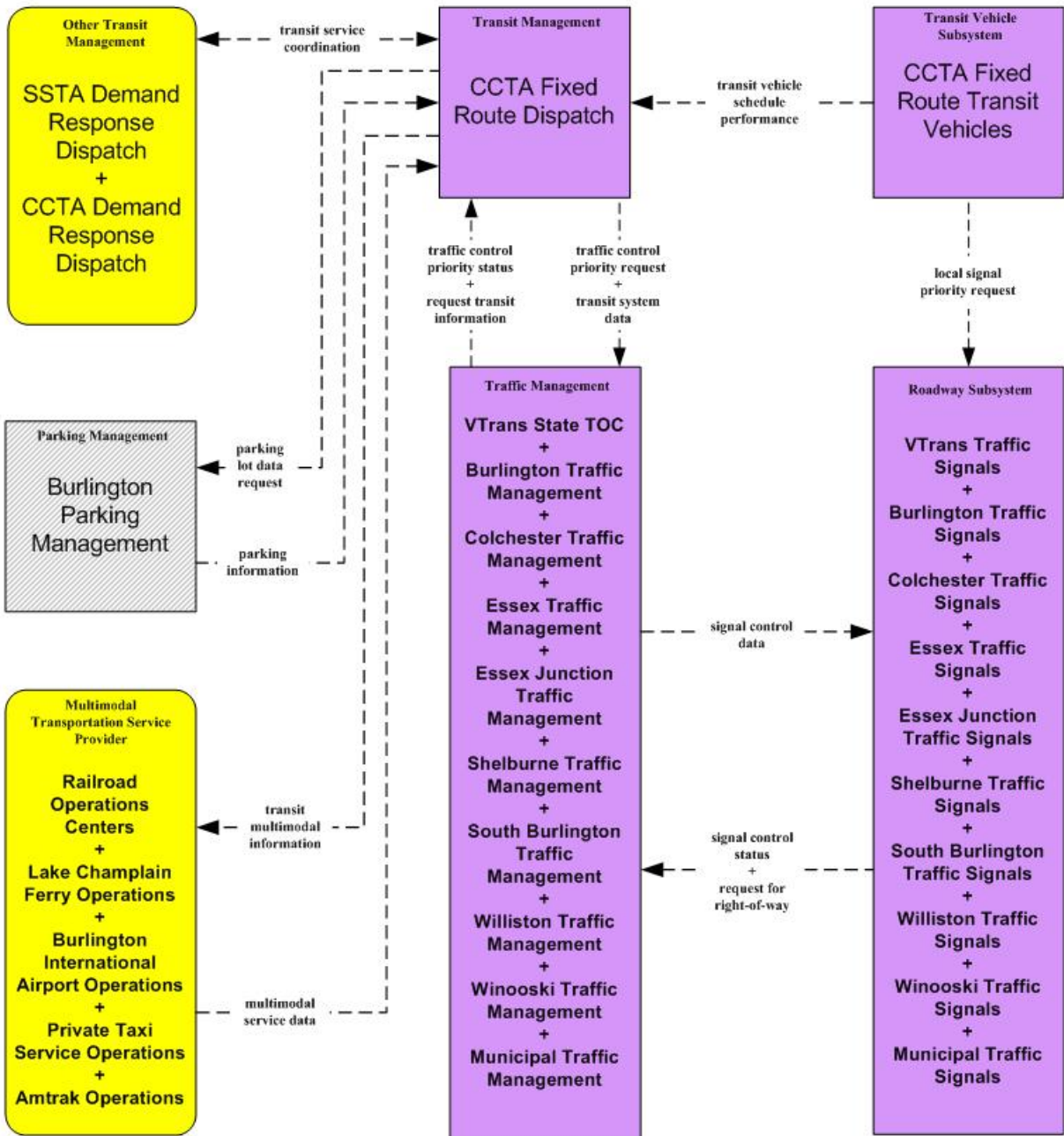

This market package instance is valid if the Chittenden Regional TOC is not created. See the APTS7 – Chittenden Regional TOC instance for details if it is.

APTS8 - Transit Traveler Information

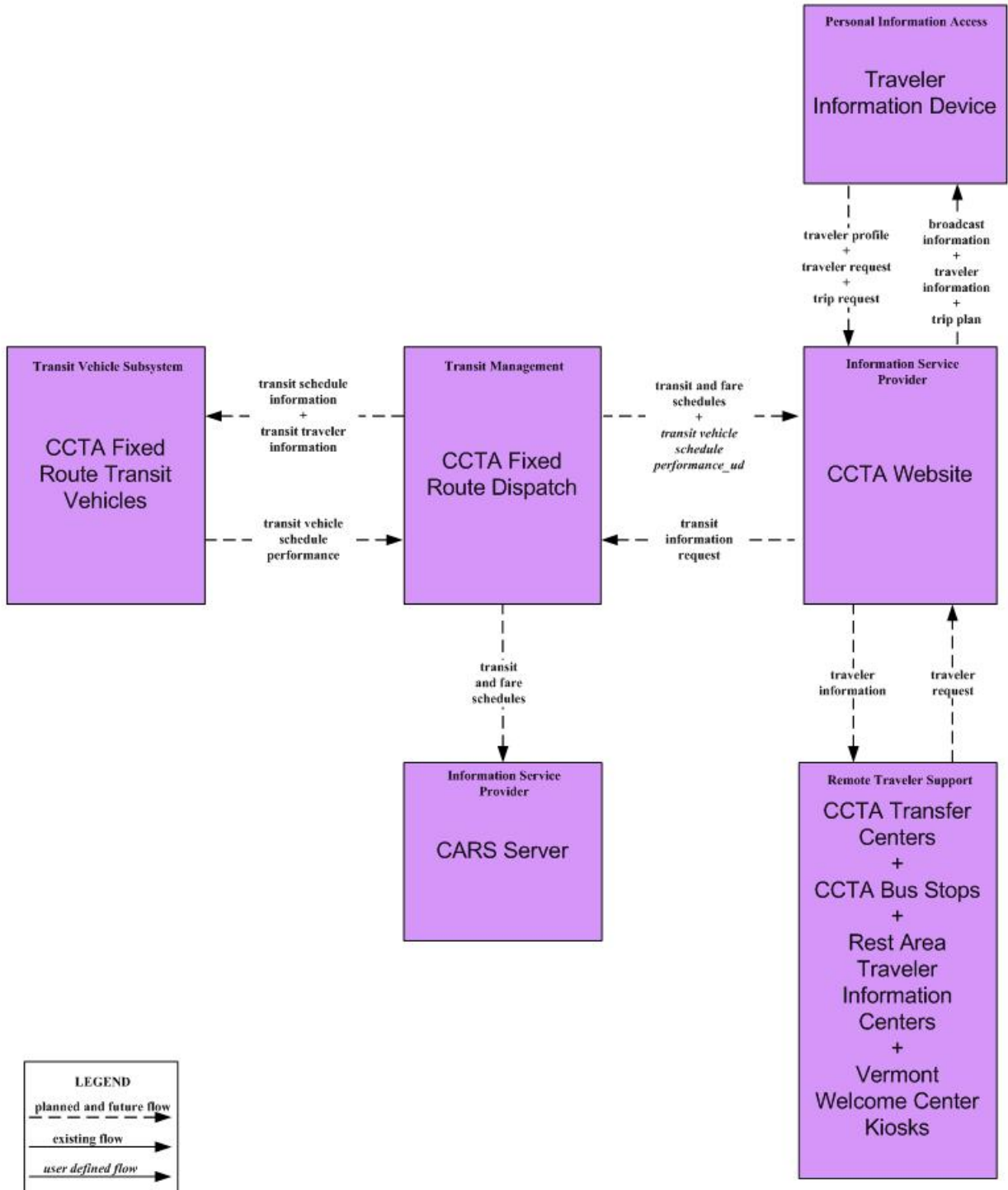

ATIS1 - Broadcast Traveler Information CARS Information System

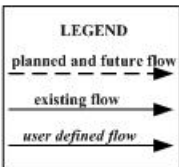
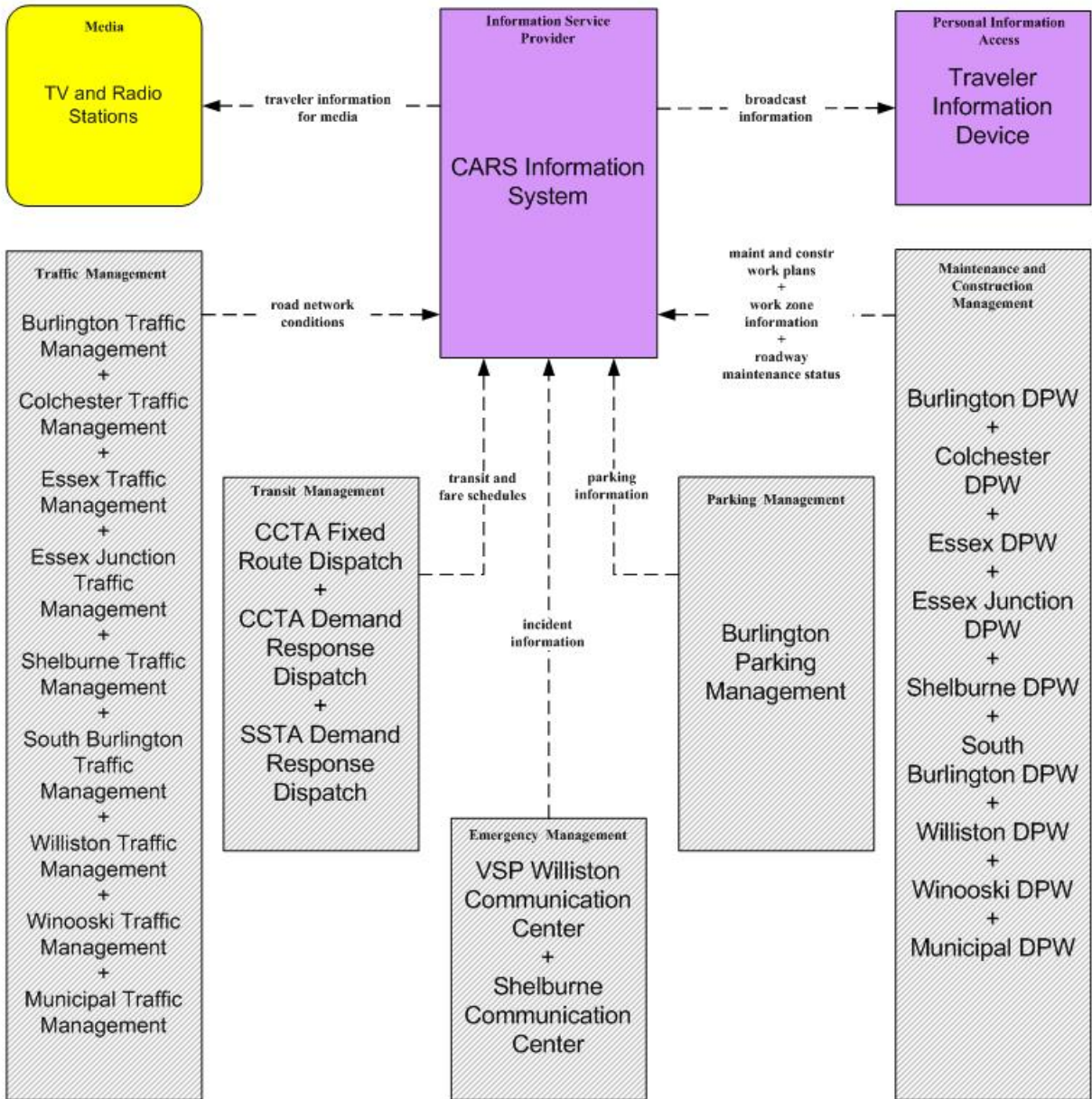

This market package instance is valid if the Chittenden Regional TOC is not created. See the ATIS1 – CARS – Chittenden Regional TOC instance for details if it is.

ATIS1 - Broadcast Traveler Information
 CARS Information System – Chittenden Regional TOC

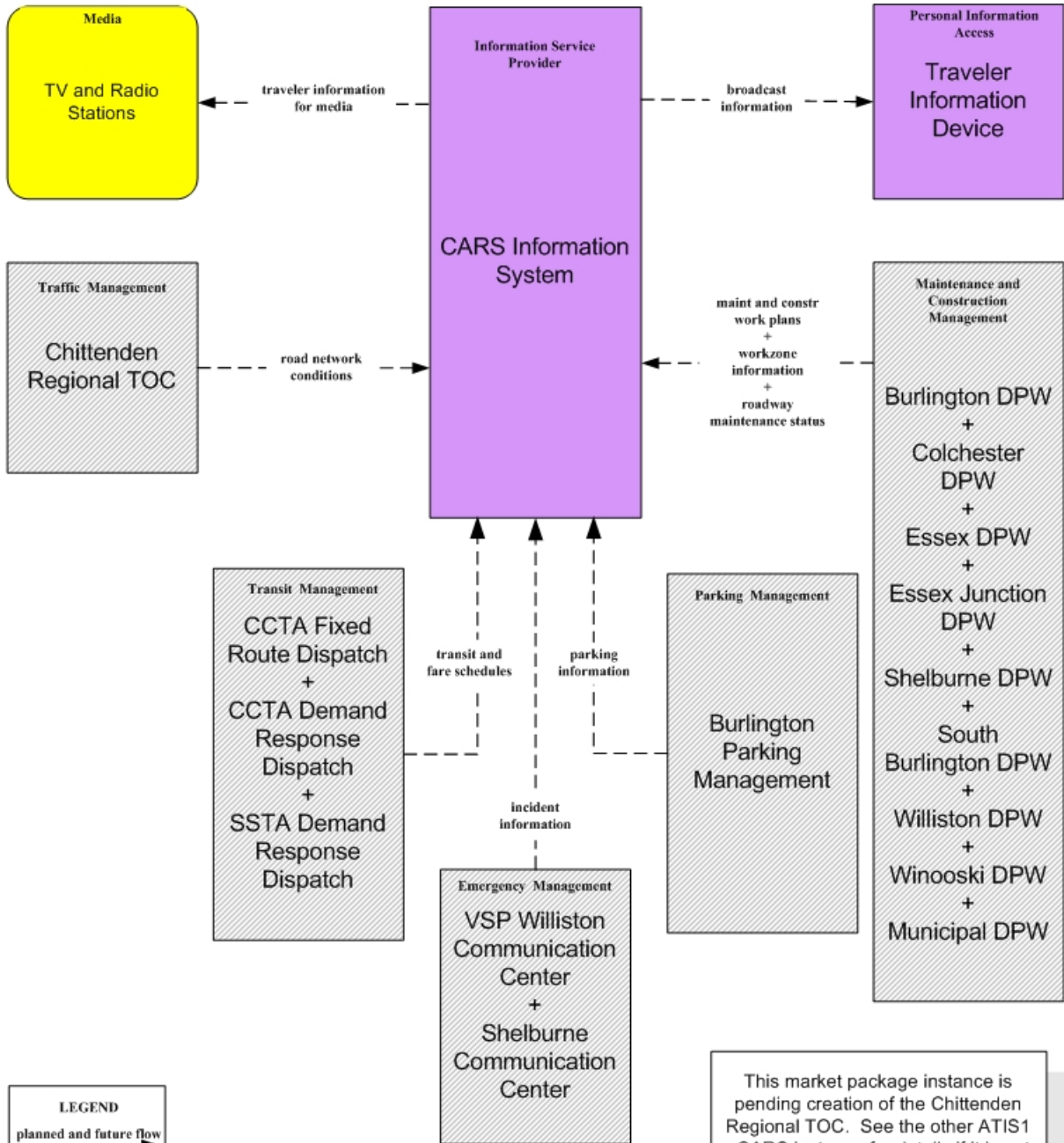

LEGEND

planned and future flow →

existing flow →

user defined flow →

This market package instance is pending creation of the Chittenden Regional TOC. See the other ATIS1 – CARS instance for details if it is not.

ATMS06 – Traffic Information Dissemination
Burlington Traffic Management

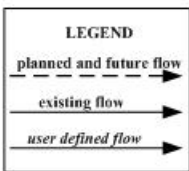
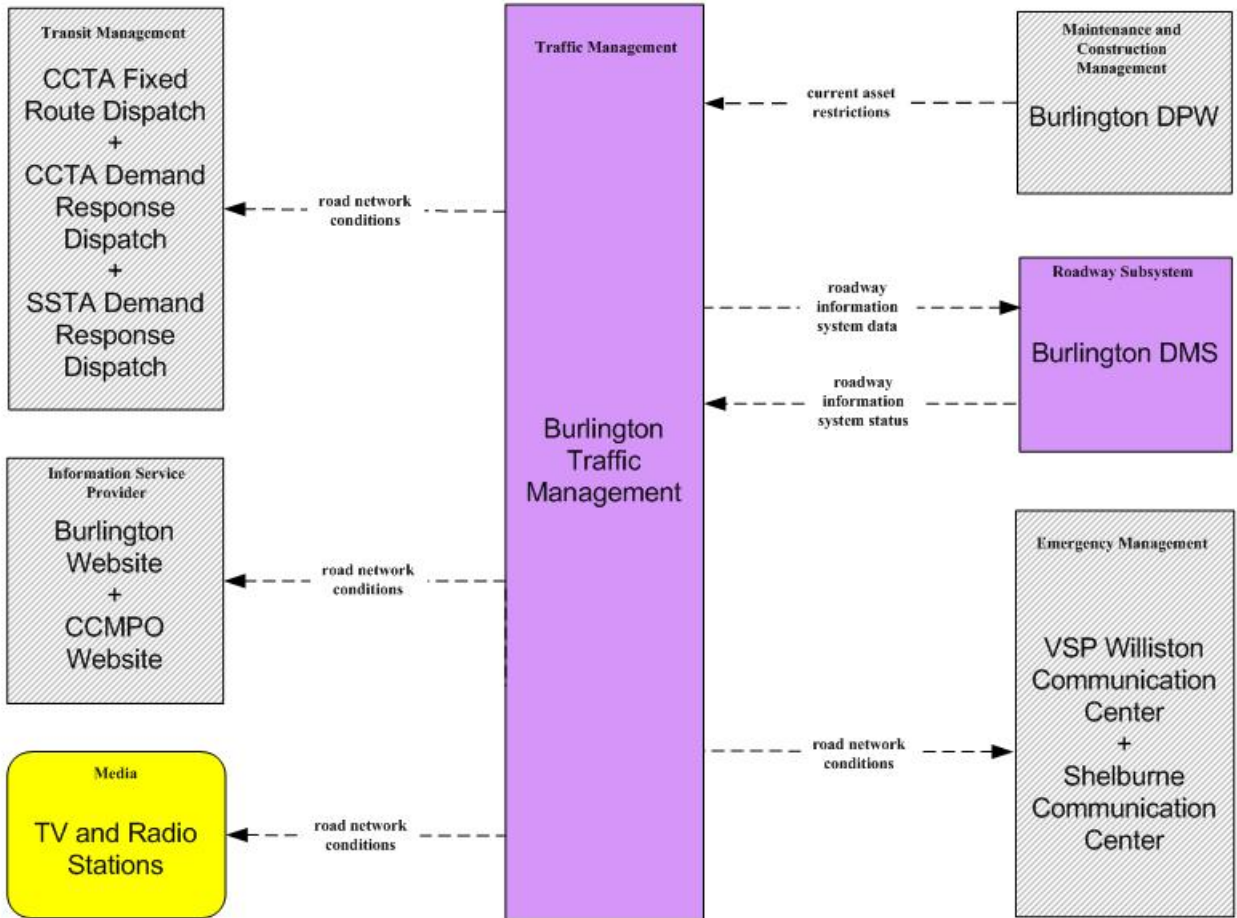

ATMS06 – Traffic Information Dissemination Colchester Traffic Management

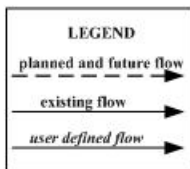
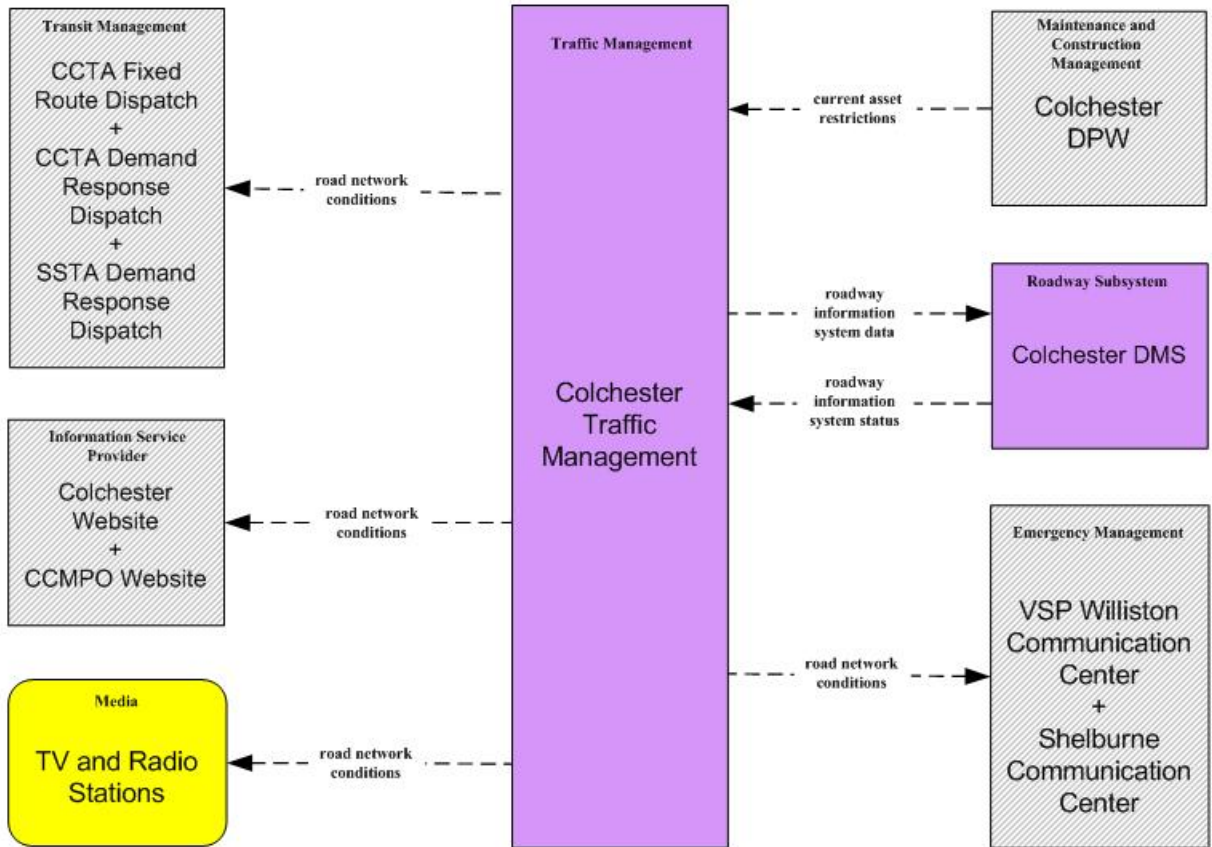

ATMS06 – Traffic Information Dissemination Chittenden Regional TOC (Future)

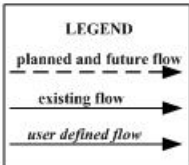
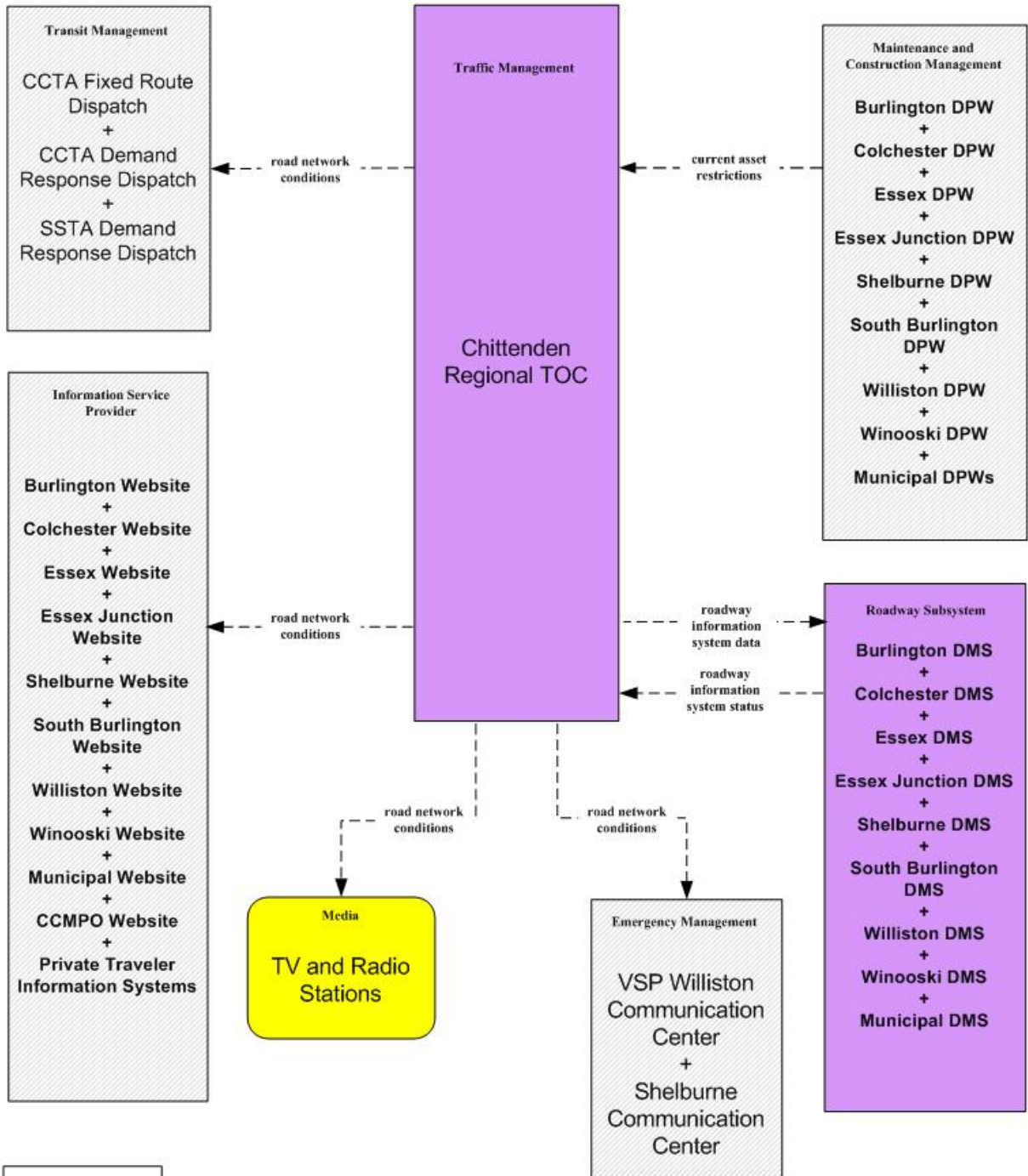

ATMS06 – Traffic Information Dissemination
Essex Traffic Management

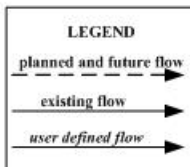
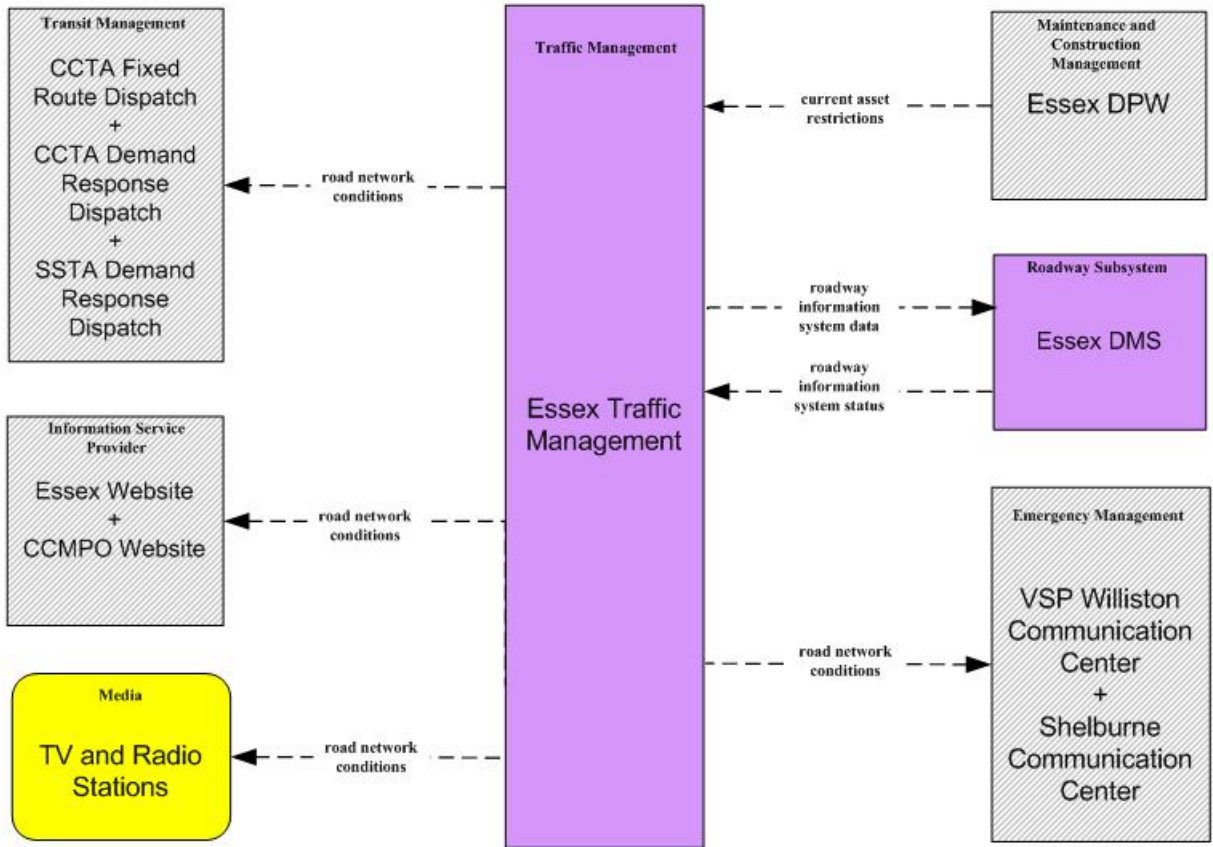

ATMS06 – Traffic Information Dissemination
Essex Junction Traffic Management

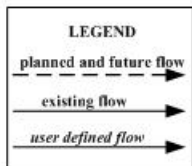
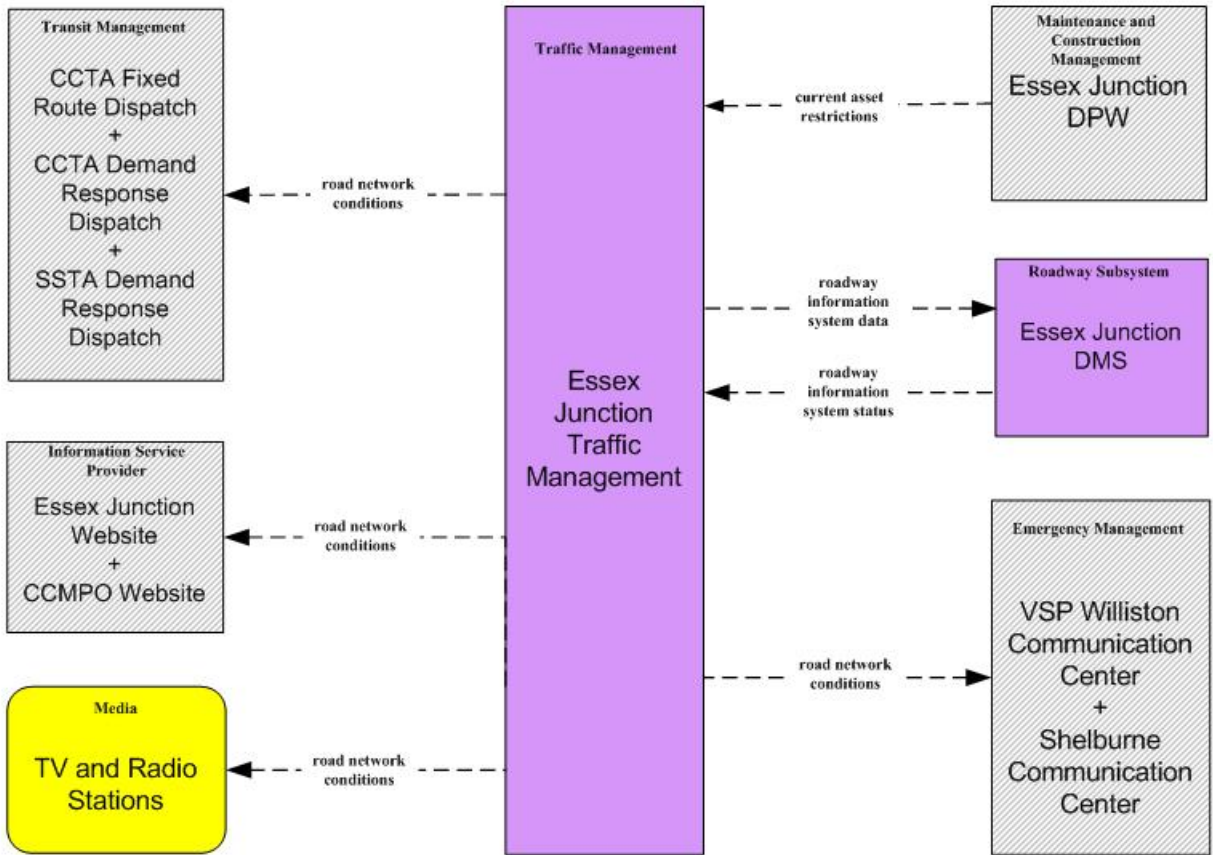

ATMS06 – Traffic Information Dissemination
Municipal Traffic Management

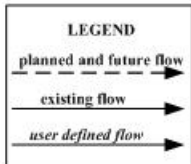
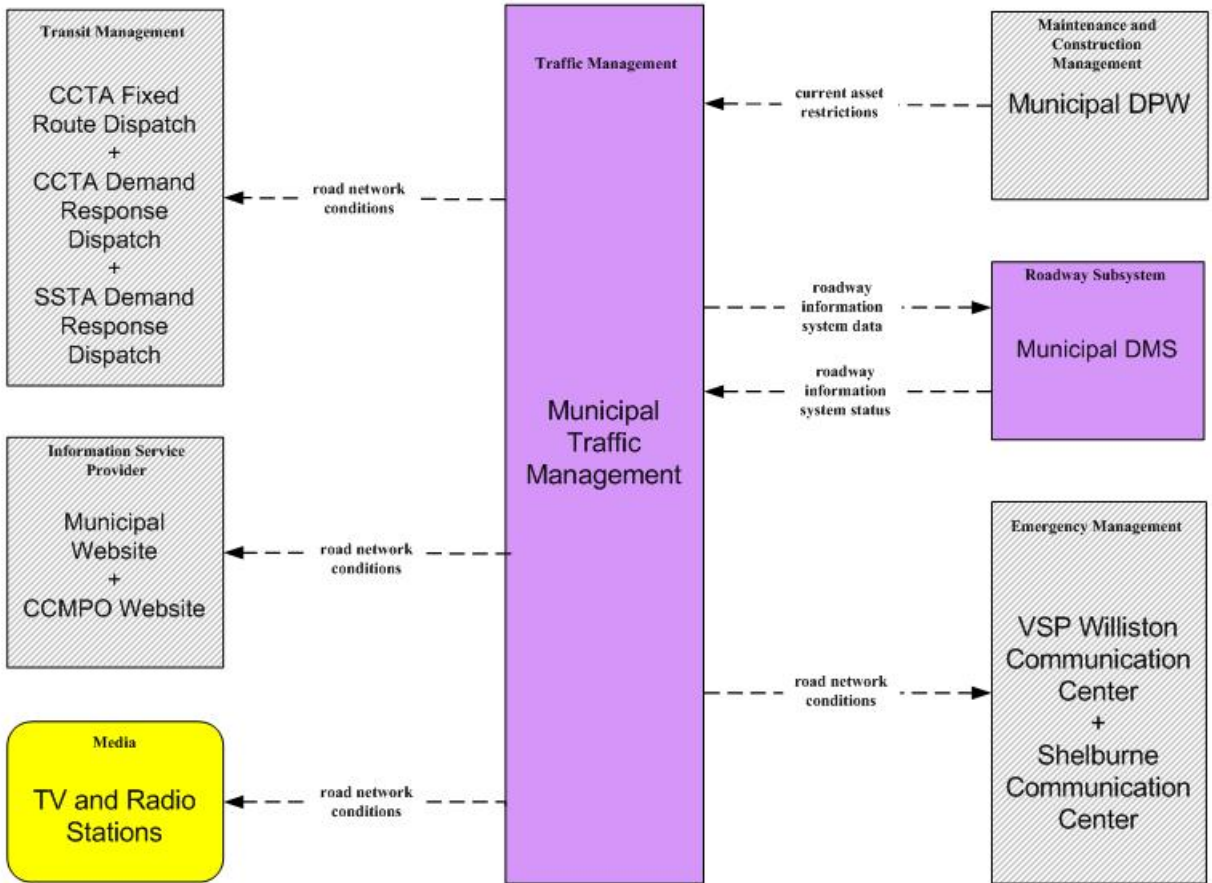

ATMS06 – Traffic Information Dissemination
Shelburne Traffic Management

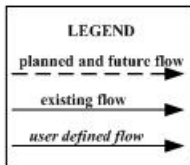
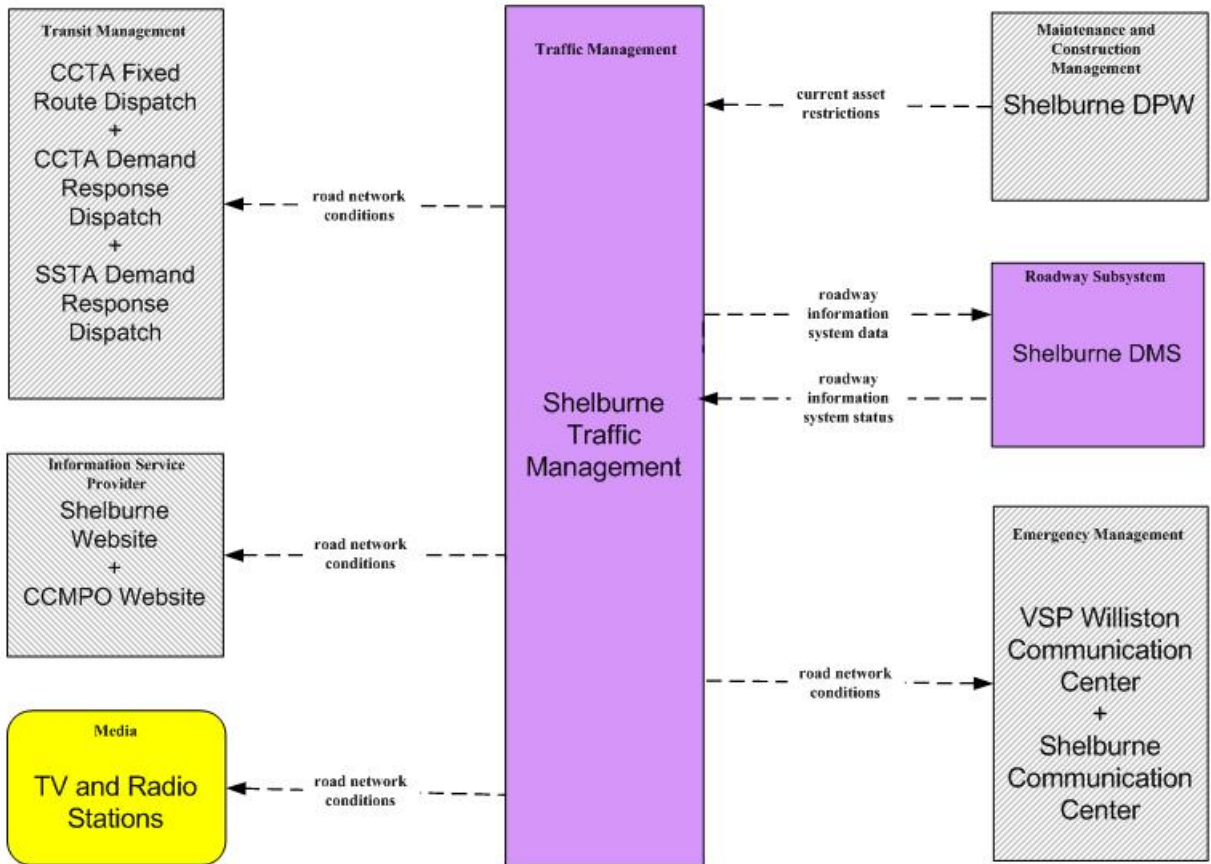

ATMS06 – Traffic Information Dissemination South Burlington Traffic Management

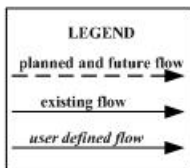
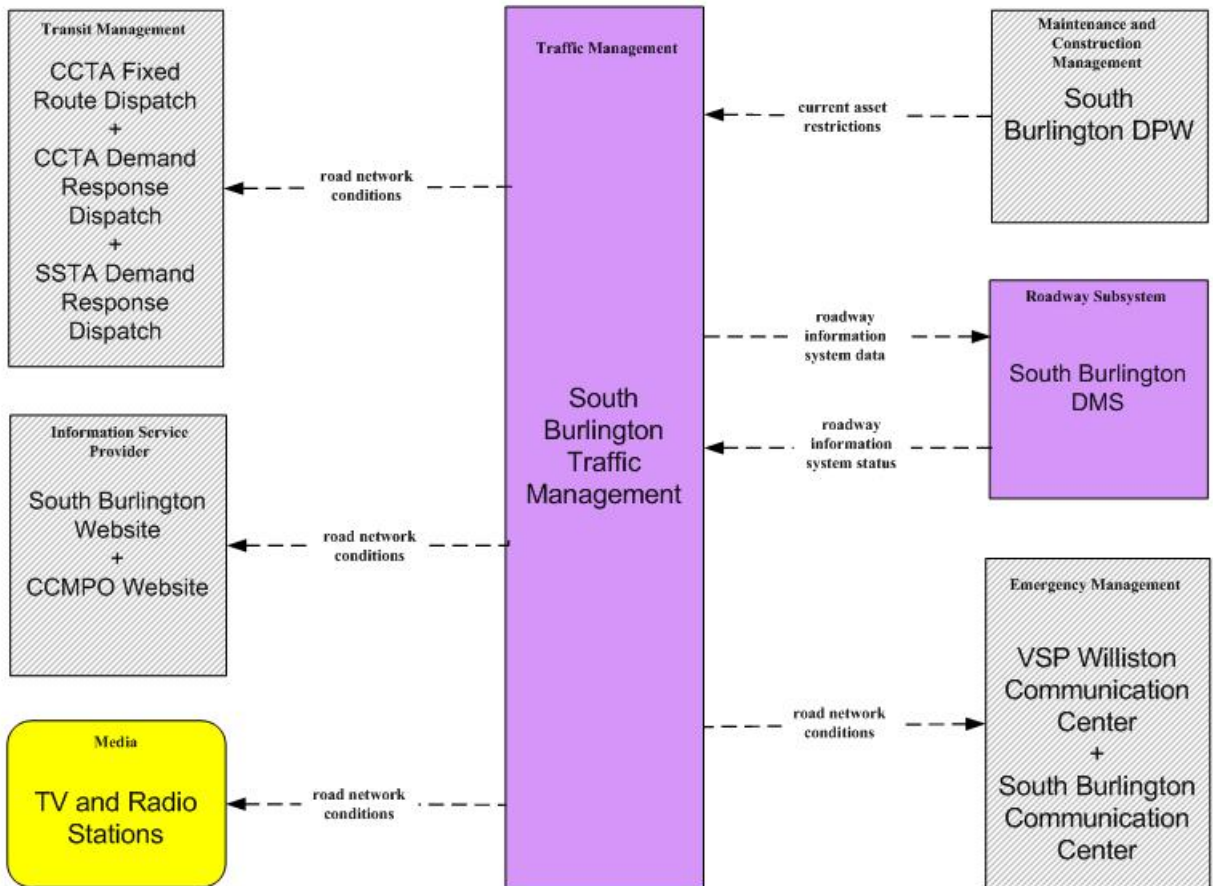

ATMS06 – Traffic Information Dissemination
Williston Traffic Management

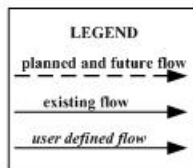
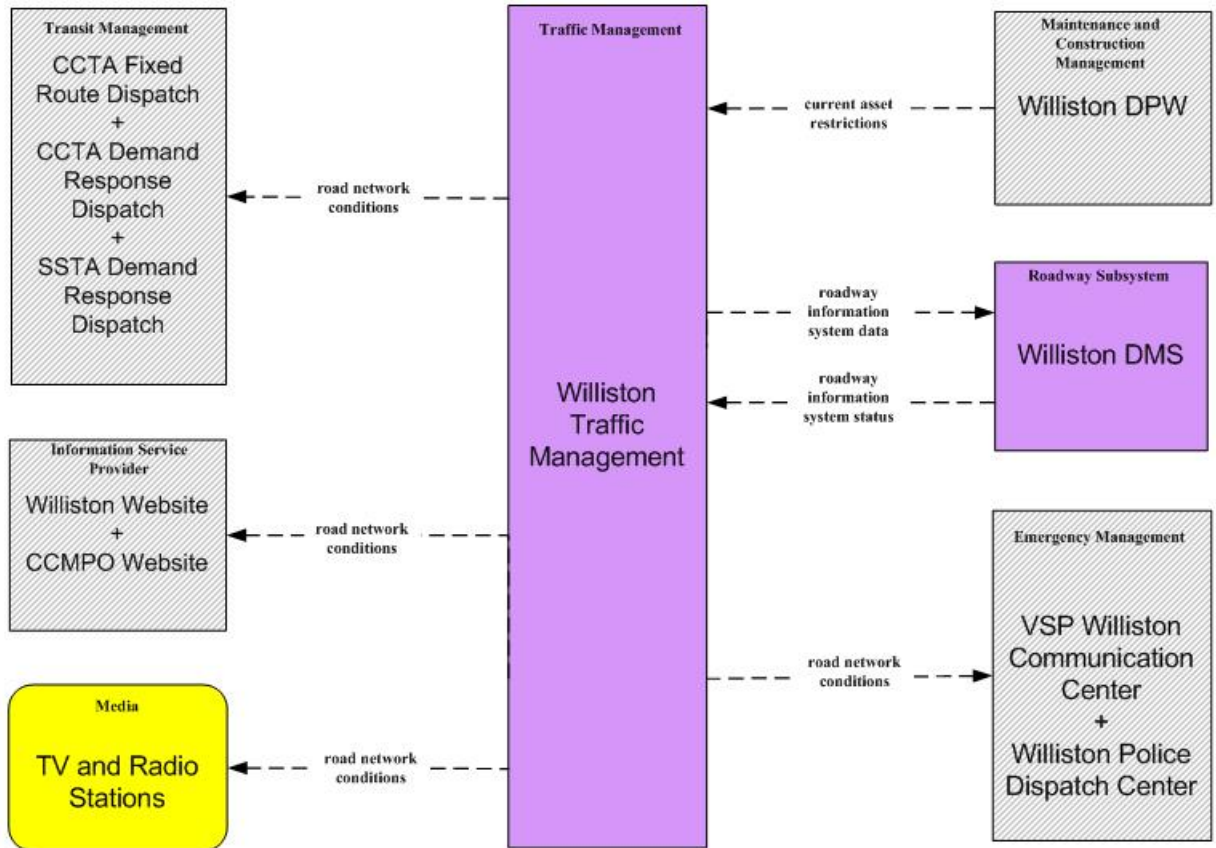

ATMS06 – Traffic Information Dissemination Winooski Traffic Management

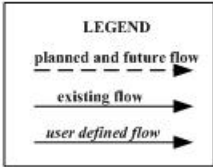
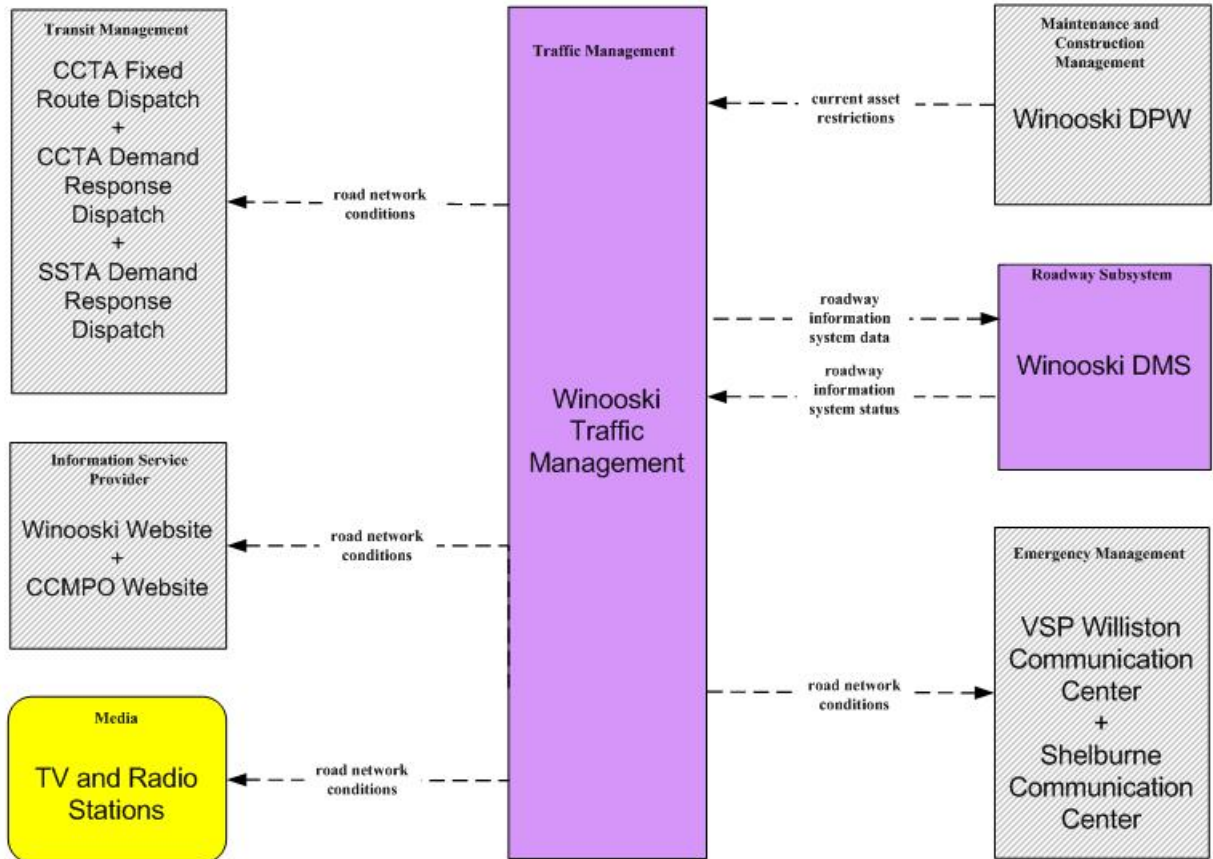

**EMO6 – Wide Area Alert
Vermont Statewide EOC & VSP Headquarters**

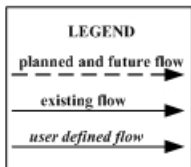
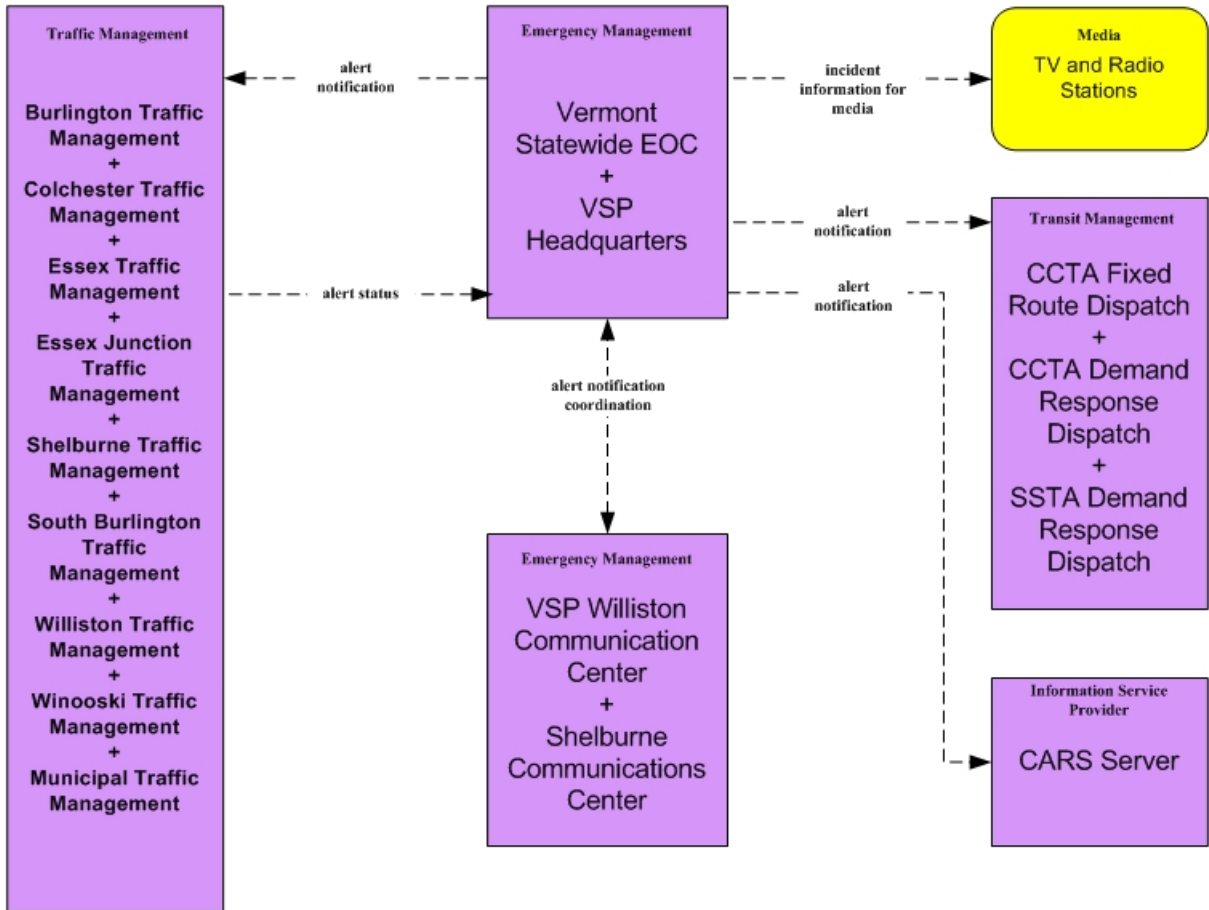

EMO6 – Wide Area Alert
 Vermont Statewide EOC & VSP Headquarters – Chittenden Regional TOC

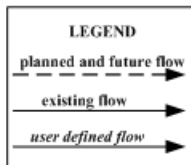
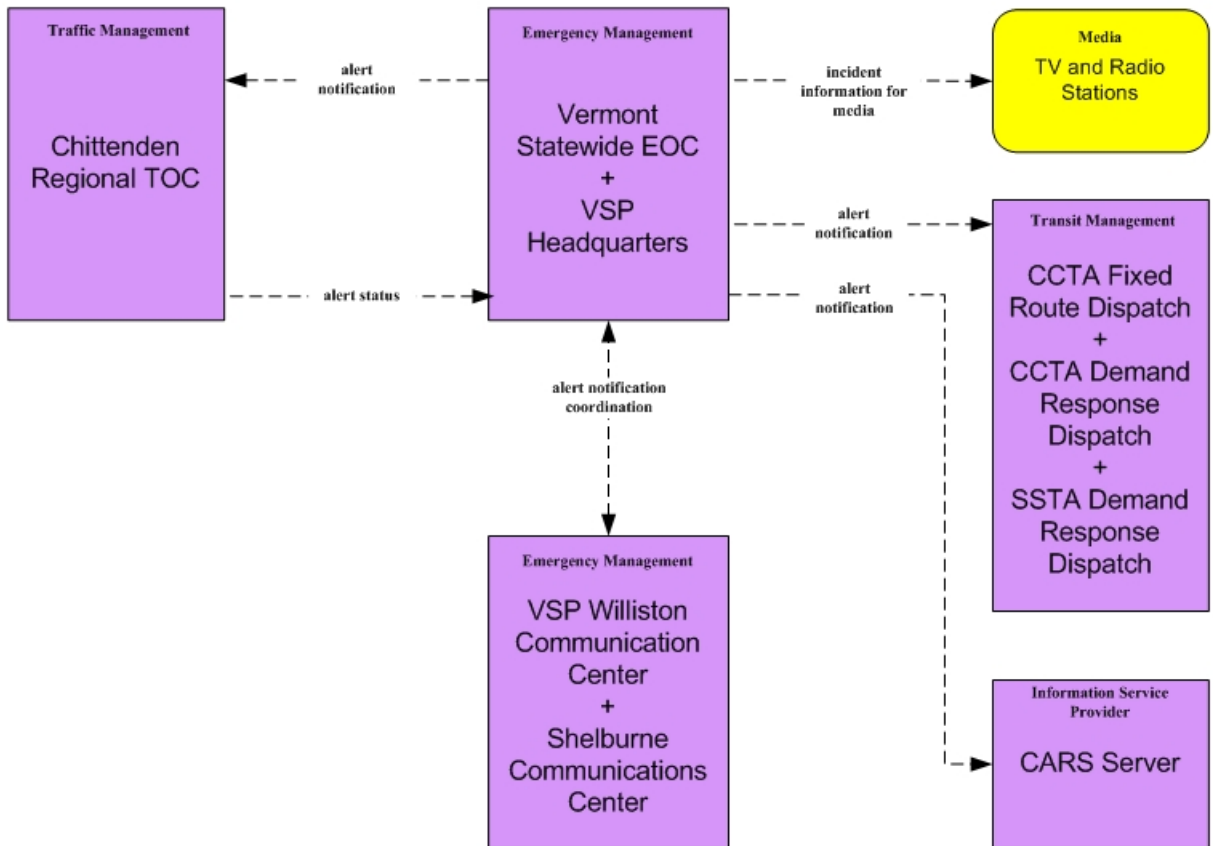

EM09 - Evacuation and Reentry Management
Vermont Statewide EOC

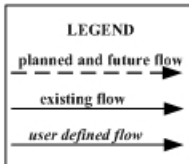
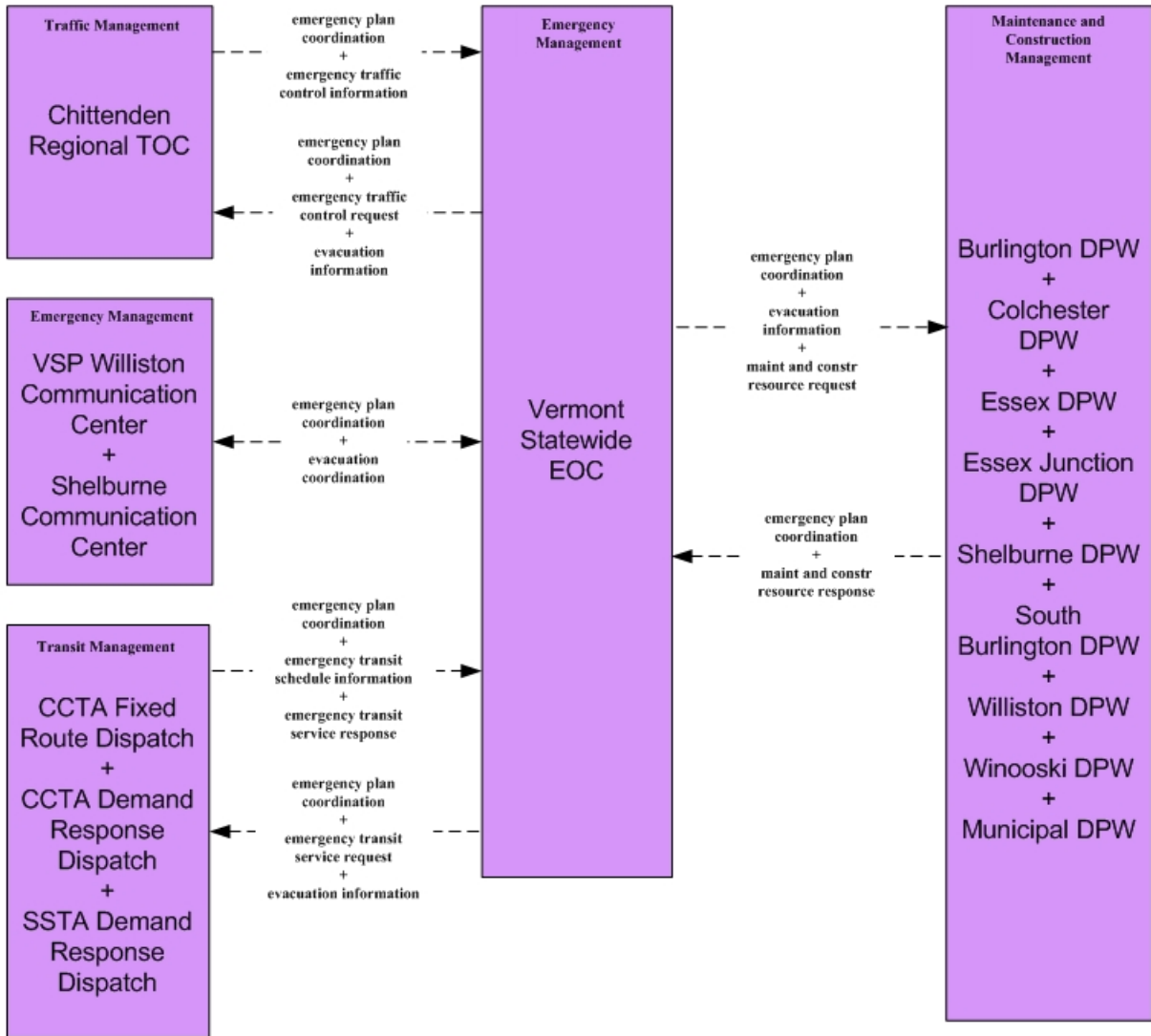

MC04 - Weather Information Processing and Distribution
CARS

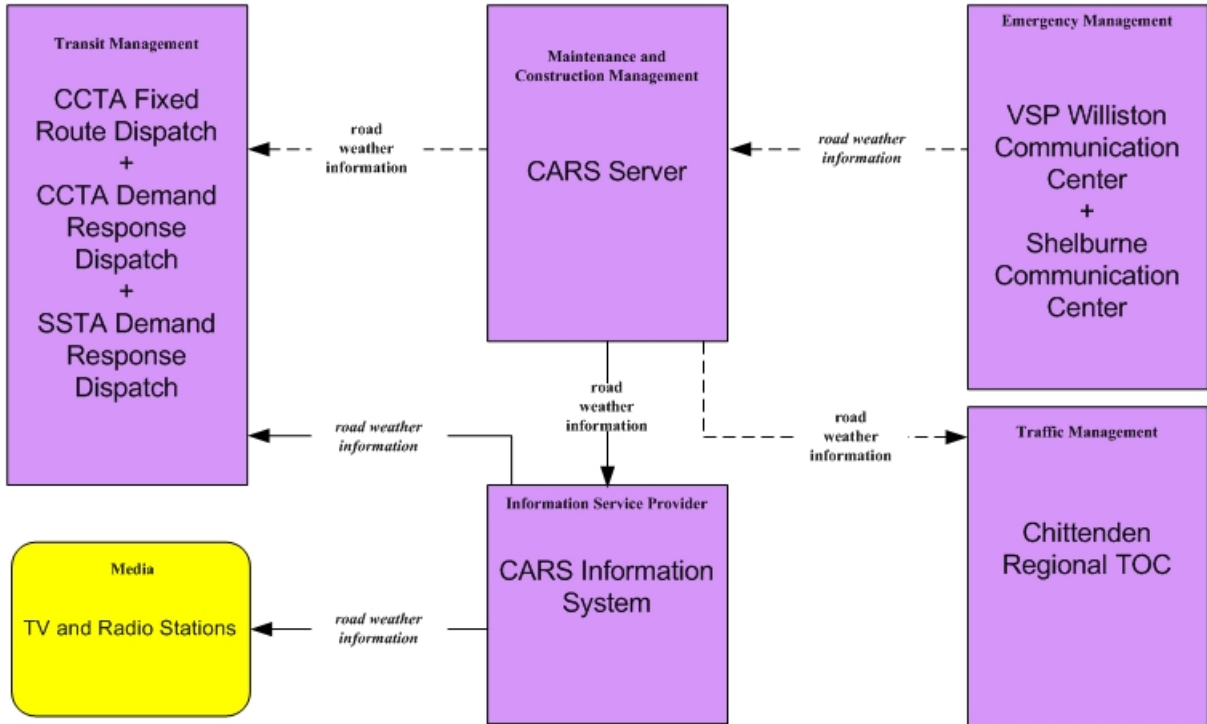

LEGEND

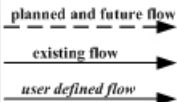

MC04 – Weather Information Processing and Distribution
Chittenden Regional TOC

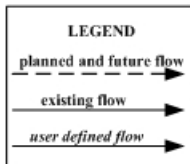
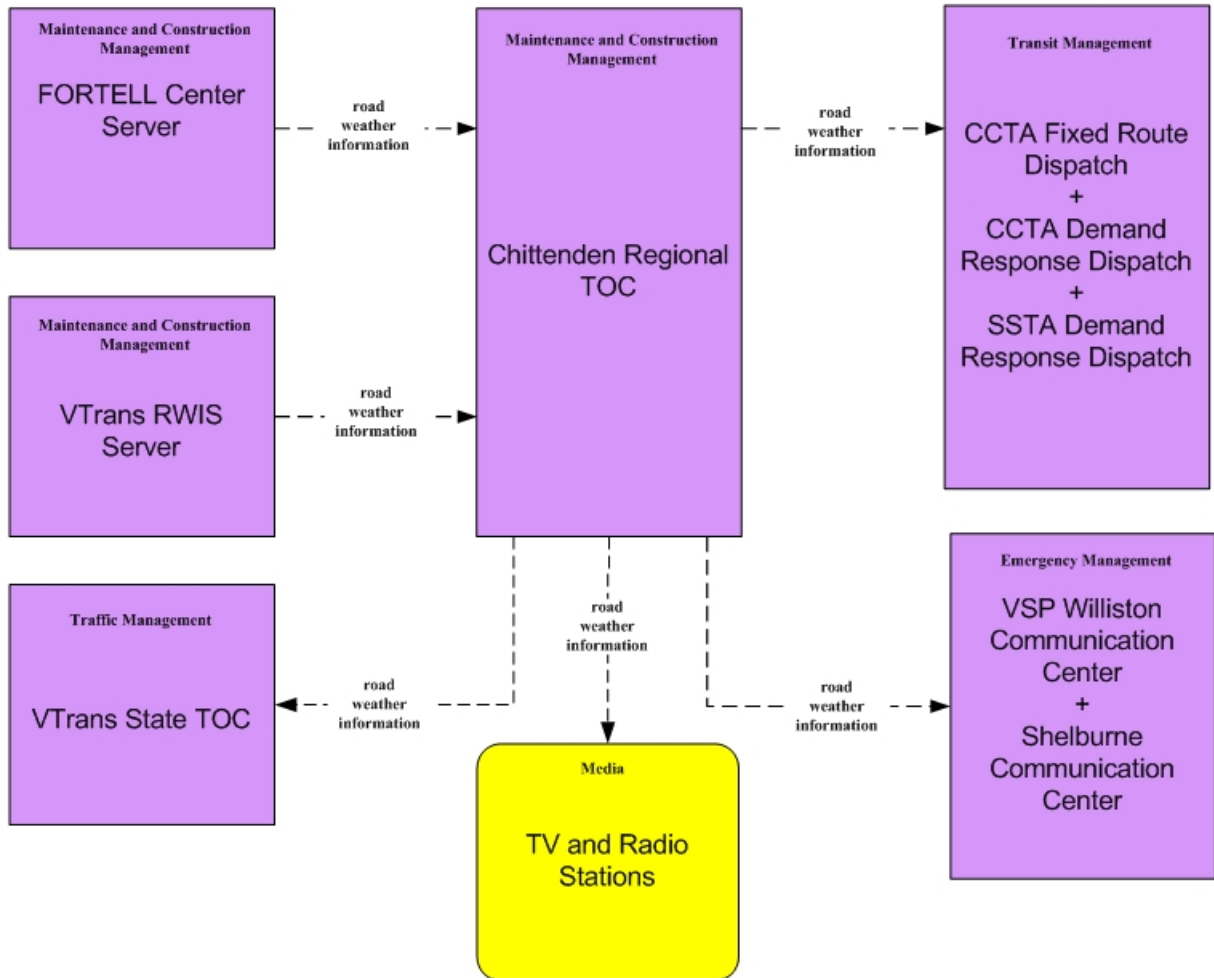

MC04 - Weather Information Processing and Distribution
Weather Services

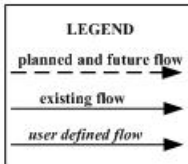
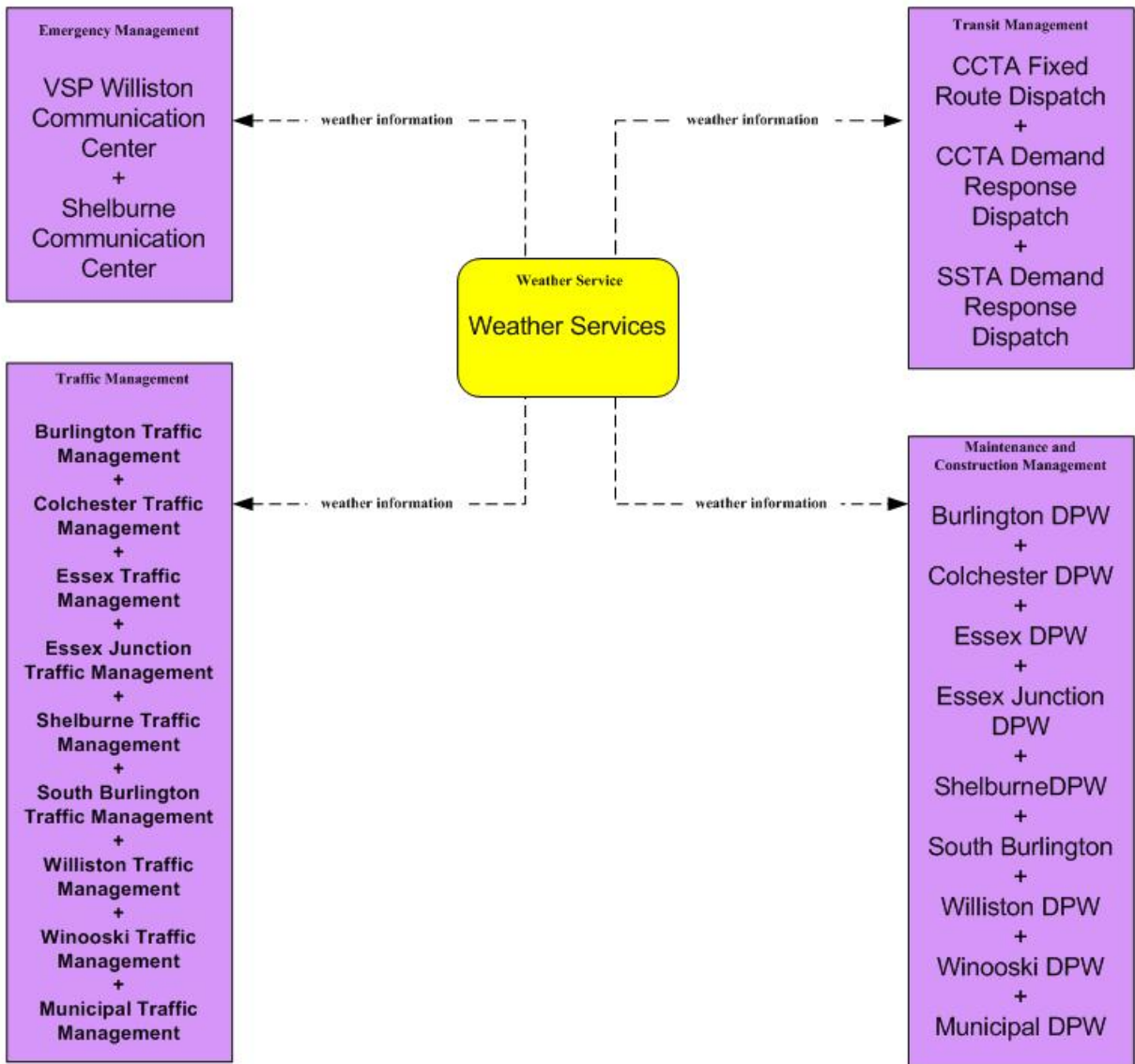

This instance represents the situation for this market package with existing entities only. See the MC04 – Weather Services (Chittenden Regional TOC) instance for market package details pending creation of the Chittenden Regional TOC.

MC04 - Weather Information Processing and Distribution
Weather Services – Chittenden Regional TOC

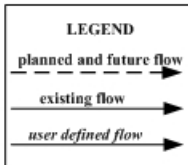
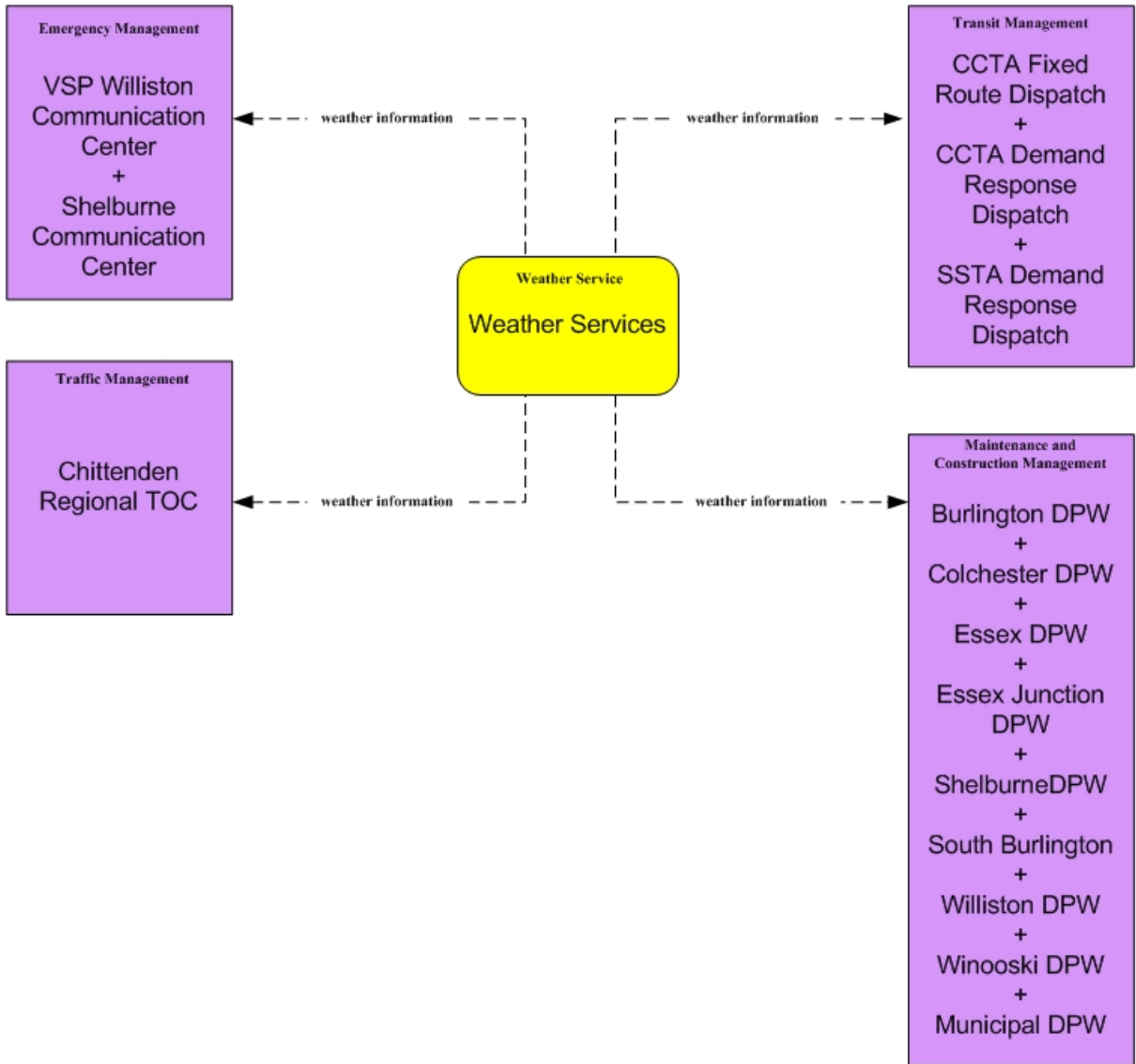

This instance represents the situation for this market package pending creation of the Chittenden Regional TOC. See the MC04 – Weather Services instance for market package details with existing entities only.

MC06 - Winter Maintenance
Burlington DPW

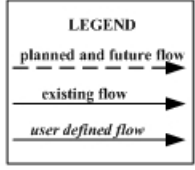
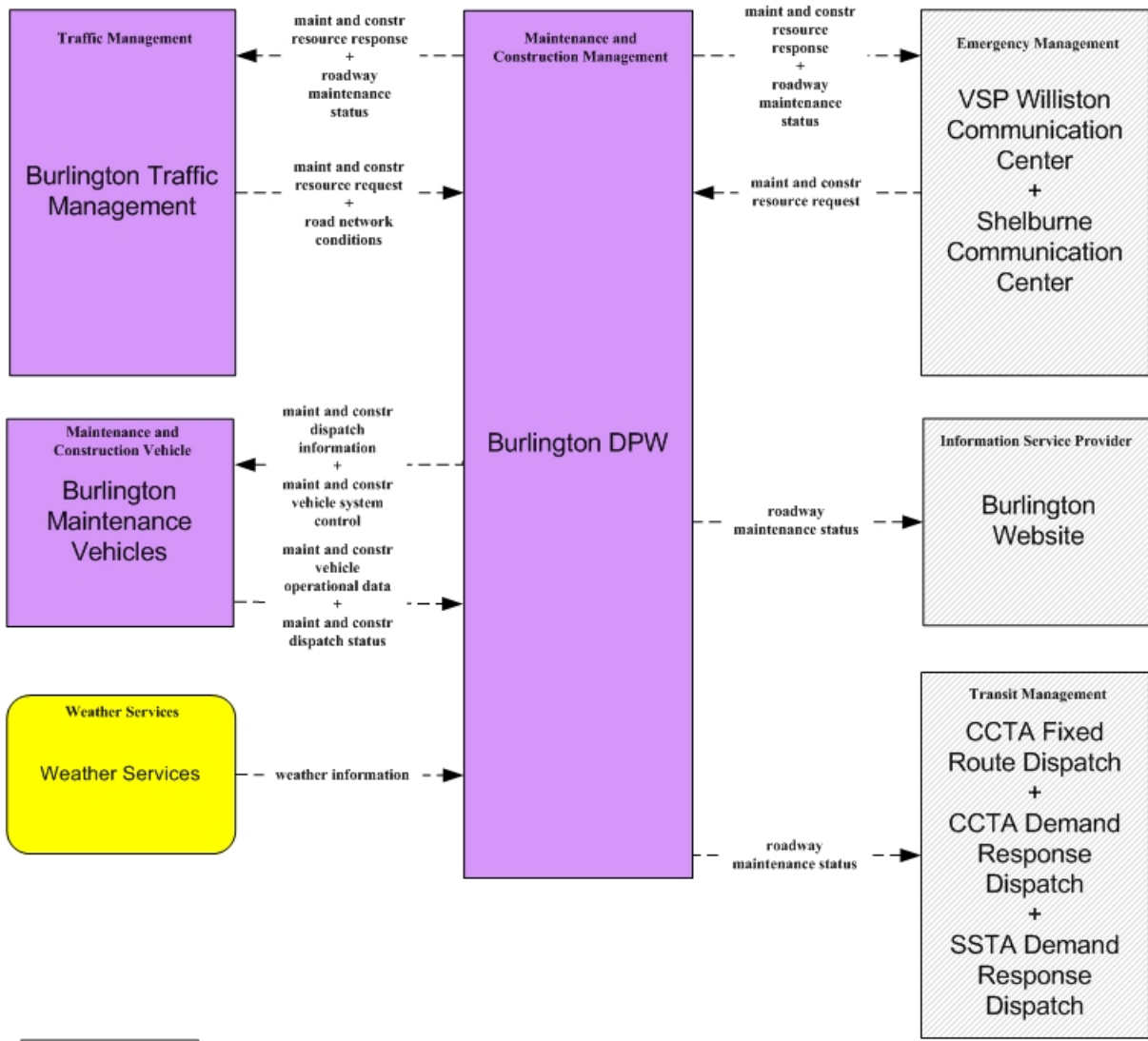

MC06 - Winter Maintenance
Colchester DPW

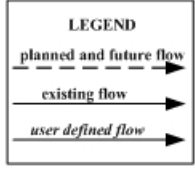
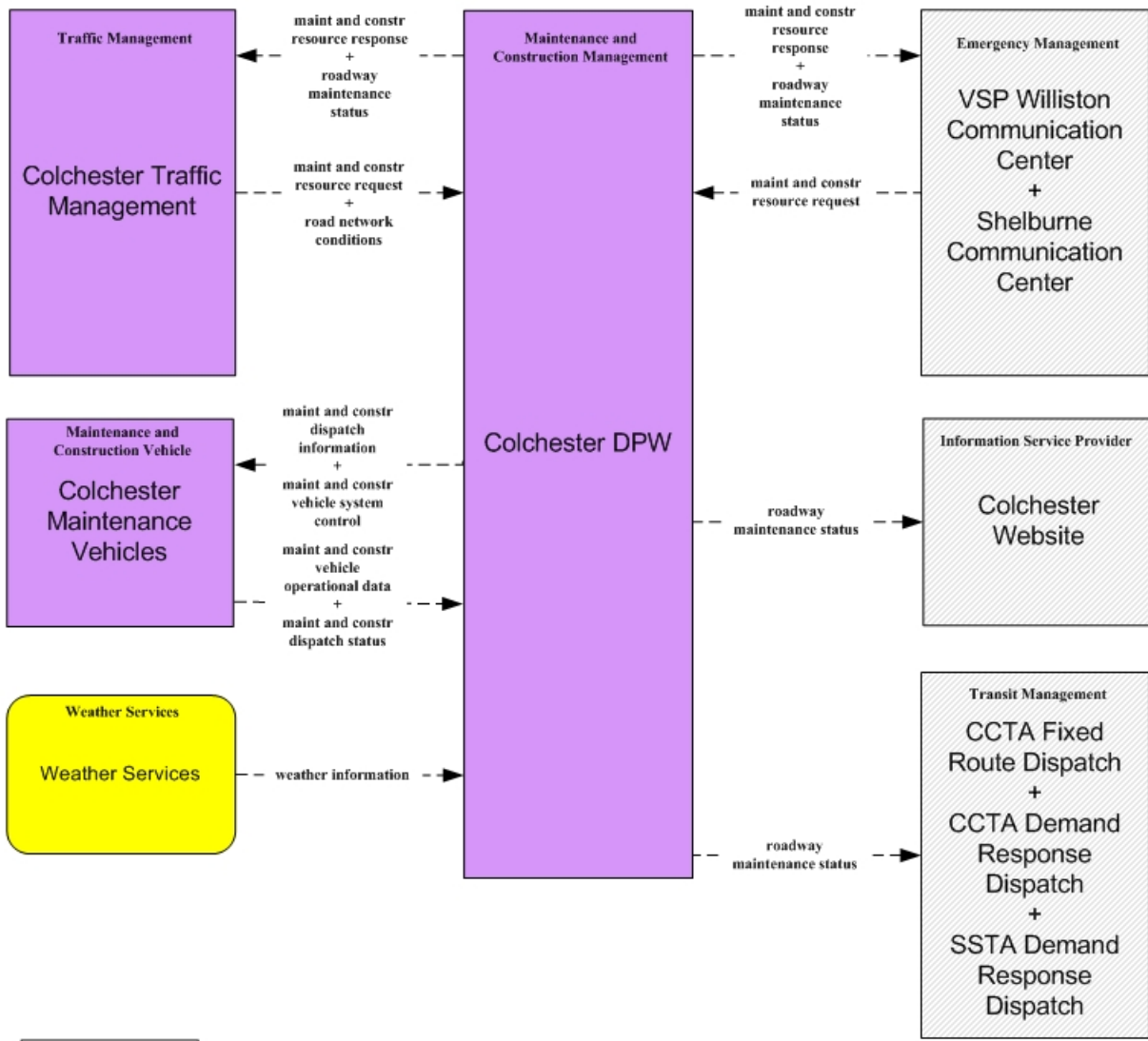

MC06 - Winter Maintenance
Essex DPW

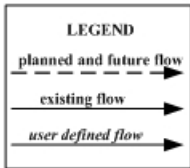
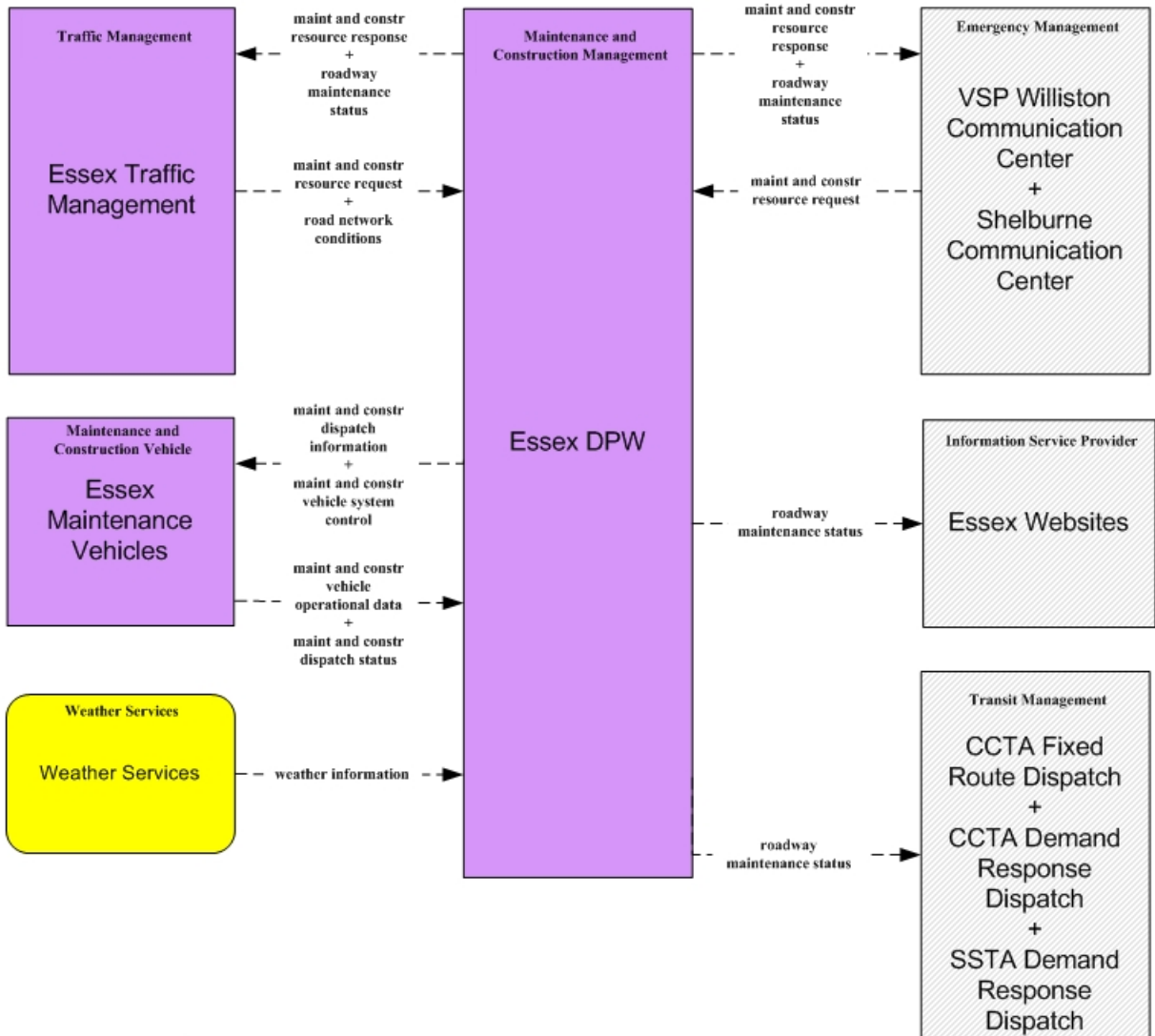

MC06 - Winter Maintenance
Essex Junction DPW

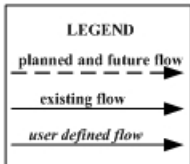
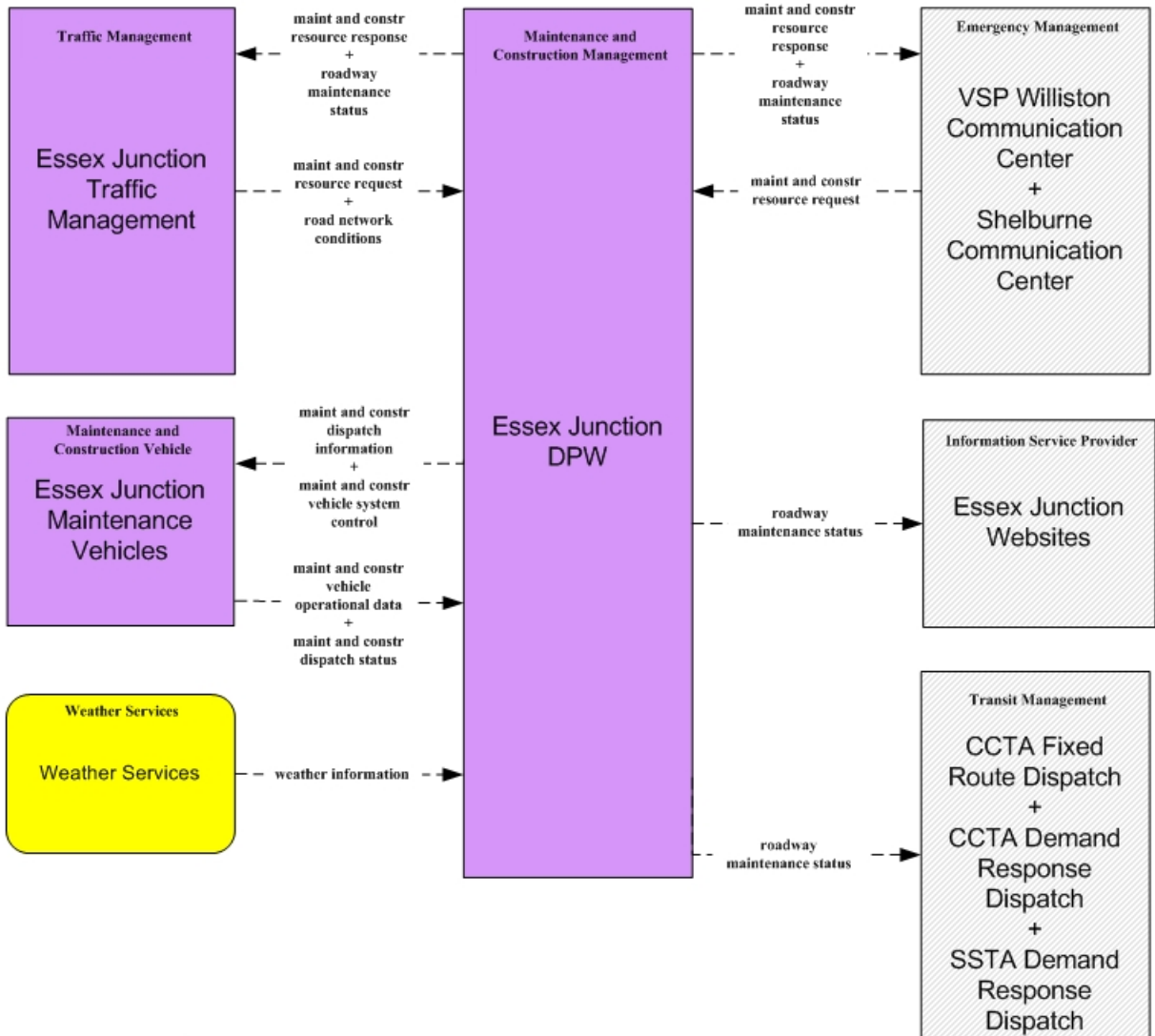

MC06 - Winter Maintenance
Municipal DPW

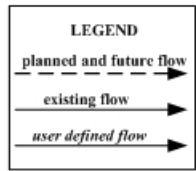
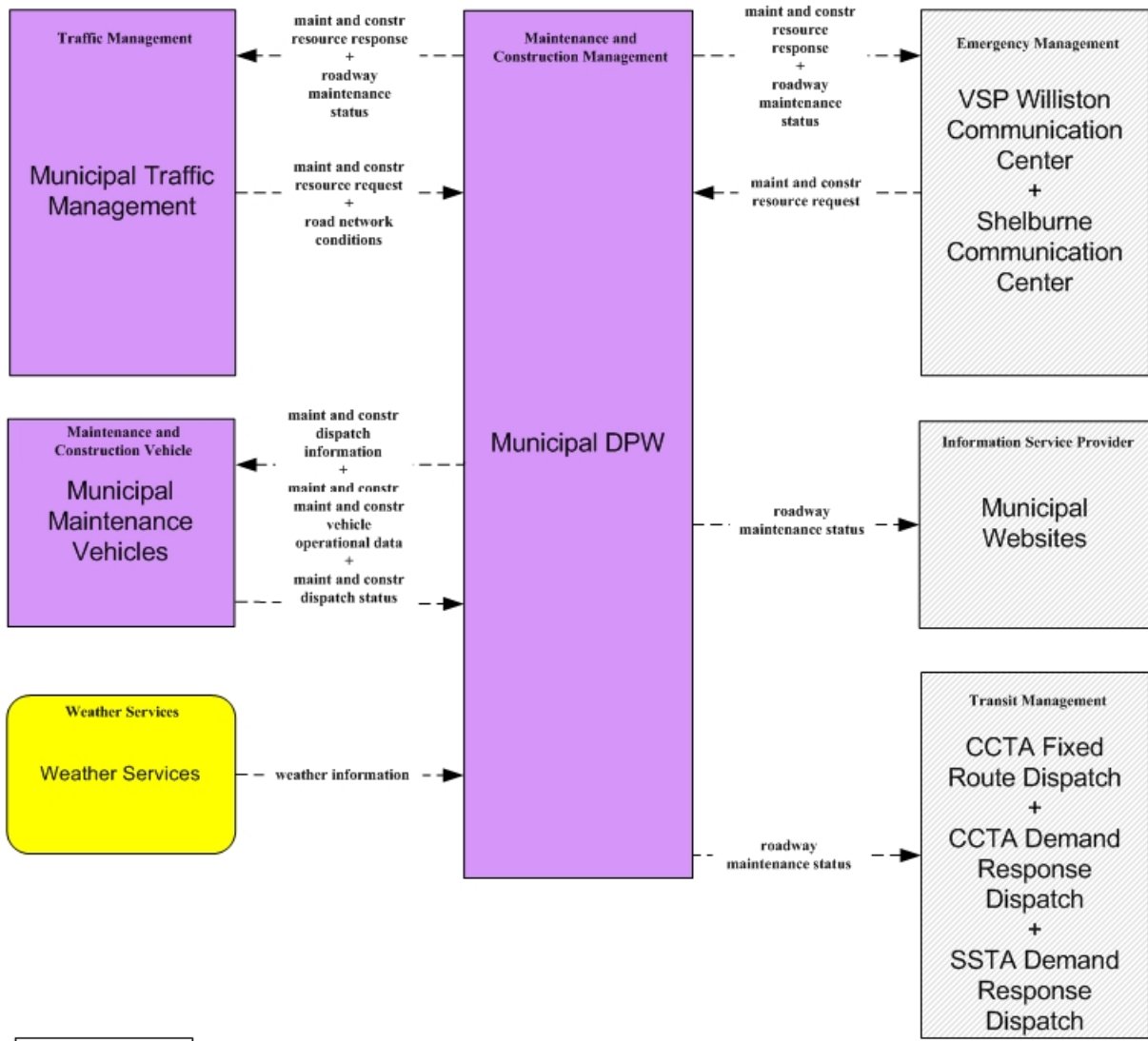

MC06 - Winter Maintenance
Shelburne DPW

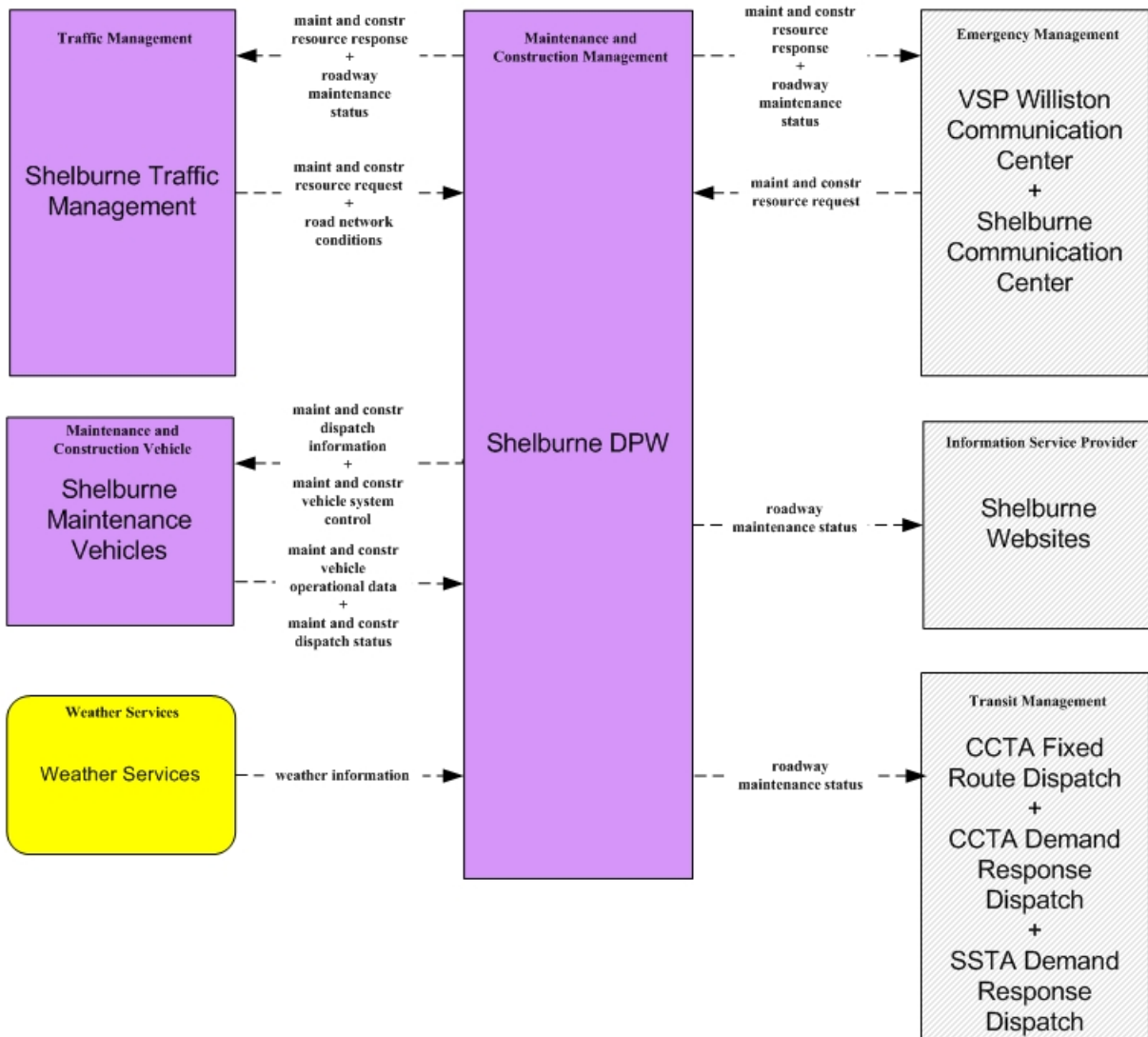

LEGEND

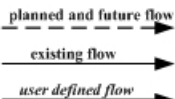

MC06 - Winter Maintenance
South Burlington DPW

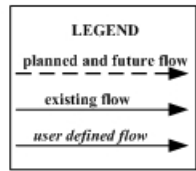
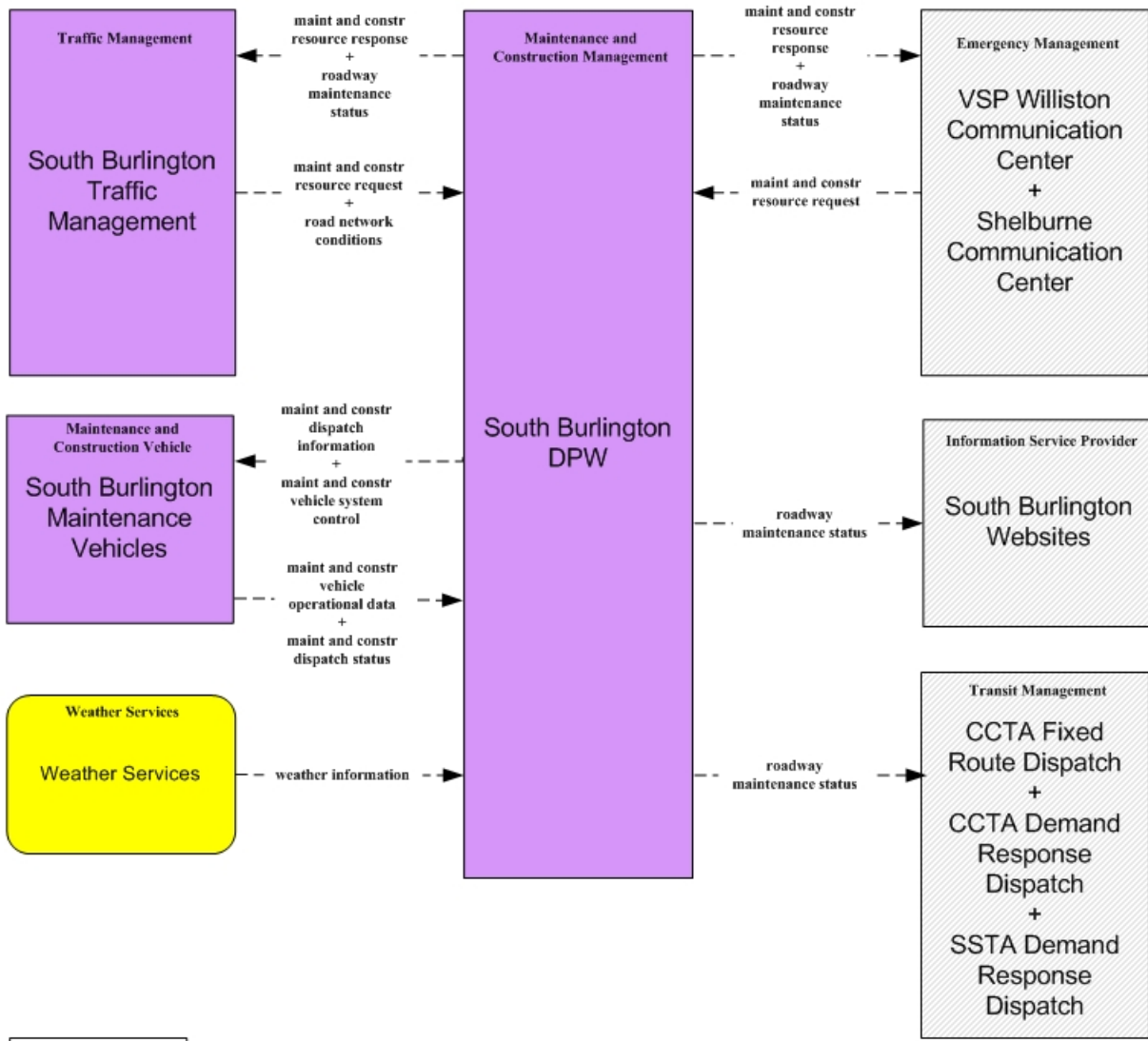

MC06 - Winter Maintenance
VTrans District Maintenance Dispatch

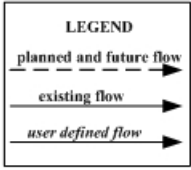
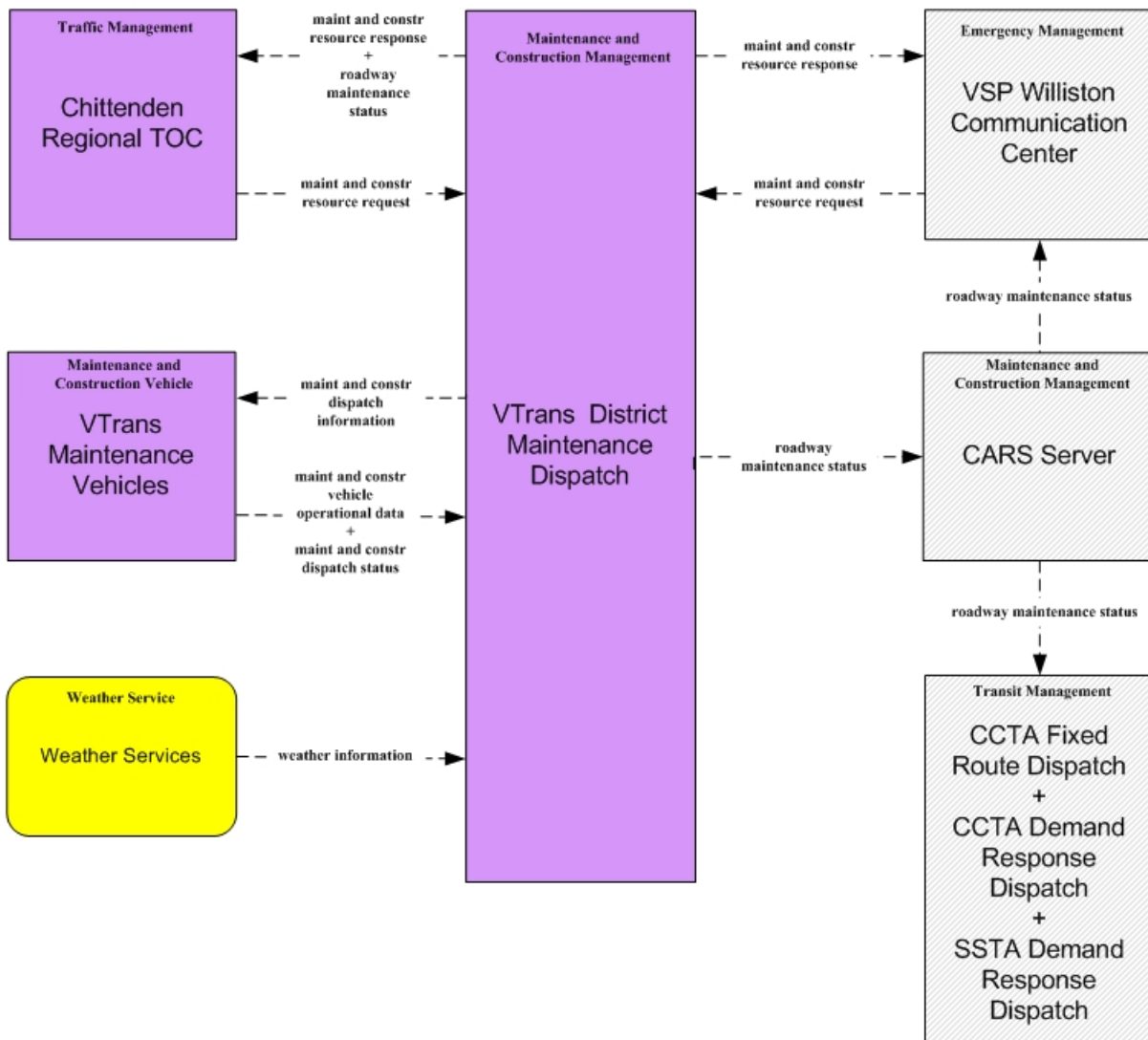

MC06 - Winter Maintenance
Williston DPW

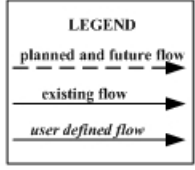
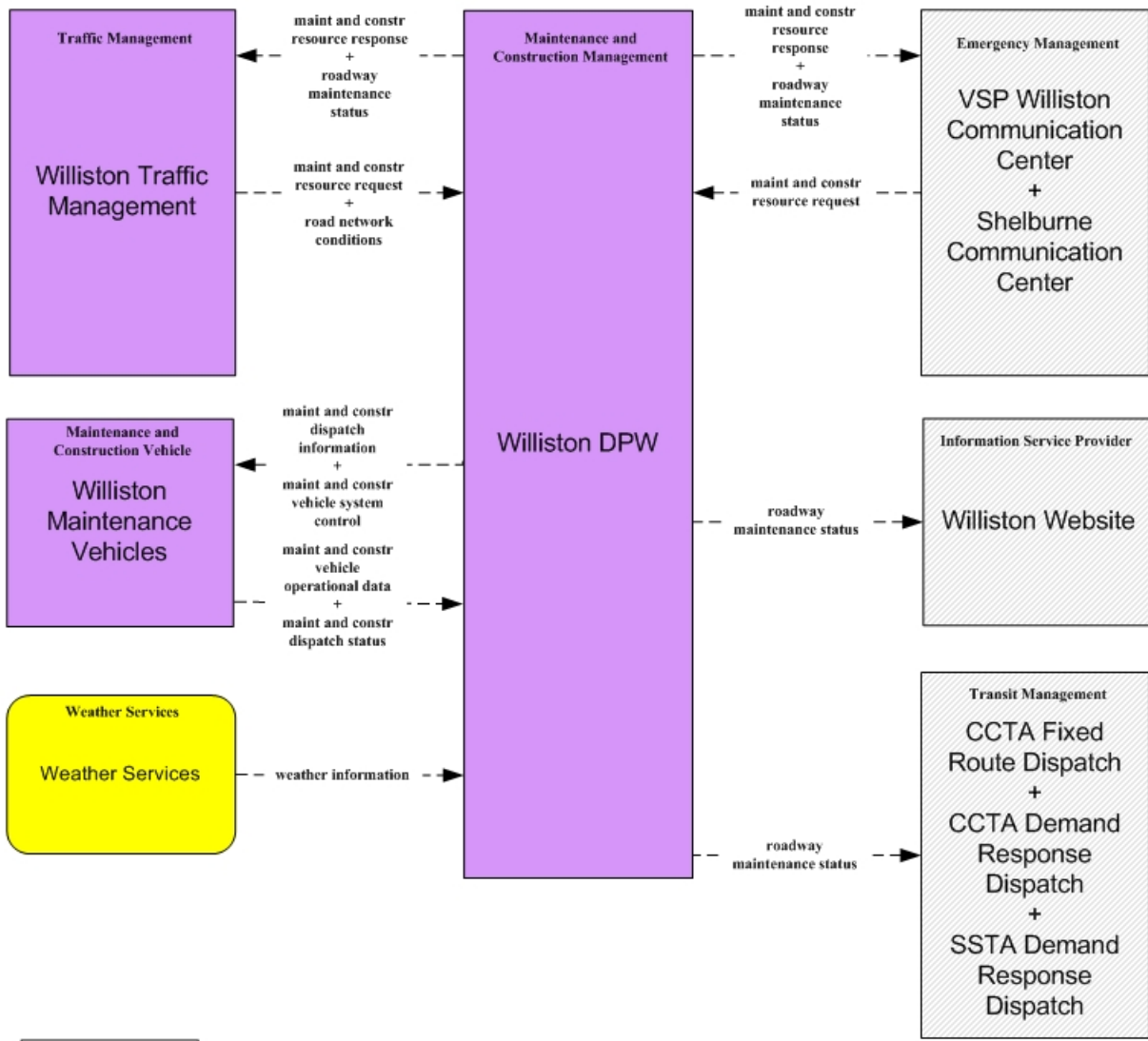

MC06 - Winter Maintenance
Winooski DPW

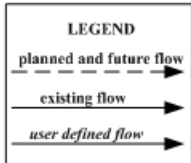
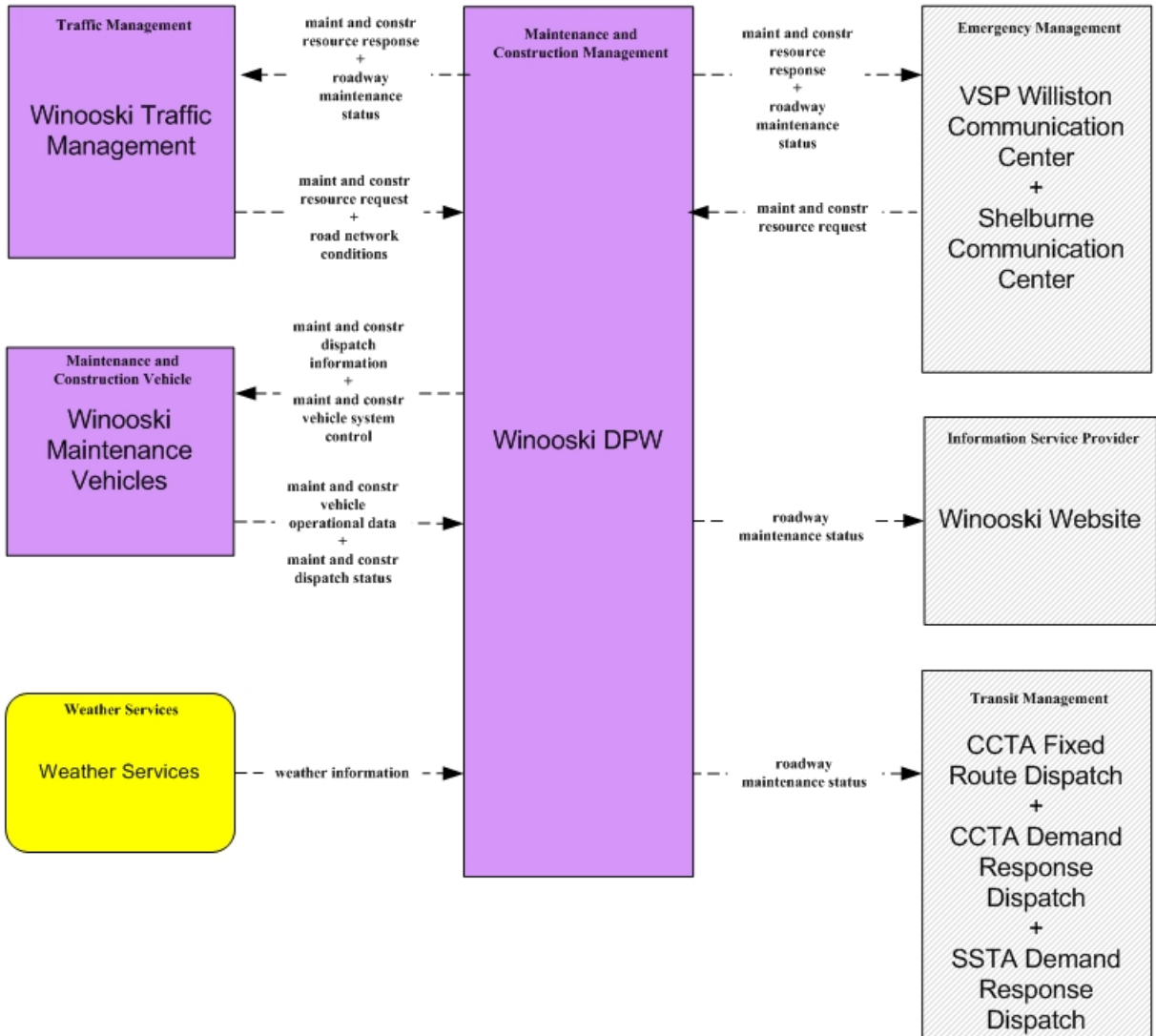

MC08 - Work Zone Management
VTrans District Maintenance Dispatch

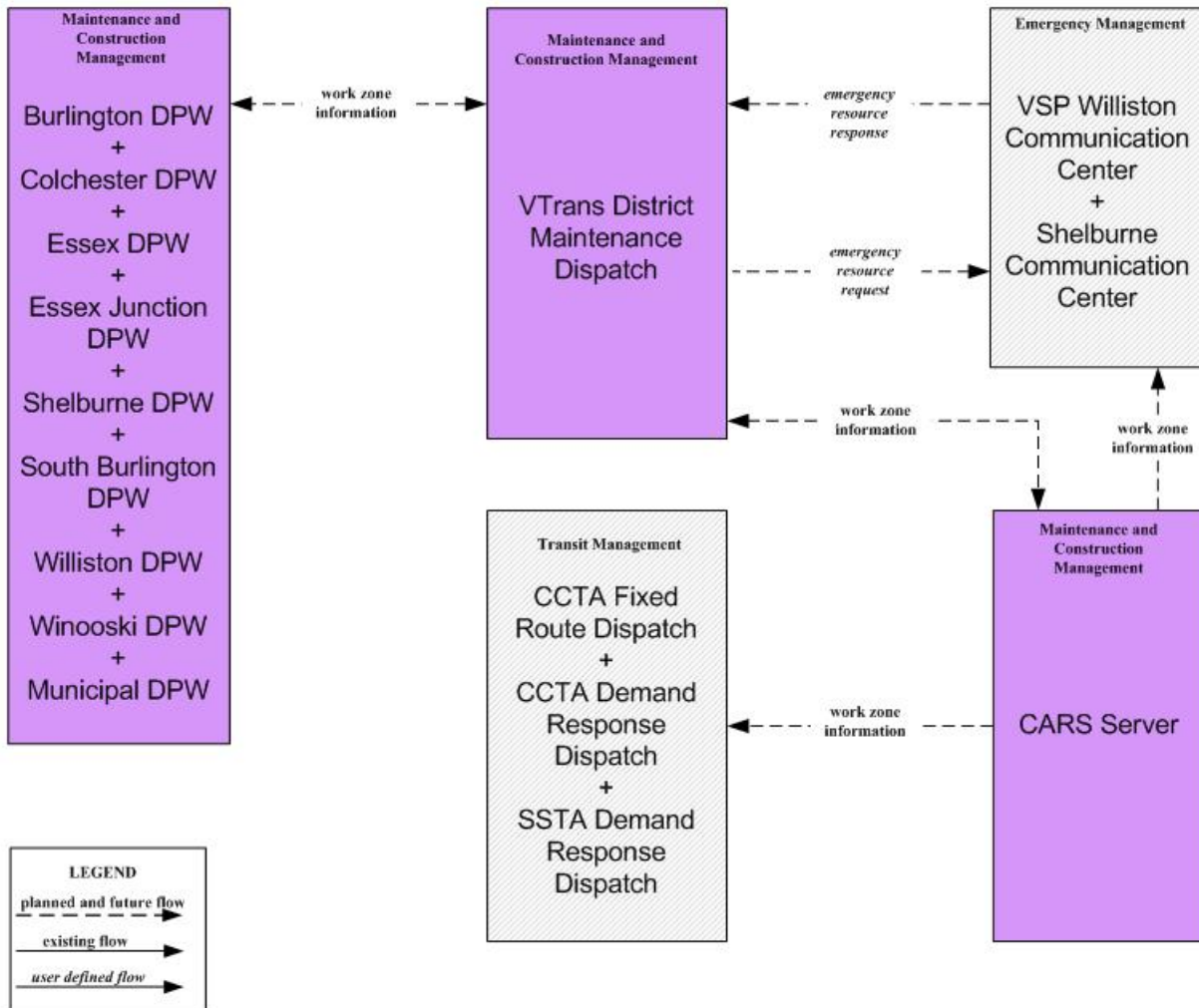

MC10 – Maintenance and Construction Activity Coordination
Burlington DPW

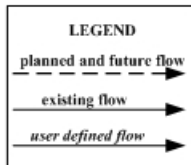
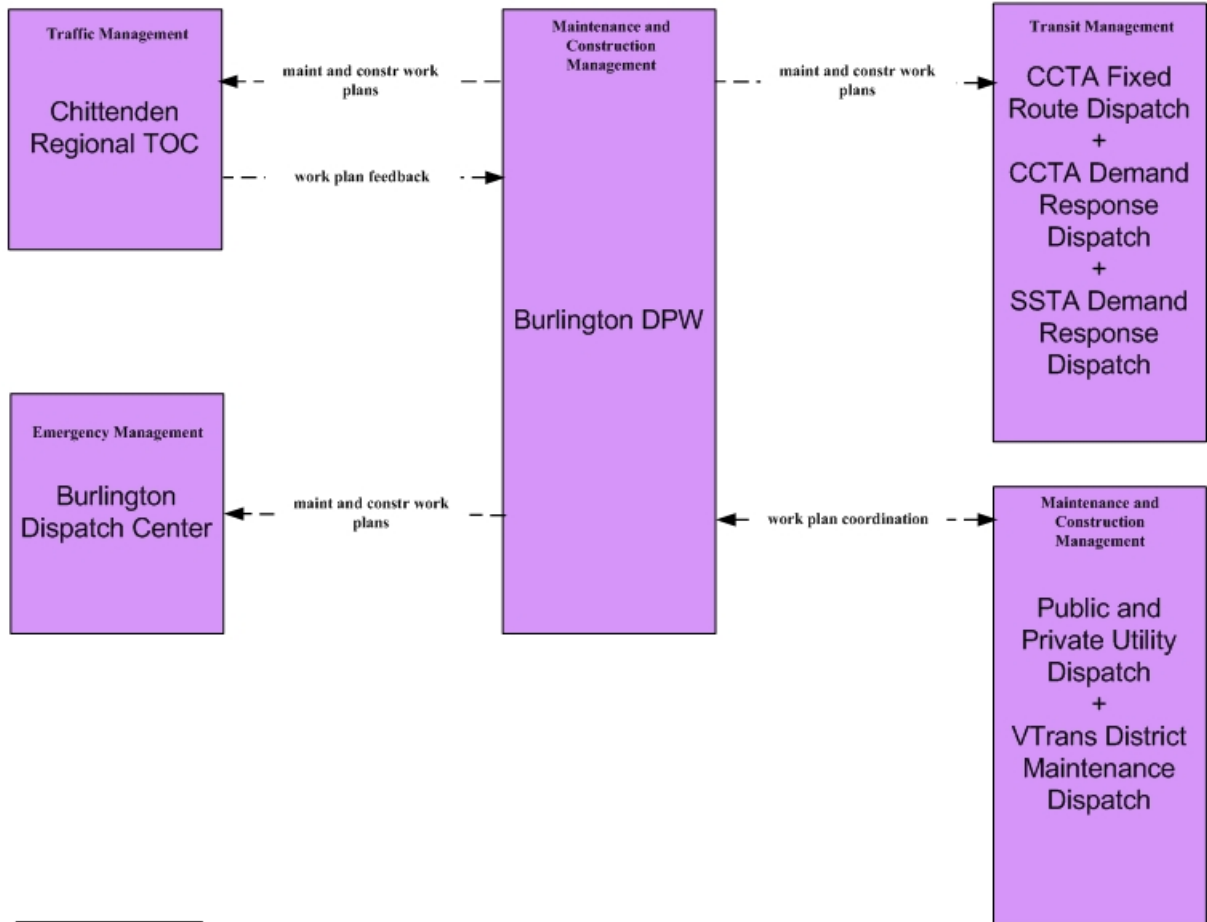

MC10 – Maintenance and Construction Activity Coordination
CARS Information System

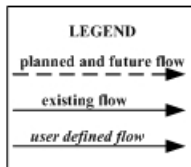
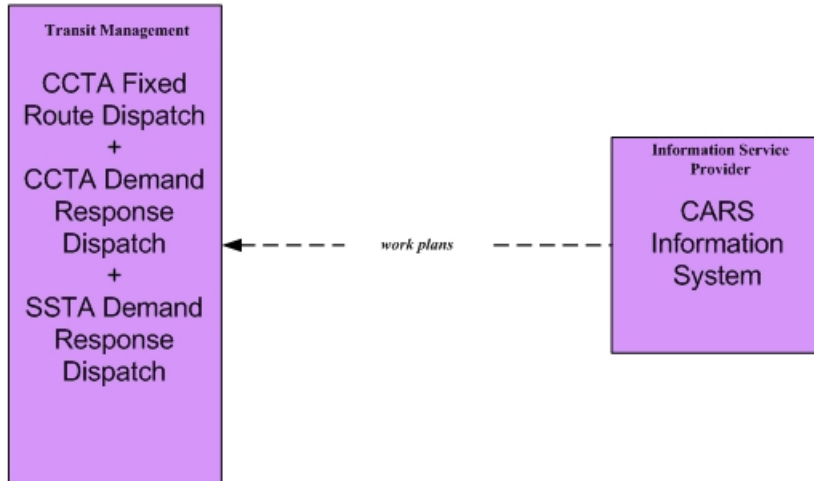

MC10 – Maintenance and Construction Activity Coordination
Colchester DPW

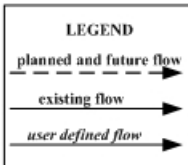
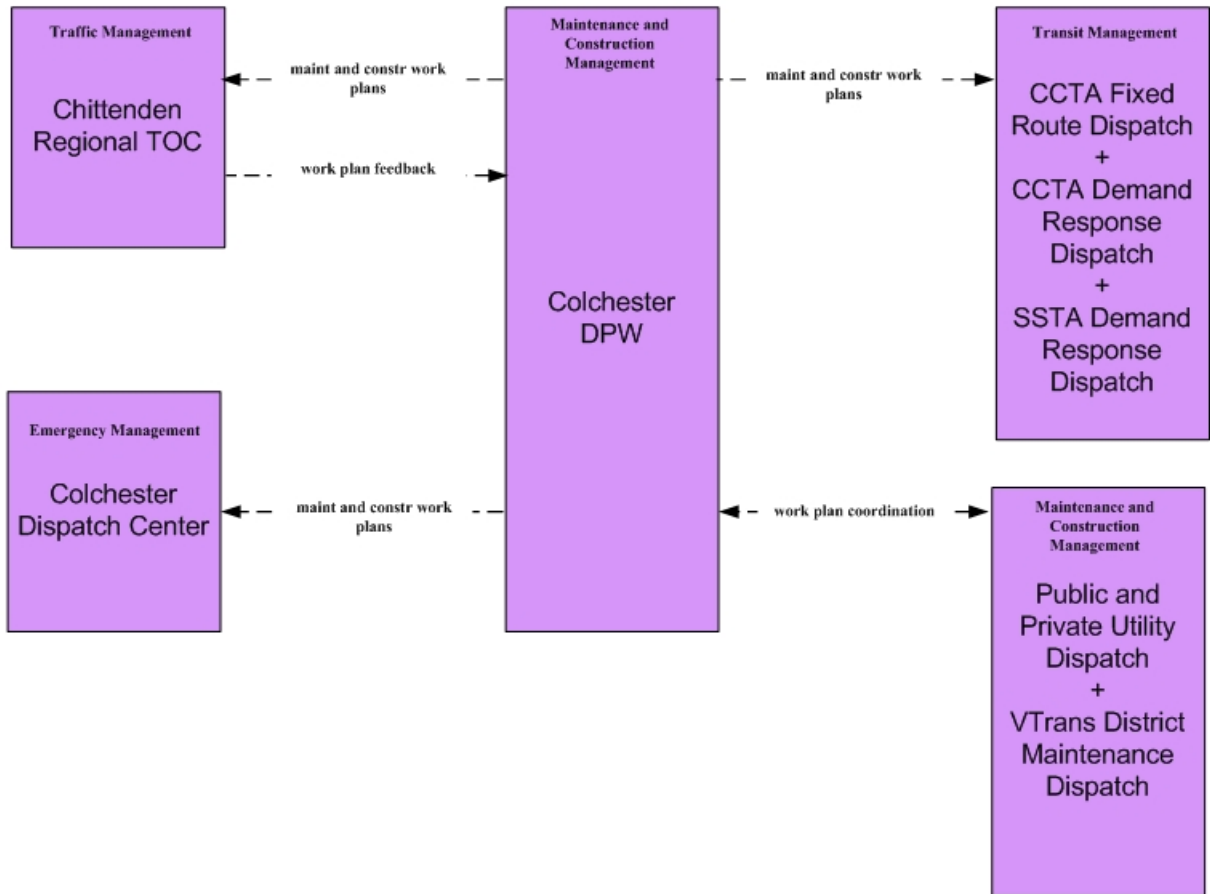

MC10 – Maintenance and Construction Activity Coordination
Essex DPW

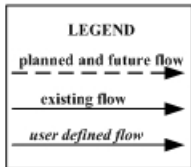
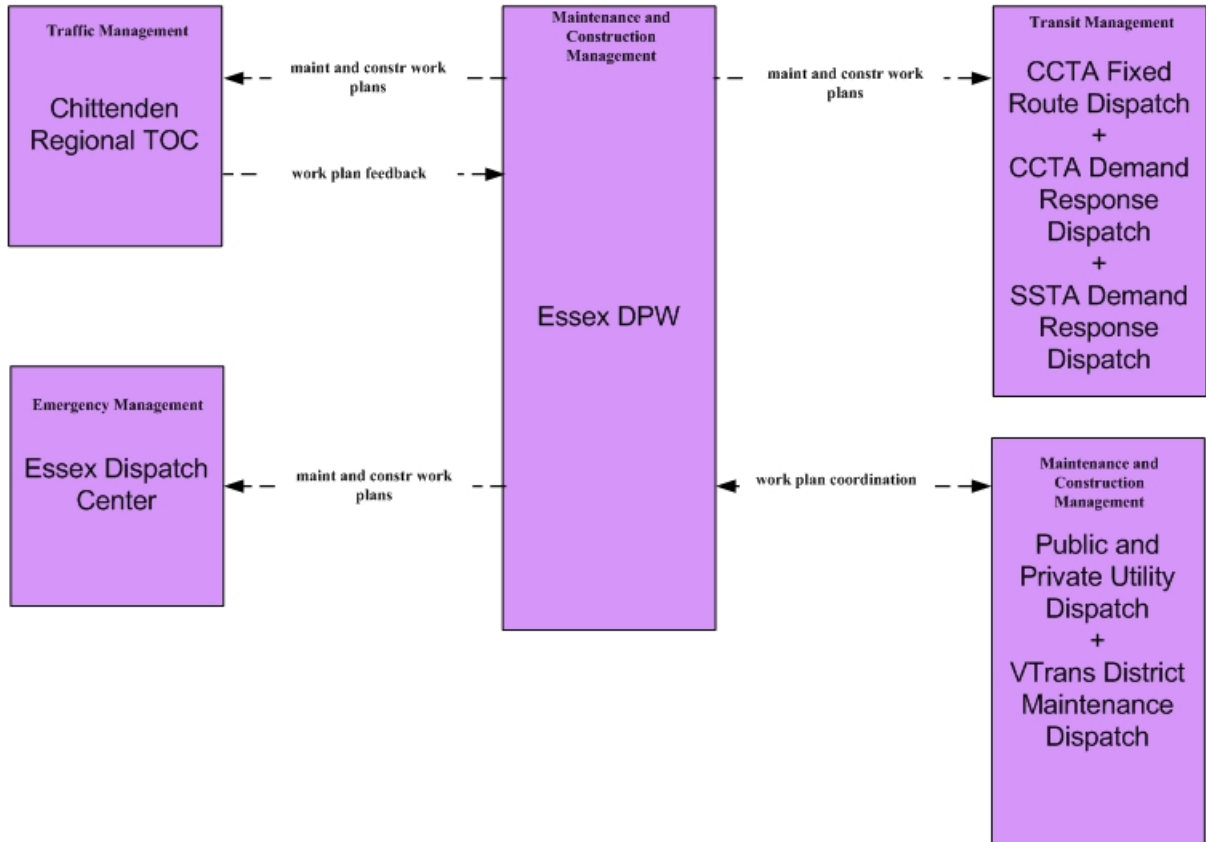

MC10 – Maintenance and Construction Activity Coordination
Essex Junction DPW

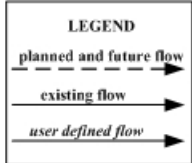
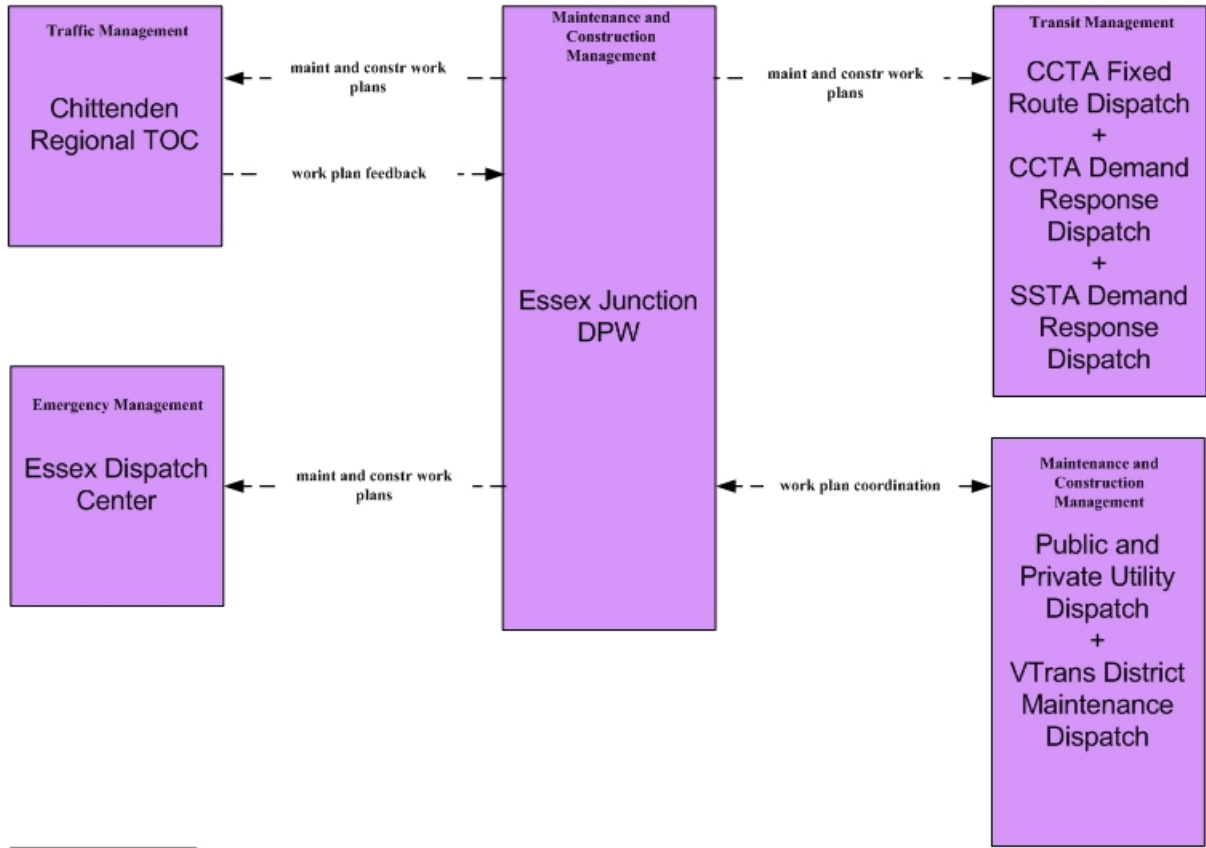

MC10 – Maintenance and Construction Activity Coordination
Municipal DPW

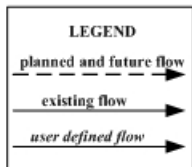
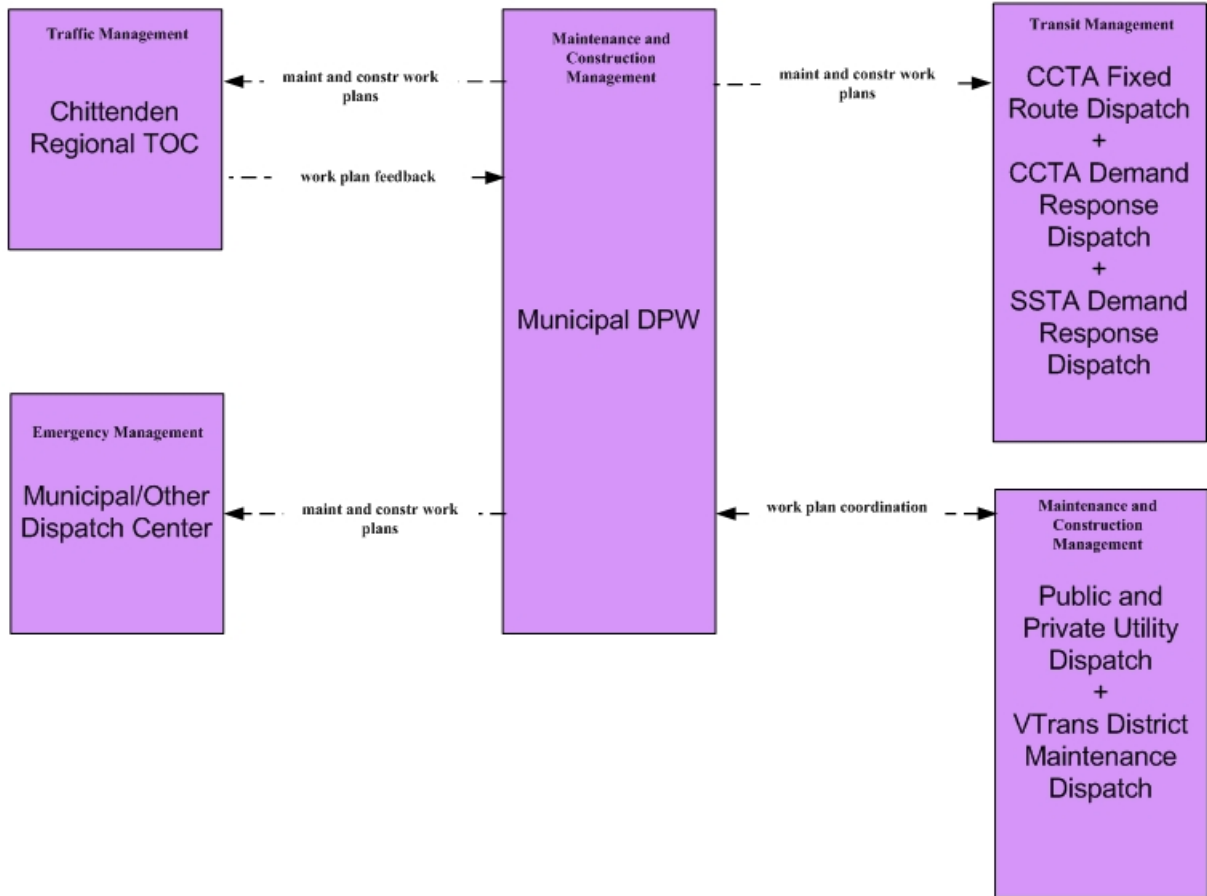

MC10 – Maintenance and Construction Activity Coordination
Shelburne DPW

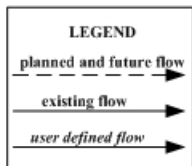
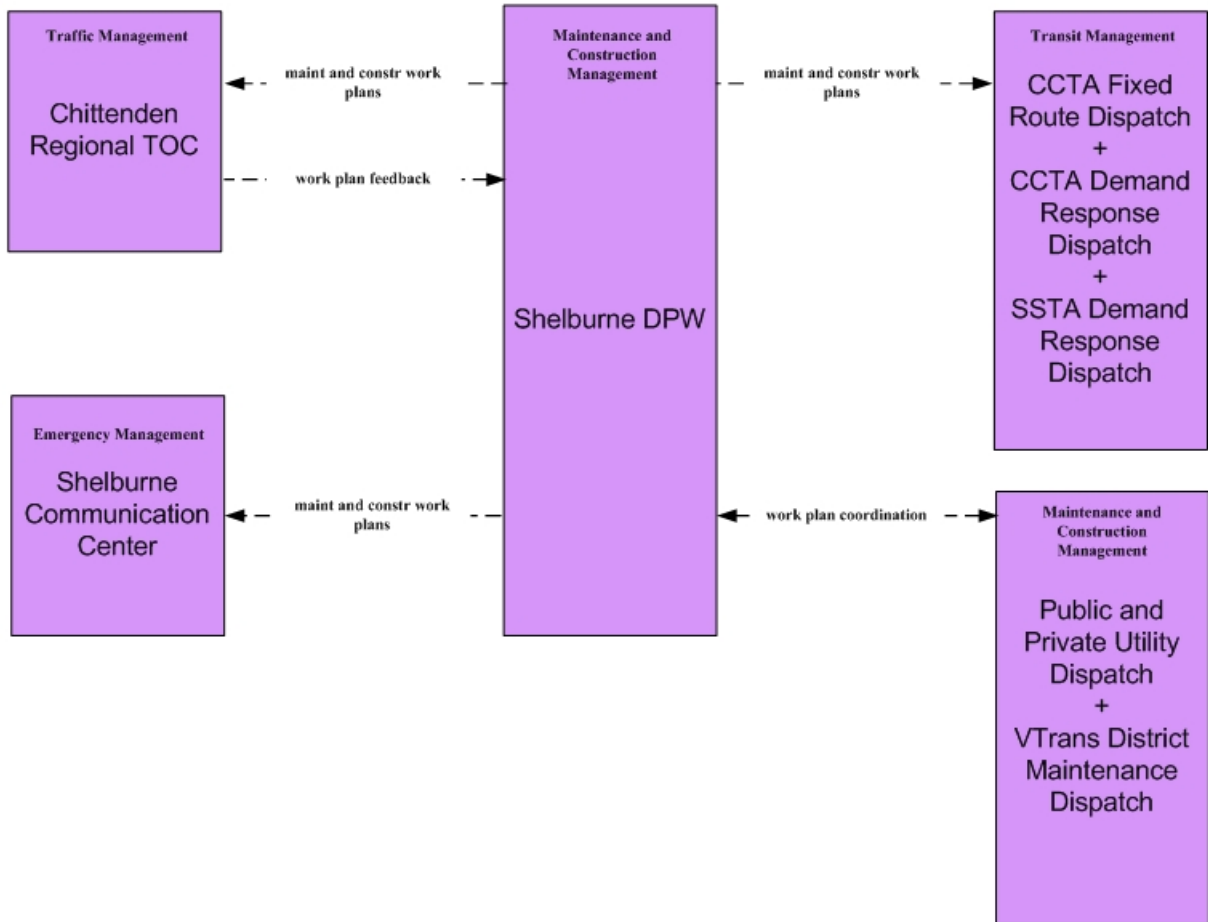

MC10 – Maintenance and Construction Activity Coordination
South Burlington DPW

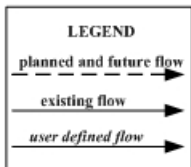
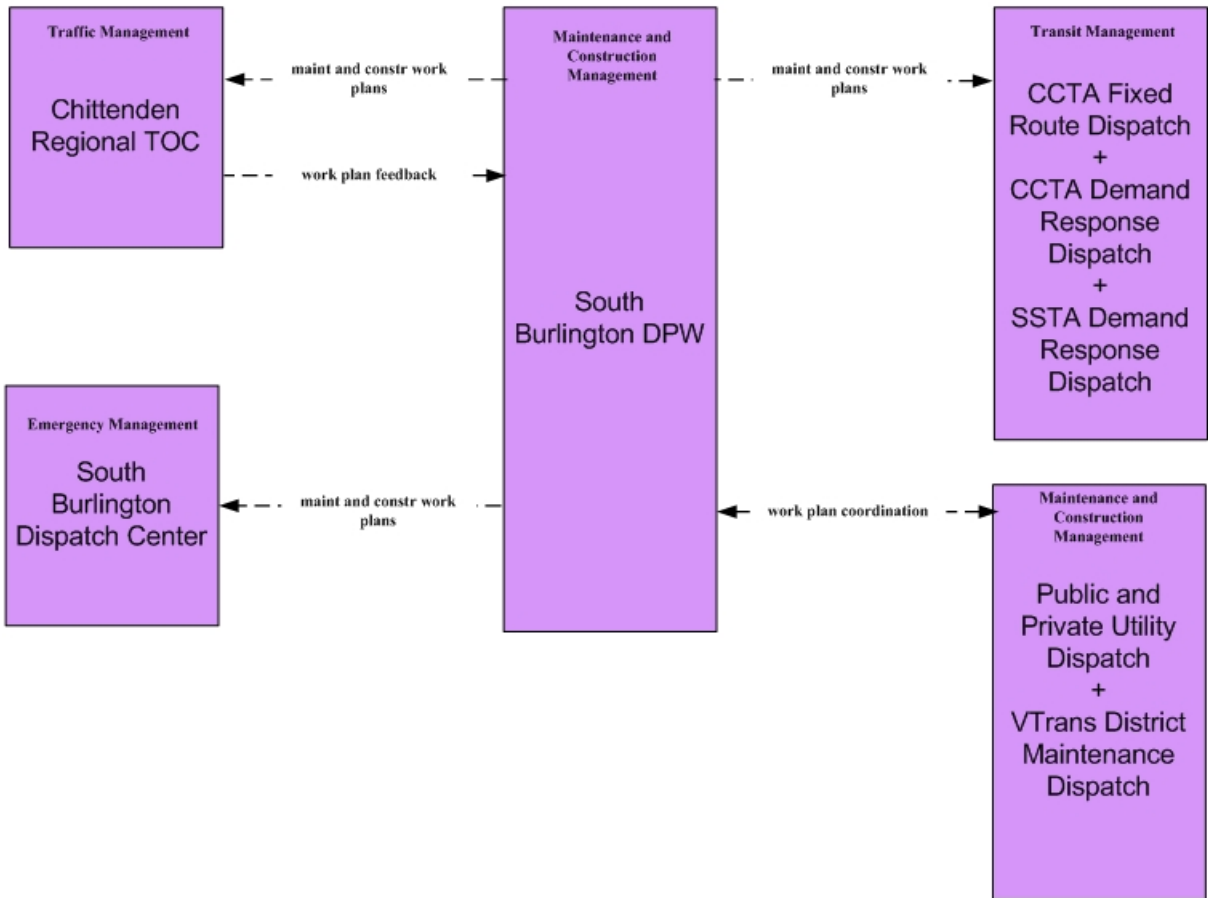

MC10 – Maintenance and Construction Activity Coordination
Williston DPW

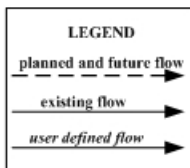
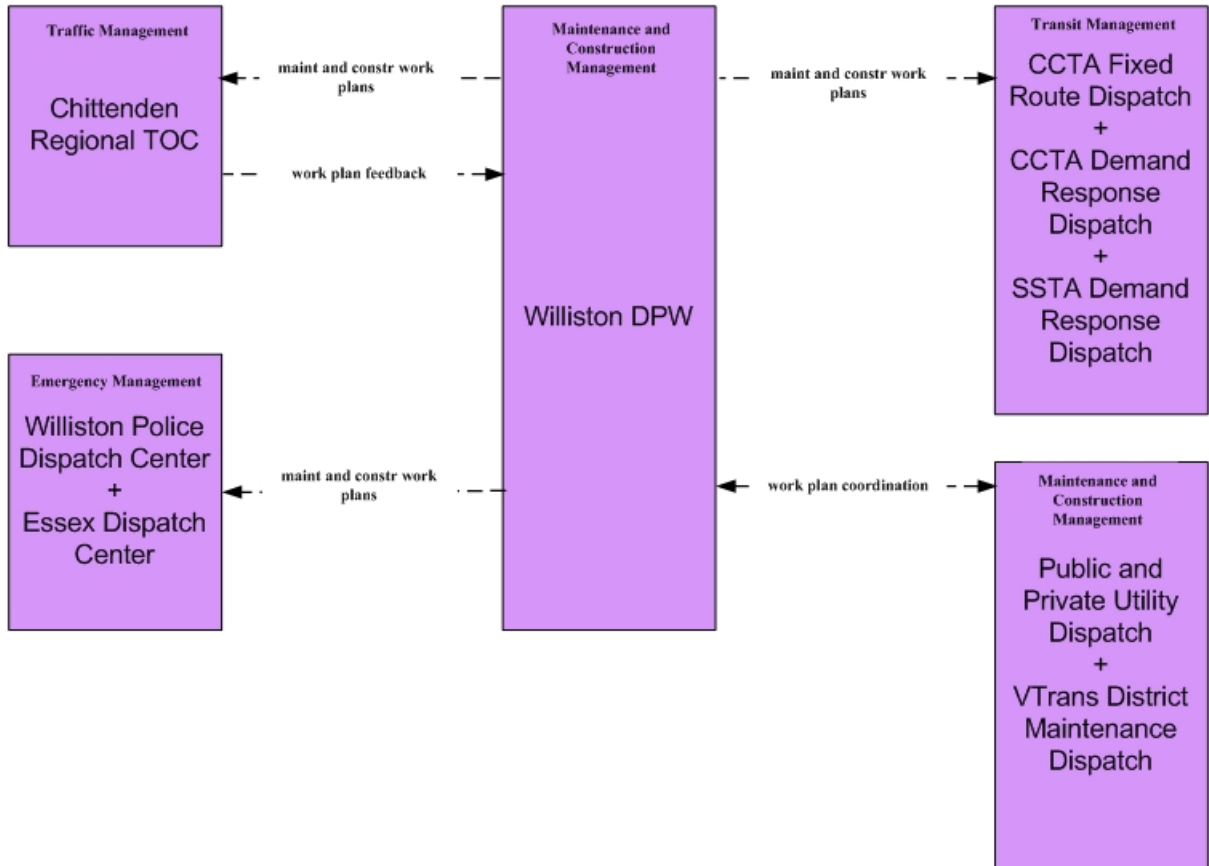

MC10 – Maintenance and Construction Activity Coordination
Winooski DPW

