

# AD1 - ITS Data Mart Essex Junction Data Repository

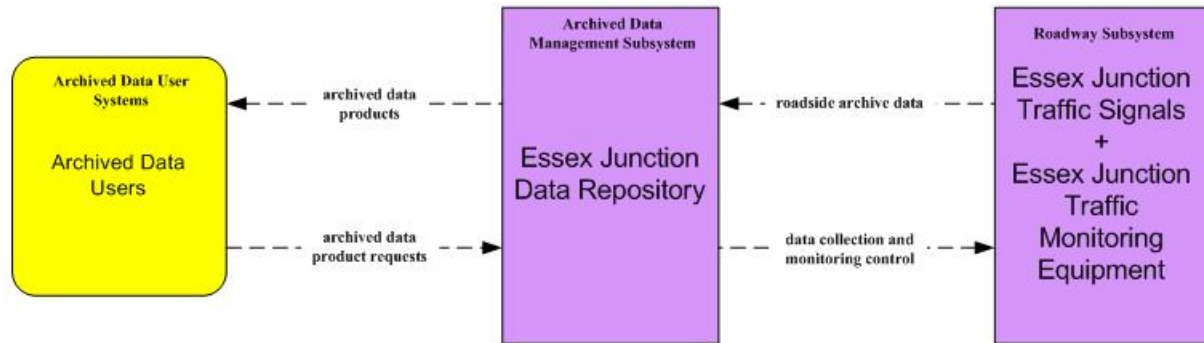

## LEGEND

*planned and future flow* →

*existing flow* →

*user defined flow* →

AD2 - ITS Data Warehouse  
CCMPO Data Warehouse

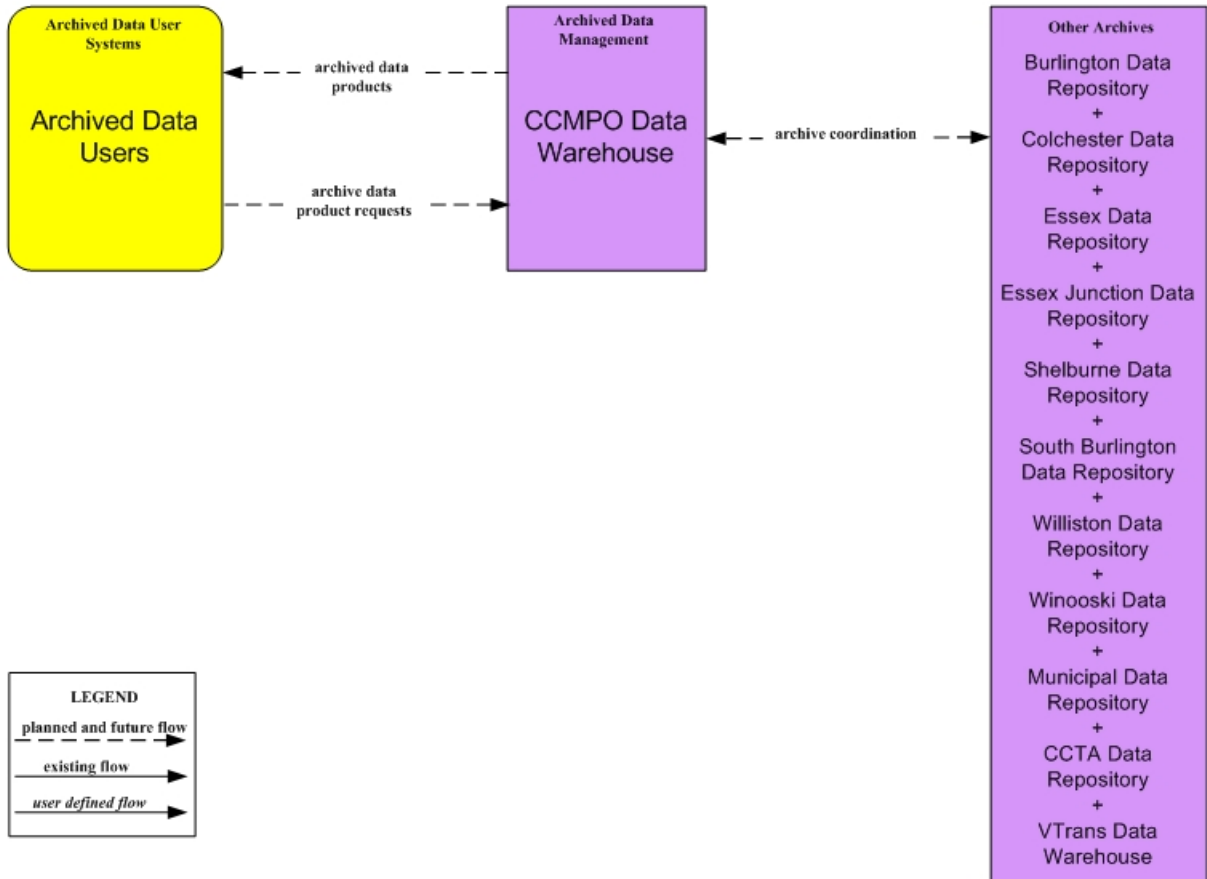

**APTS7 – Multimodal Coordination**  
**CCTA Fixed Route Dispatch – Chittenden Regional TOC and VTrans State TOC**

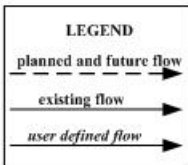
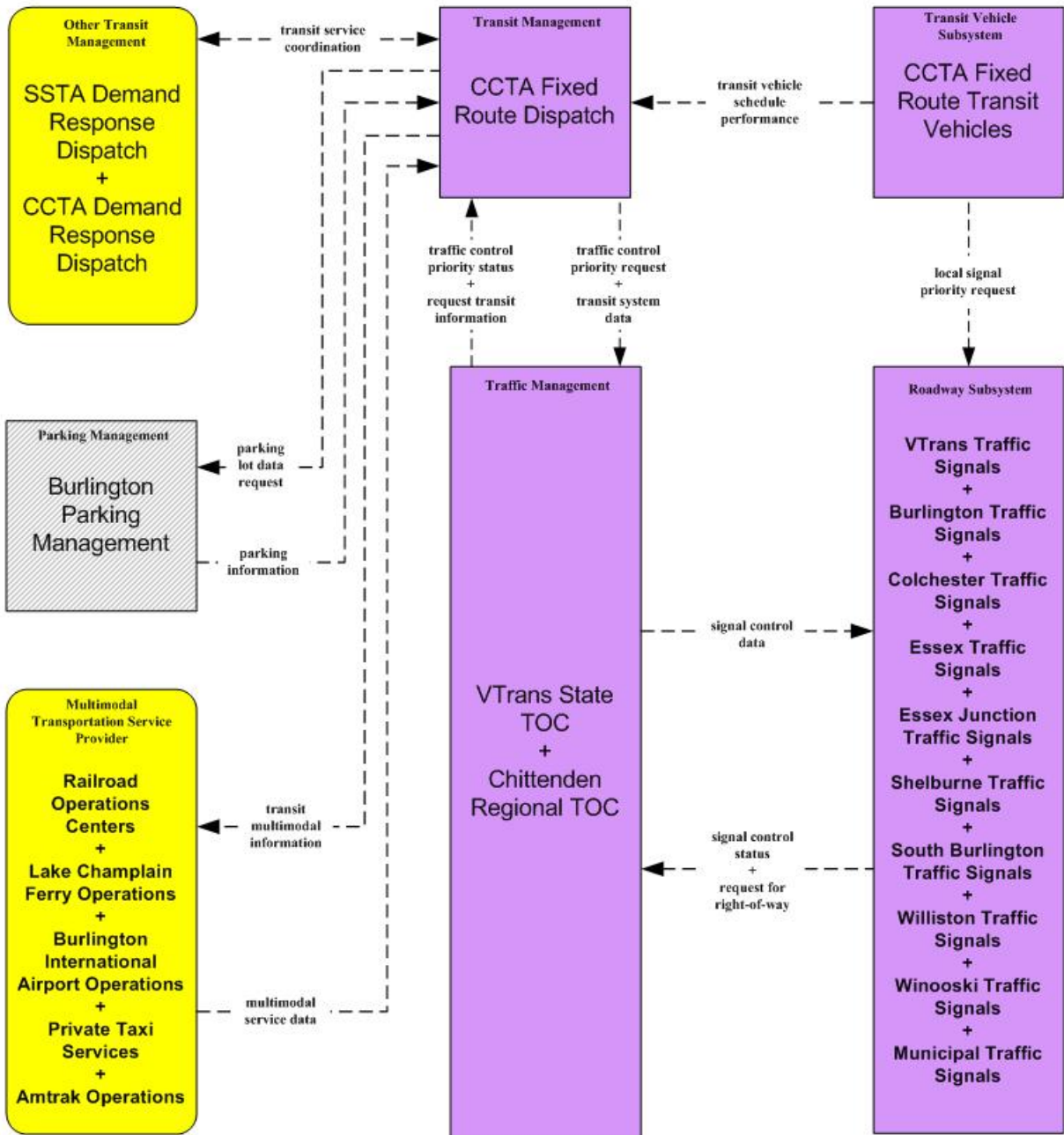

This market package instance is pending creation of the Chittenden Regional TOC. See the other APTS7 instance for details if it is not.

# APTS7 – Multimodal Coordination CCTA Fixed Route Dispatch

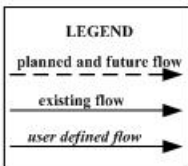
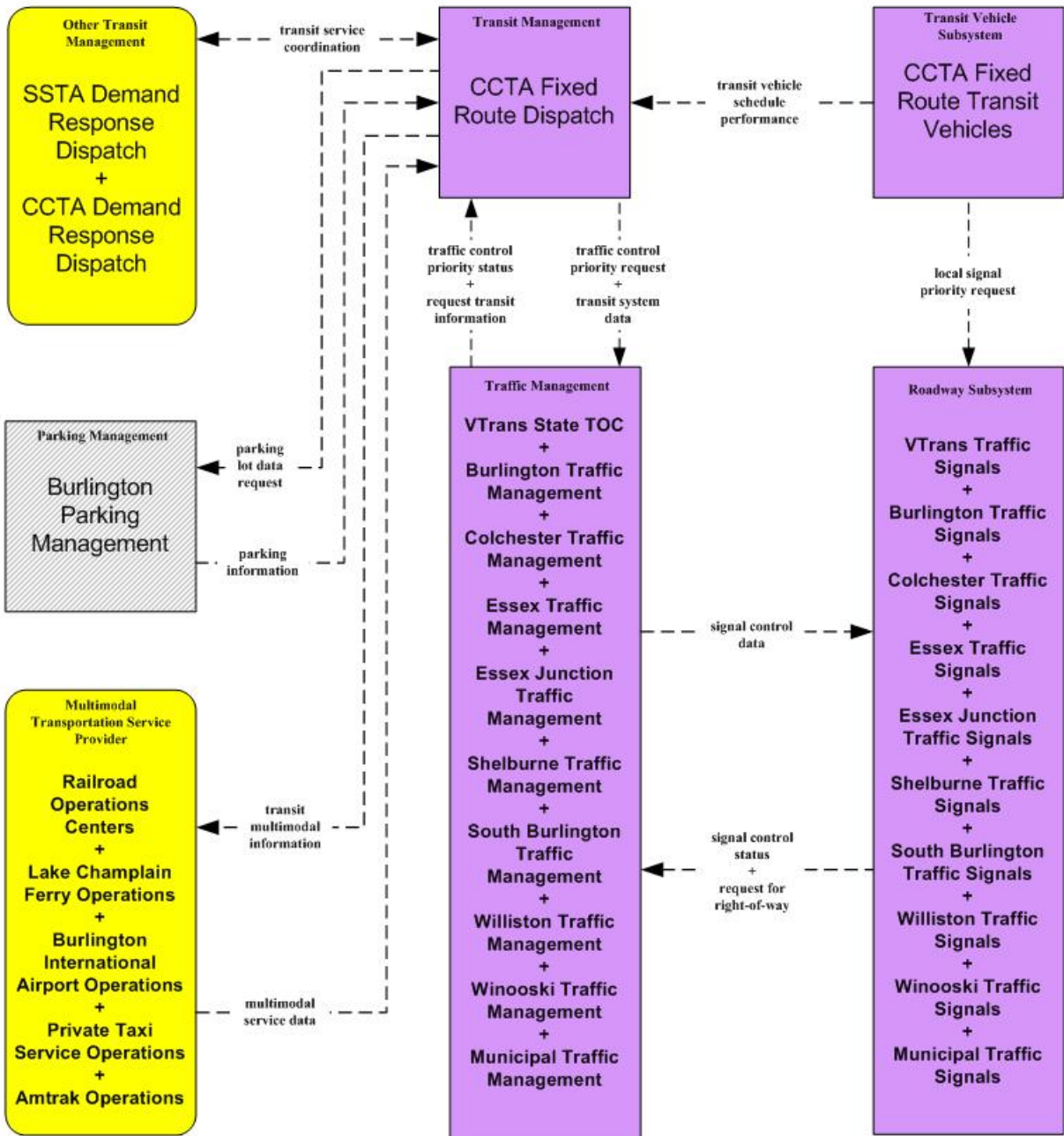

This market package instance is valid if the Chittenden Regional TOC is not created. See the APTS7 – Chittenden Regional TOC instance for details if it is.

# ATIS1 - Broadcast Traveler Information CARS Information System

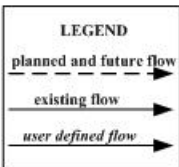
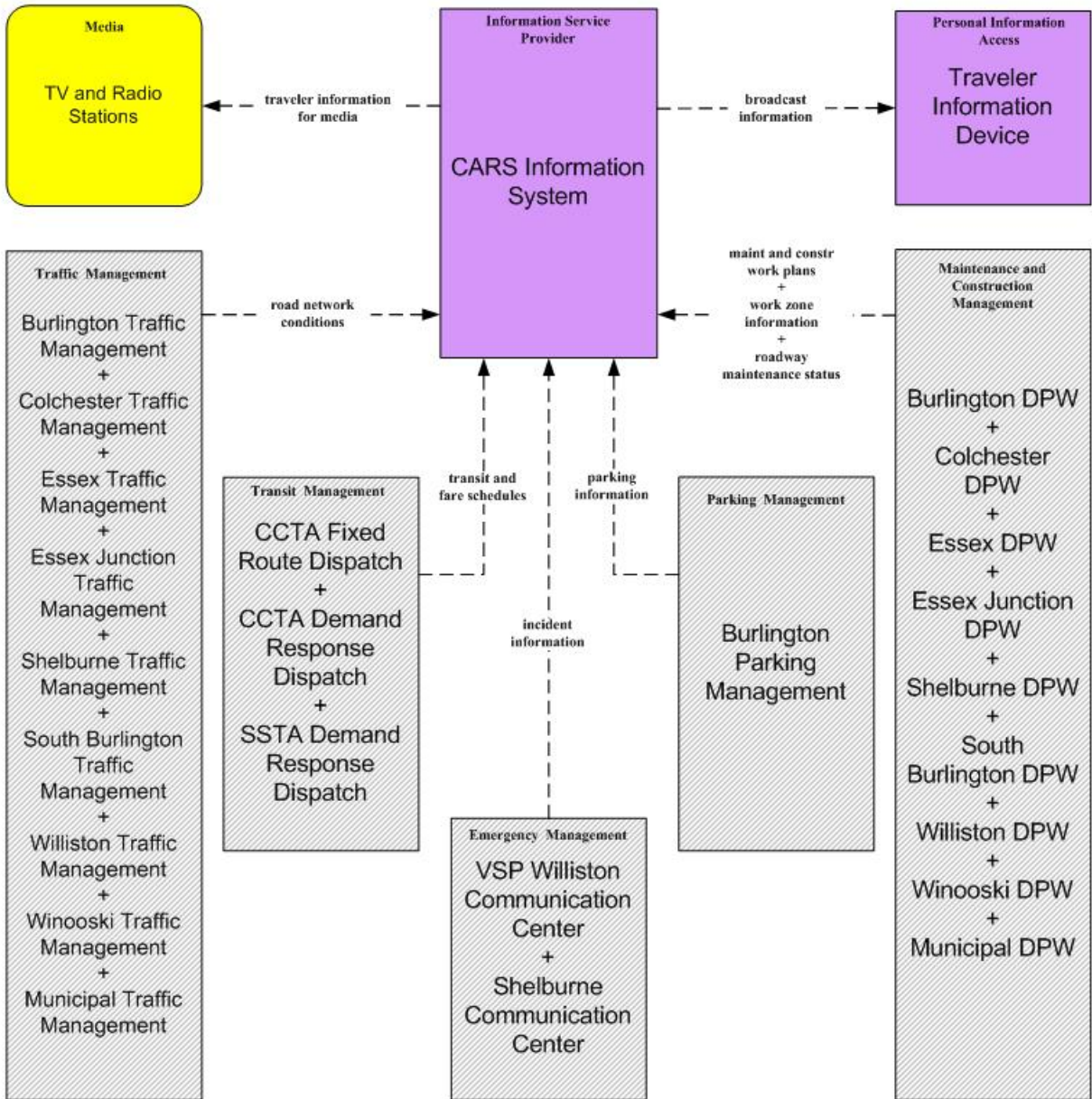

This market package instance is valid if the Chittenden Regional TOC is not created. See the ATIS1 – CARS – Chittenden Regional TOC instance for details if it is.

ATIS1 - Broadcast Traveler Information  
 CARS Information System – Chittenden Regional TOC

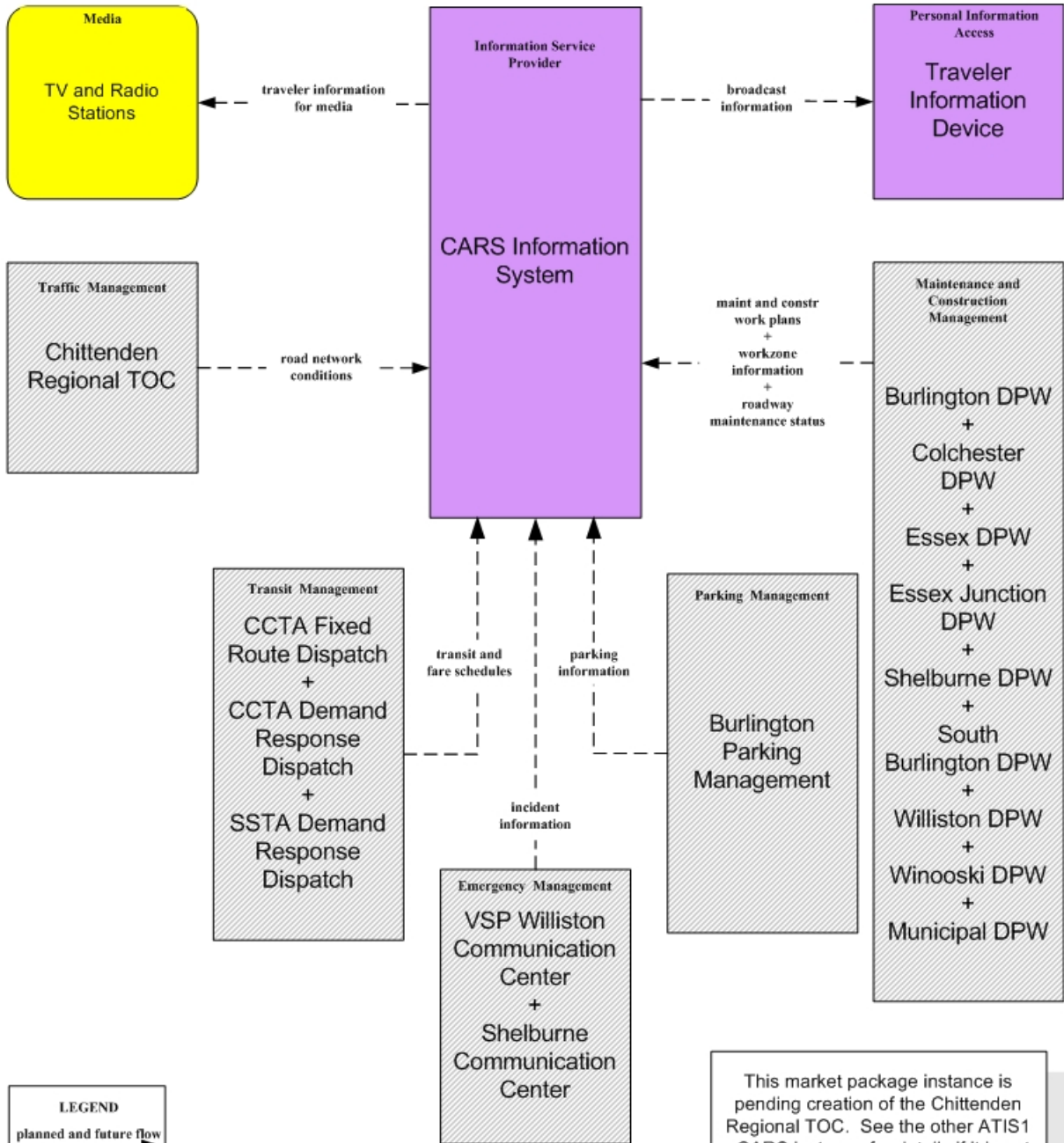

**LEGEND**

planned and future flow →

existing flow →

user defined flow →

This market package instance is pending creation of the Chittenden Regional TOC. See the other ATIS1 – CARS instance for details if it is not.

# ATIS1 - Broadcast Traveler Information Essex Junction Website

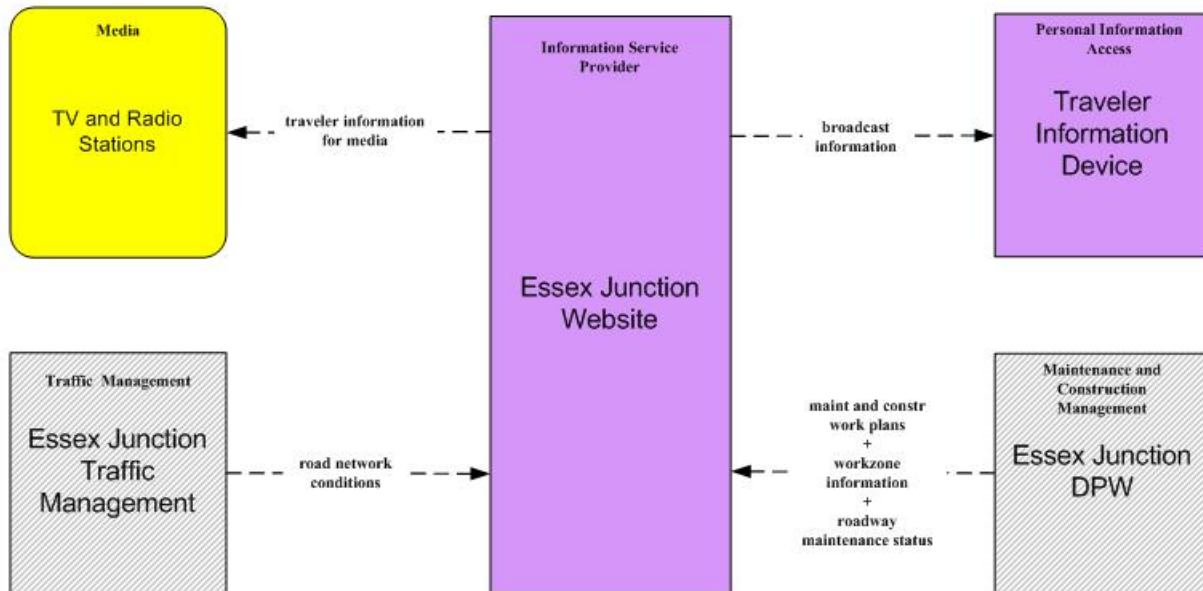

## LEGEND

planned and future flow →

existing flow →

*user defined flow* →

# ATMS01 - Network Surveillance Essex Junction Traffic Management

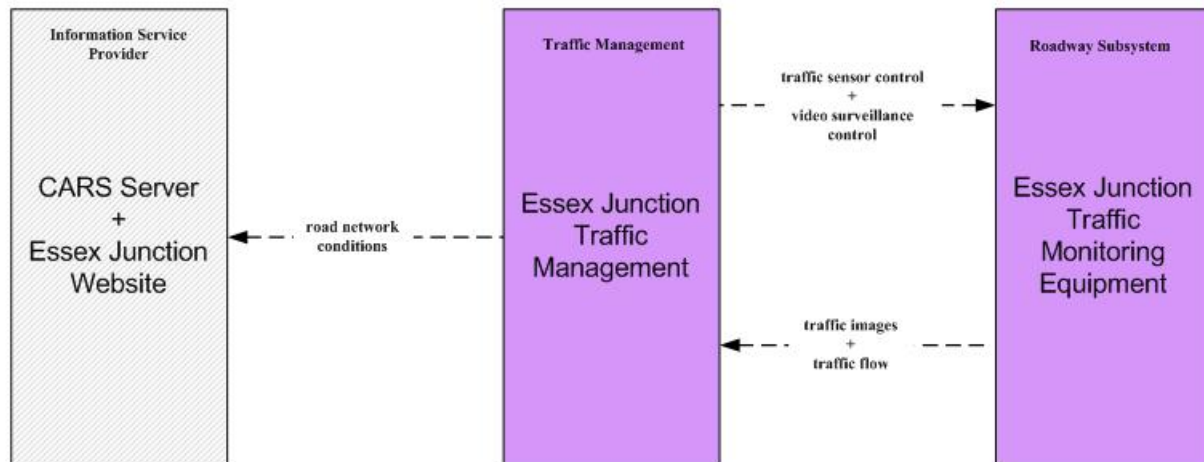

## LEGEND

planned and future flow

existing flow

user defined flow



ATMS03 - Surface Street Control  
Essex Junction Traffic Management

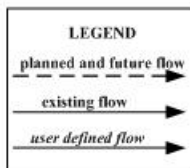
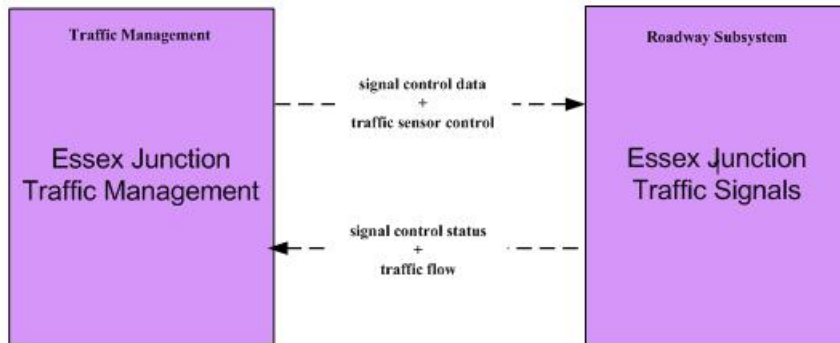

**ATMS06 – Traffic Information Dissemination  
Chittenden Regional TOC (Future)**

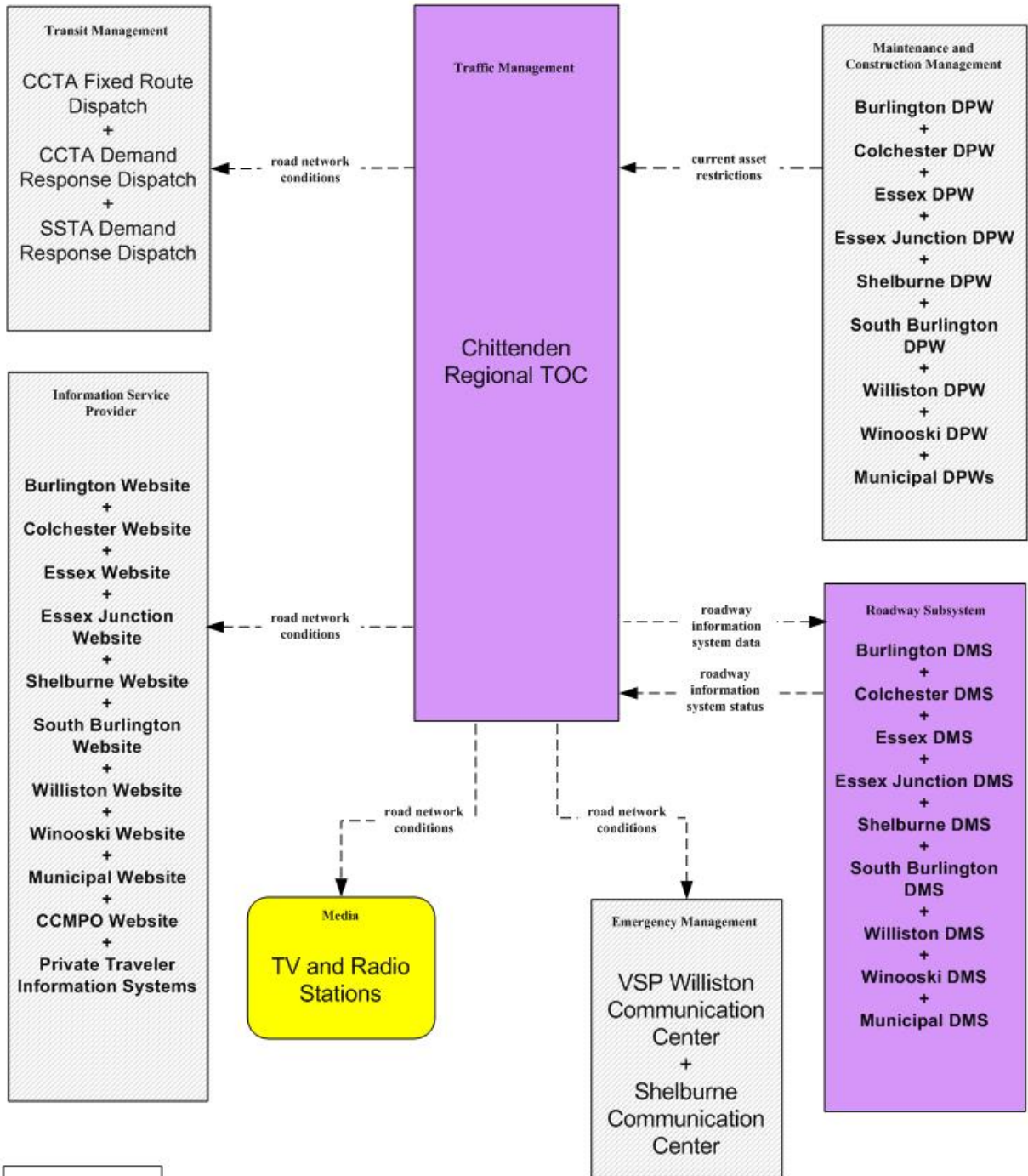

ATMS06 – Traffic Information Dissemination  
Essex Junction Traffic Management

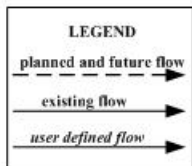
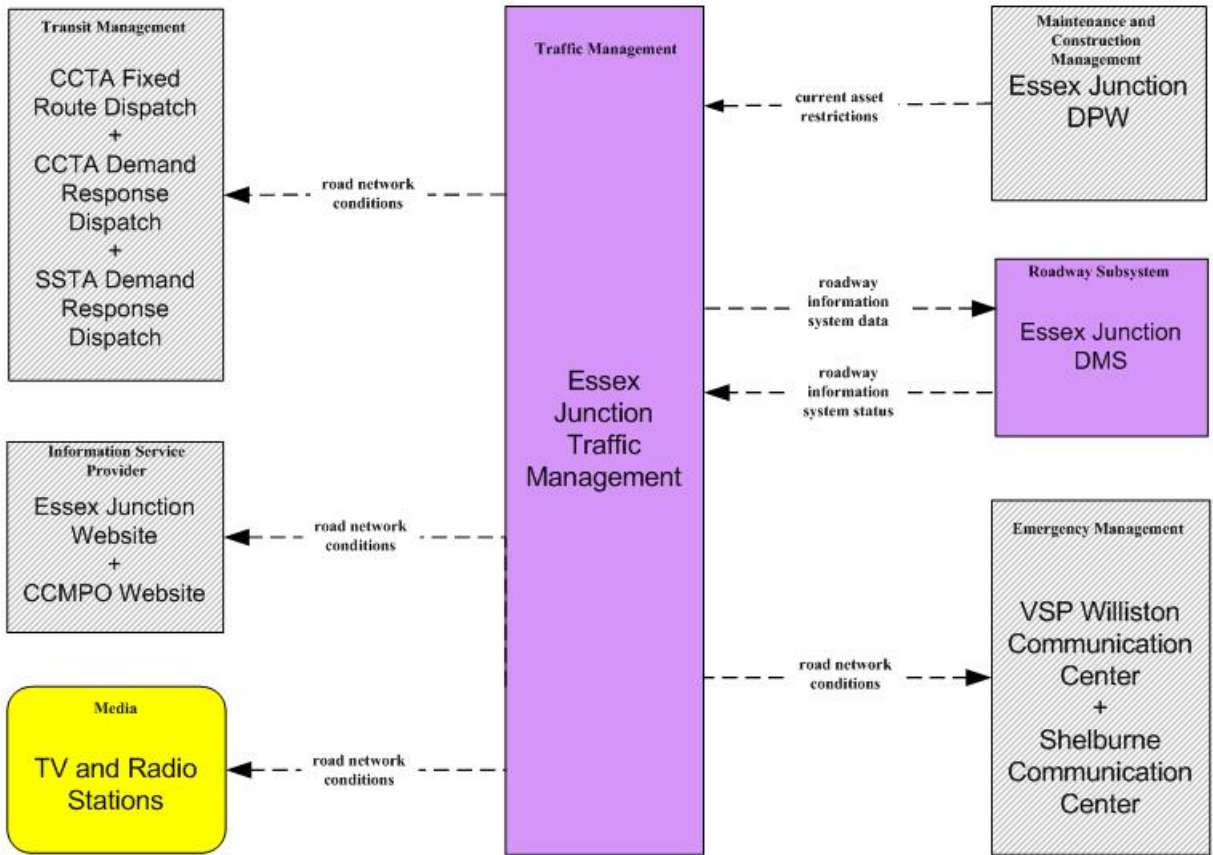

ATMS07 – Regional Traffic Control  
Chittenden Regional TOC

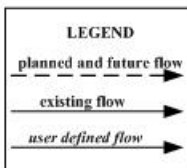
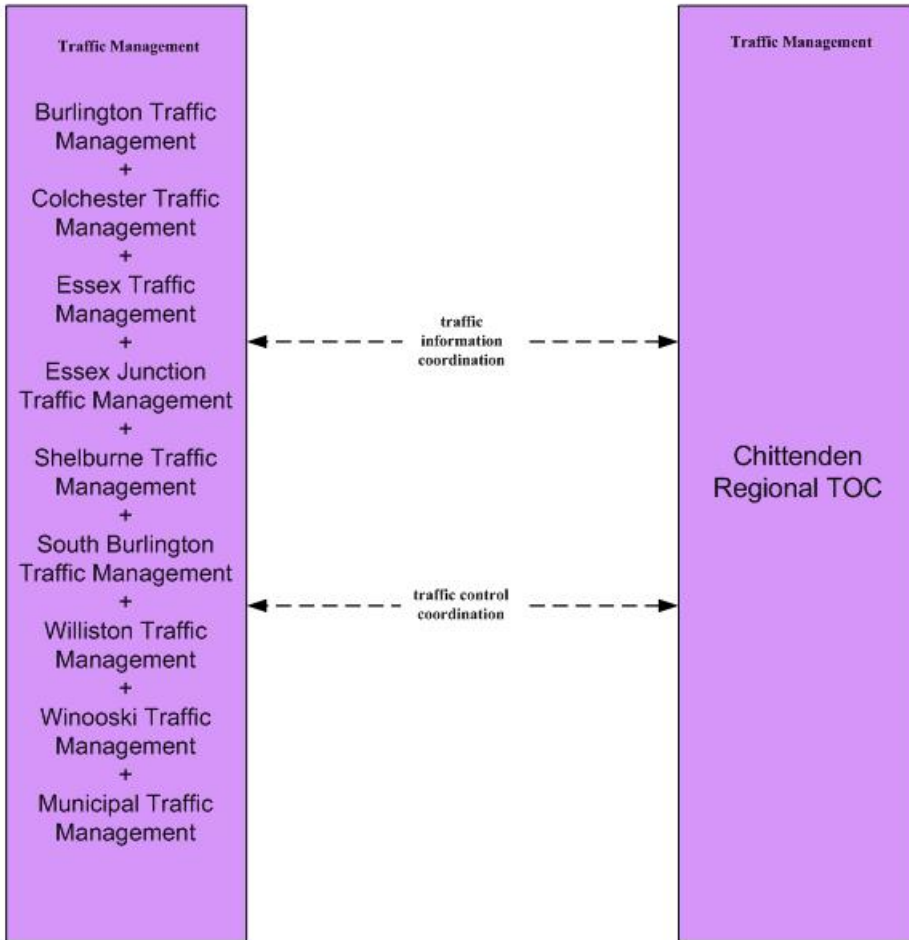

ATMS08 – Incident Management  
Chittenden Regional TOC

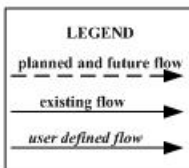
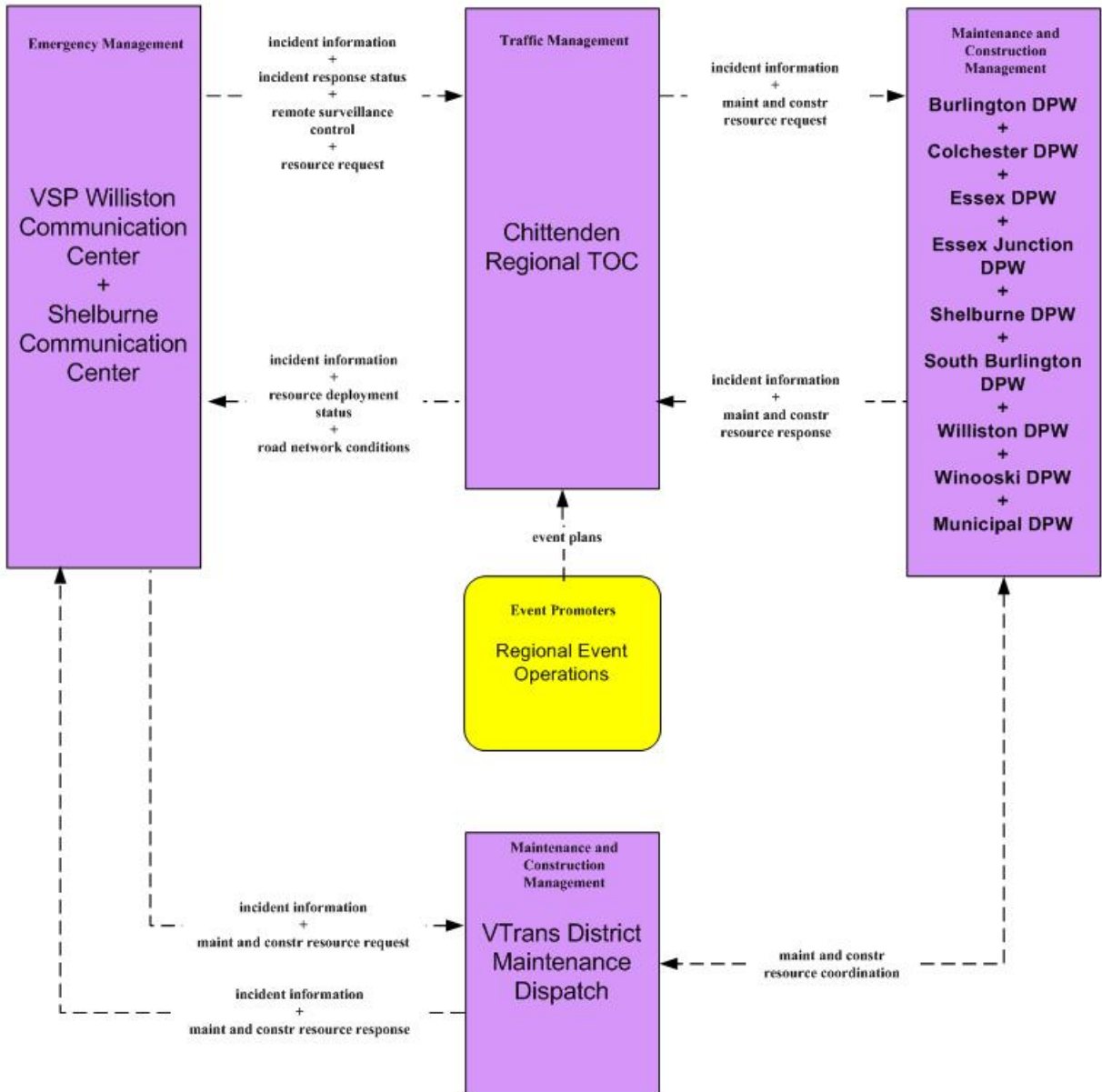

# ATMS08 – Incident Management Essex Junction Traffic Management

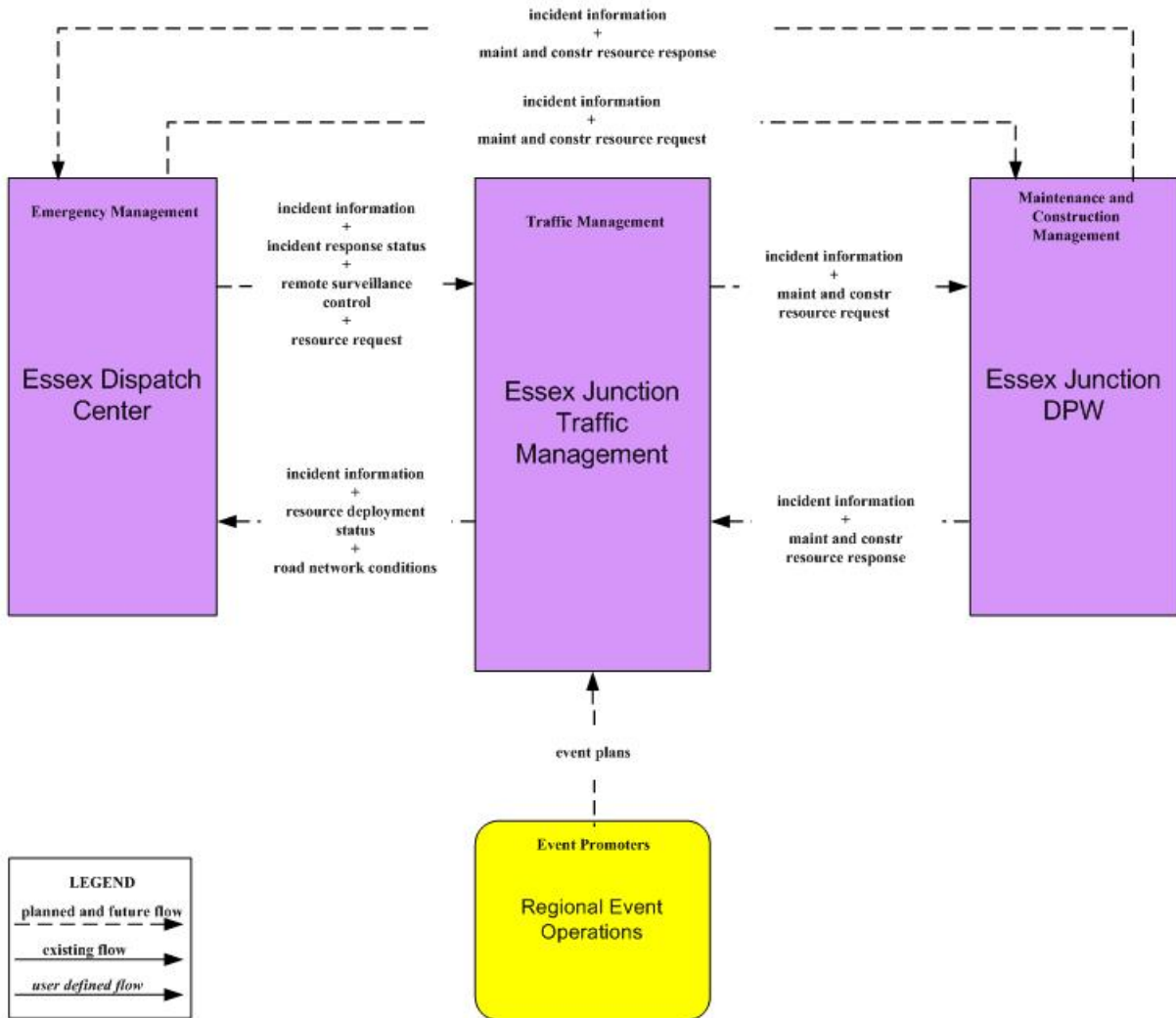

**ATMS13 - Standard Railroad Grade Crossing  
Chittenden Regional Traffic Operations Center (Future)**

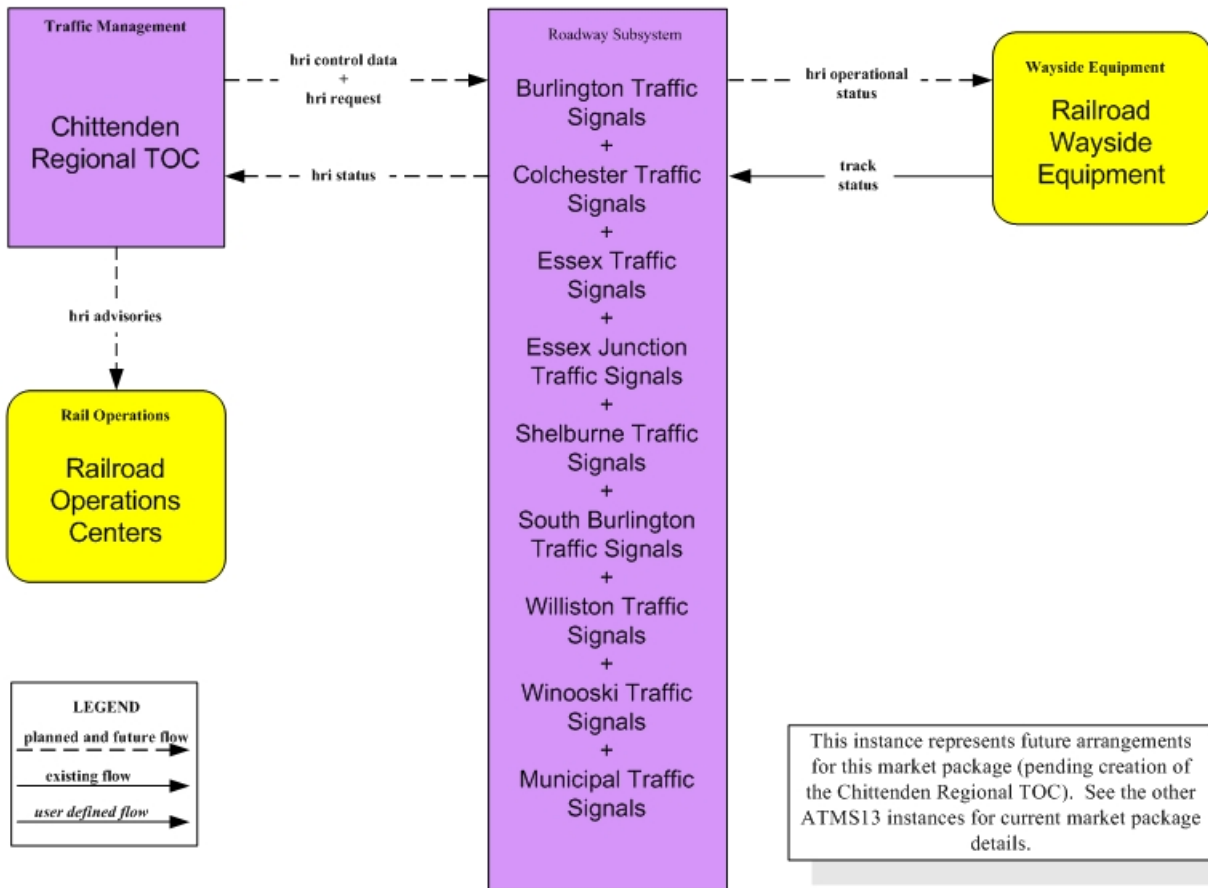

ATMS13 - Standard Railroad Grade Crossing  
Essex Junction Traffic Management

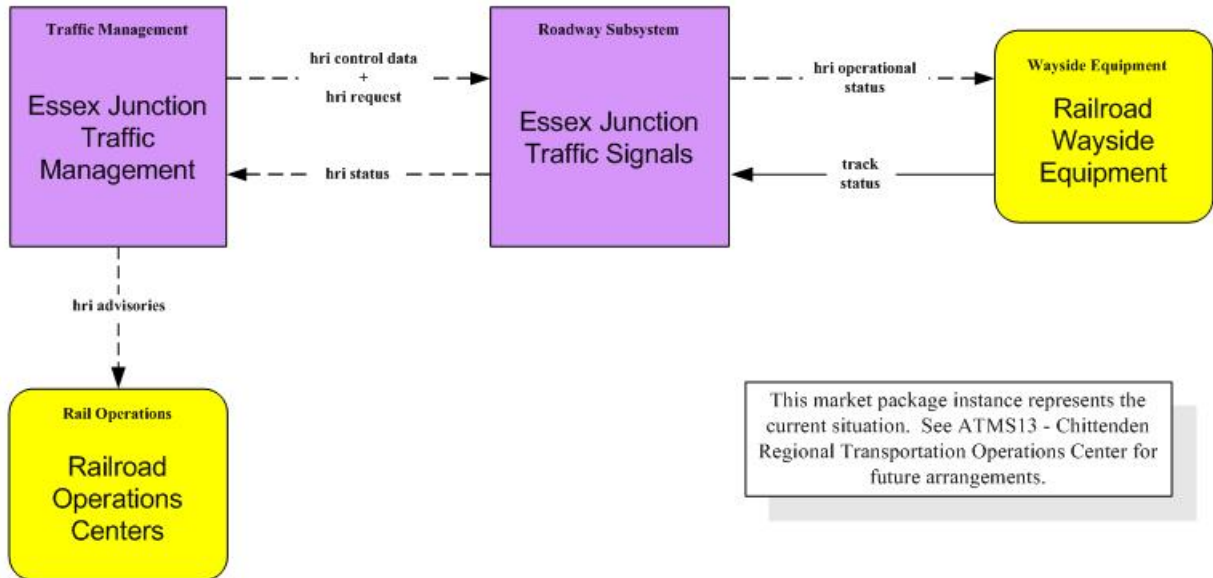

This market package instance represents the current situation. See ATMS13 - Chittenden Regional Transportation Operations Center for future arrangements.

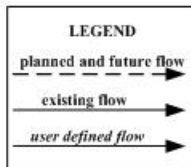



# ATMS15 – Railroad Operations Coordination

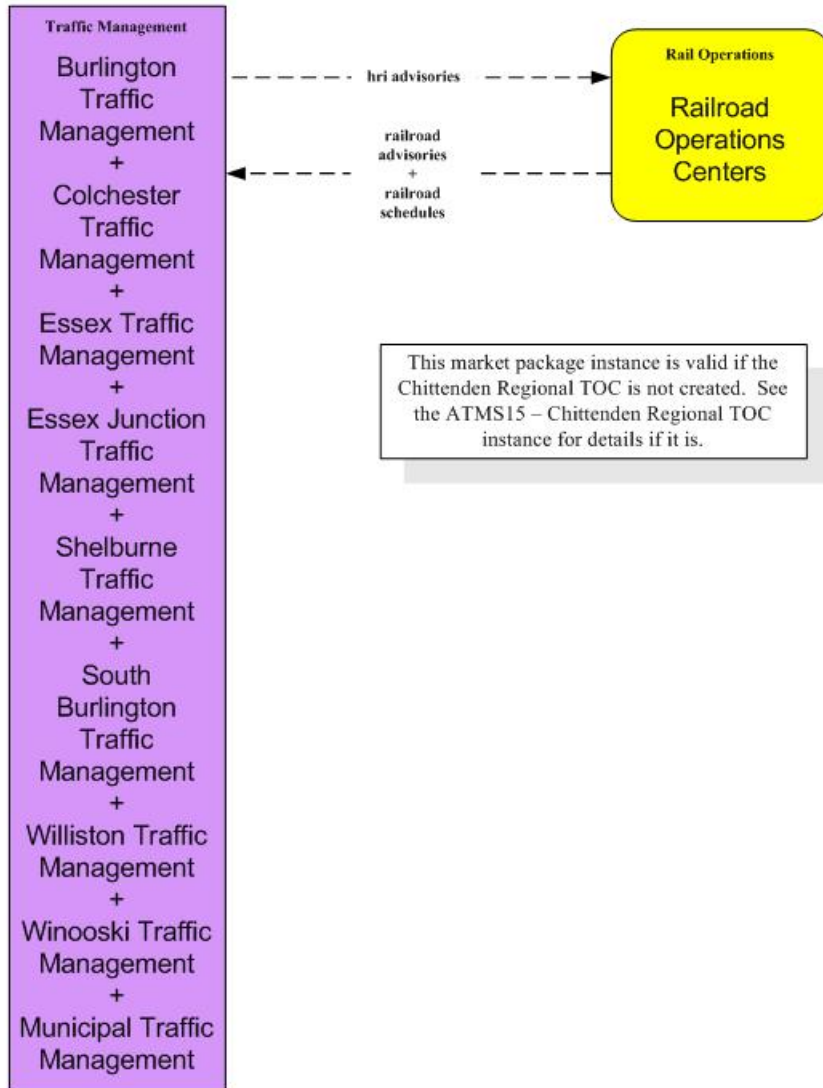

This market package instance is valid if the Chittenden Regional TOC is not created. See the ATMS15 – Chittenden Regional TOC instance for details if it is.

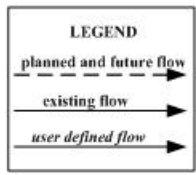

EMO2 – Emergency Routing  
1 of 2 - Chittenden Regional TOC

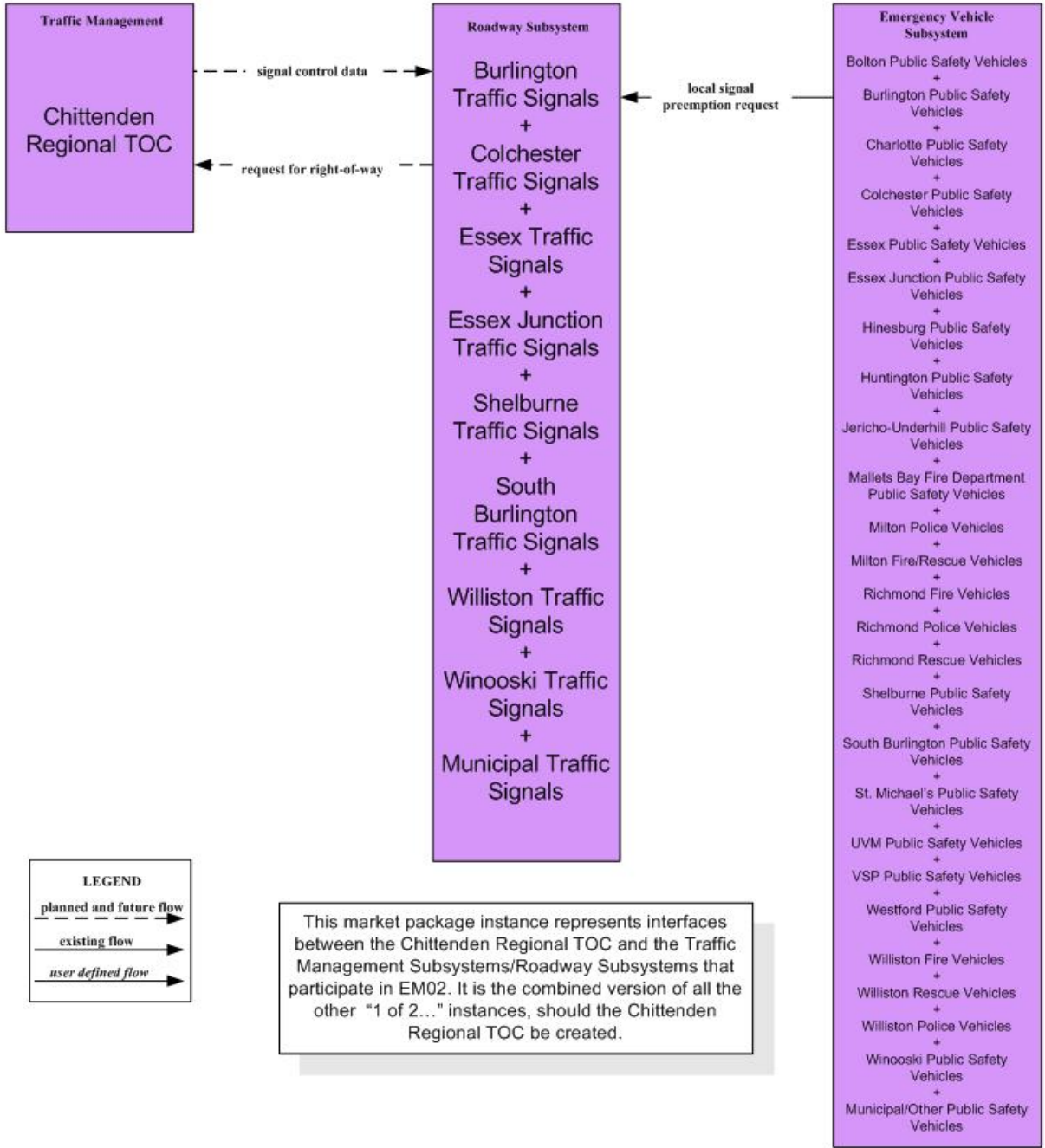

# EMO2 – Emergency Routing

## 1 of 2 - Essex Junction

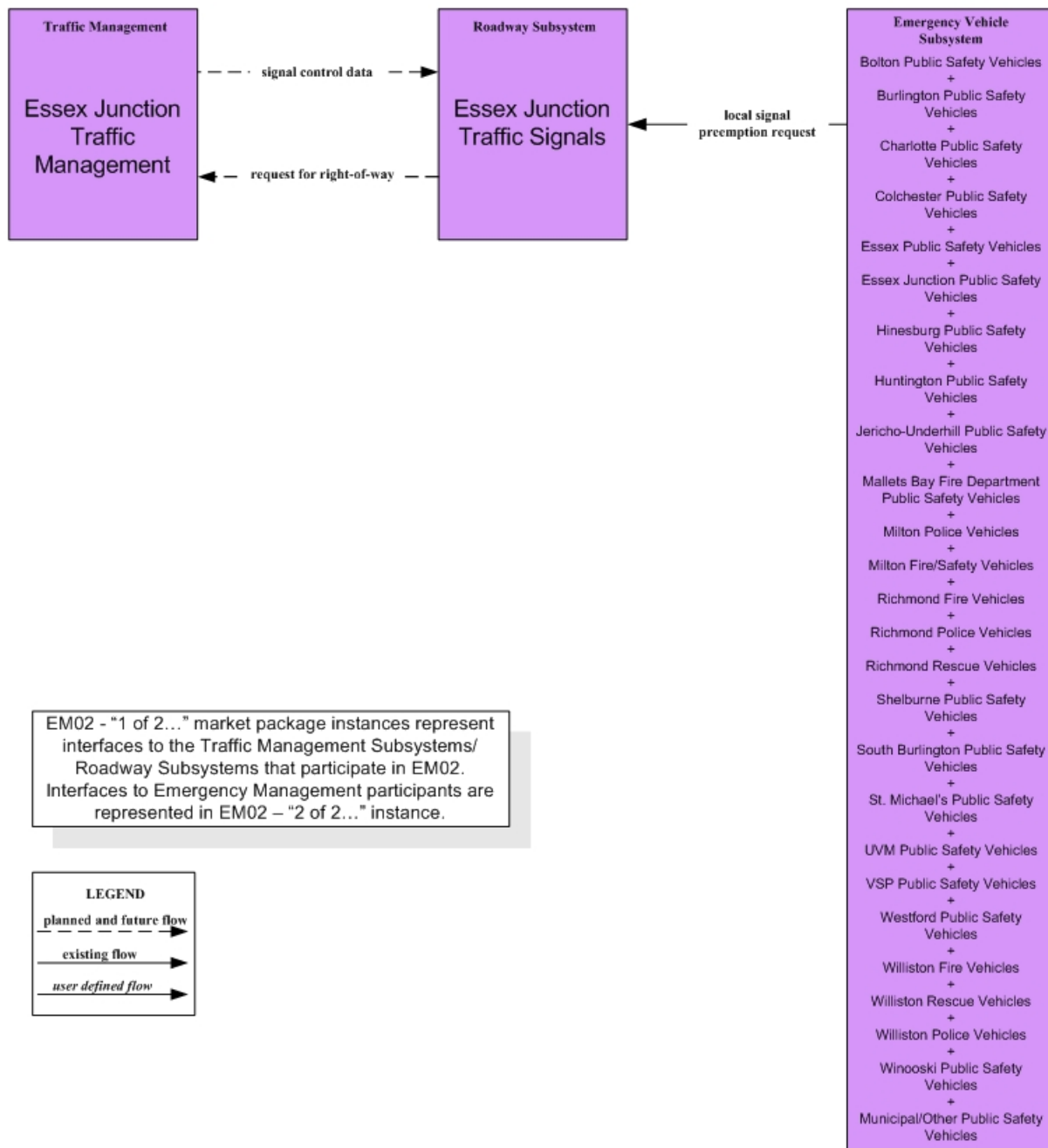

# EMO2 – Emergency Routing

## 2 of 2 – Emergency Management

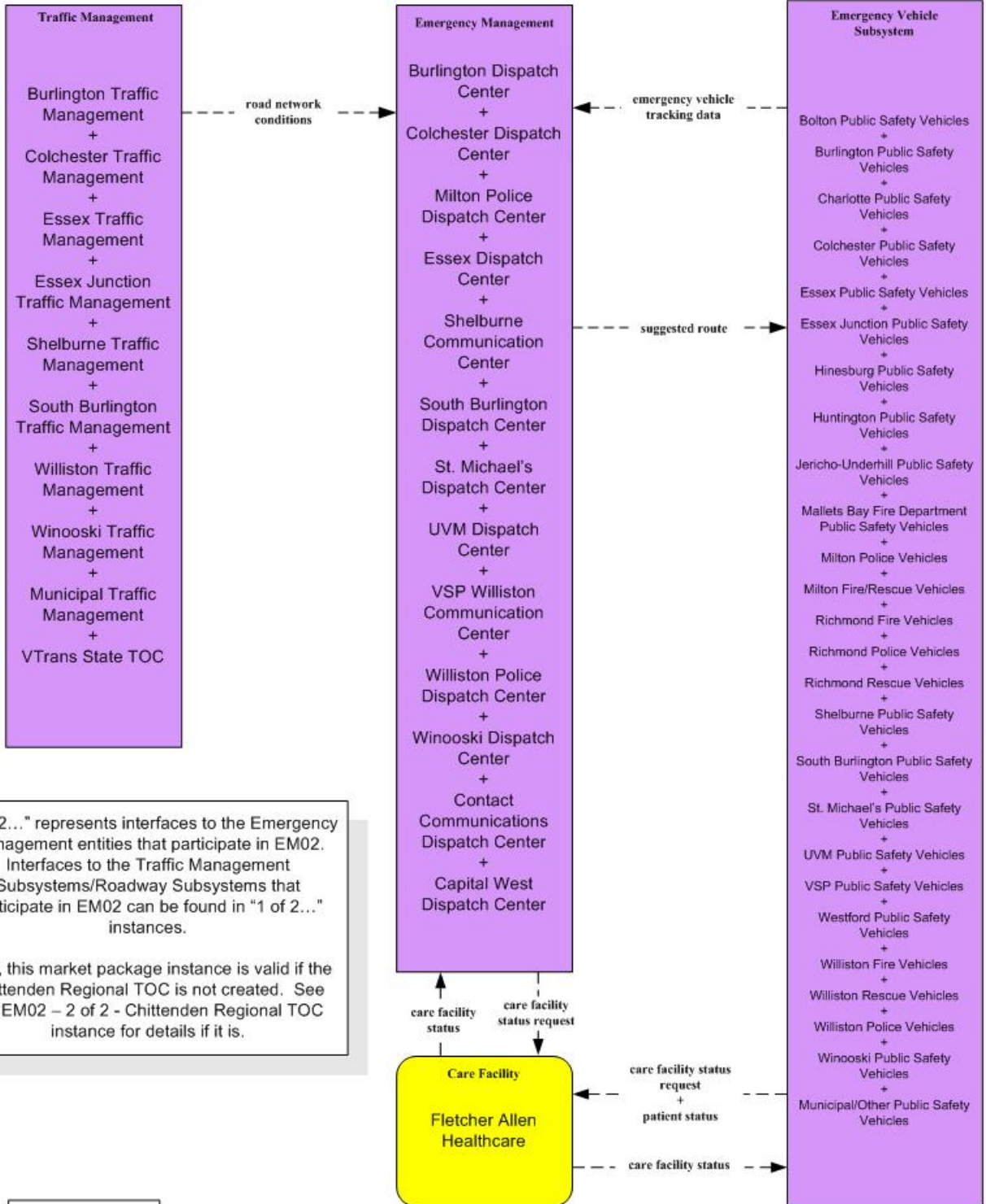

"2 of 2..." represents interfaces to the Emergency Management entities that participate in EM02. Interfaces to the Traffic Management Subsystems/Roadway Subsystems that participate in EM02 can be found in "1 of 2..." instances.

Also, this market package instance is valid if the Chittenden Regional TOC is not created. See the EM02 – 2 of 2 - Chittenden Regional TOC instance for details if it is.

**EMO6 – Wide Area Alert  
Vermont Statewide EOC & VSP Headquarters**

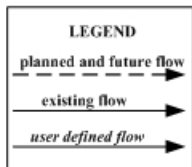
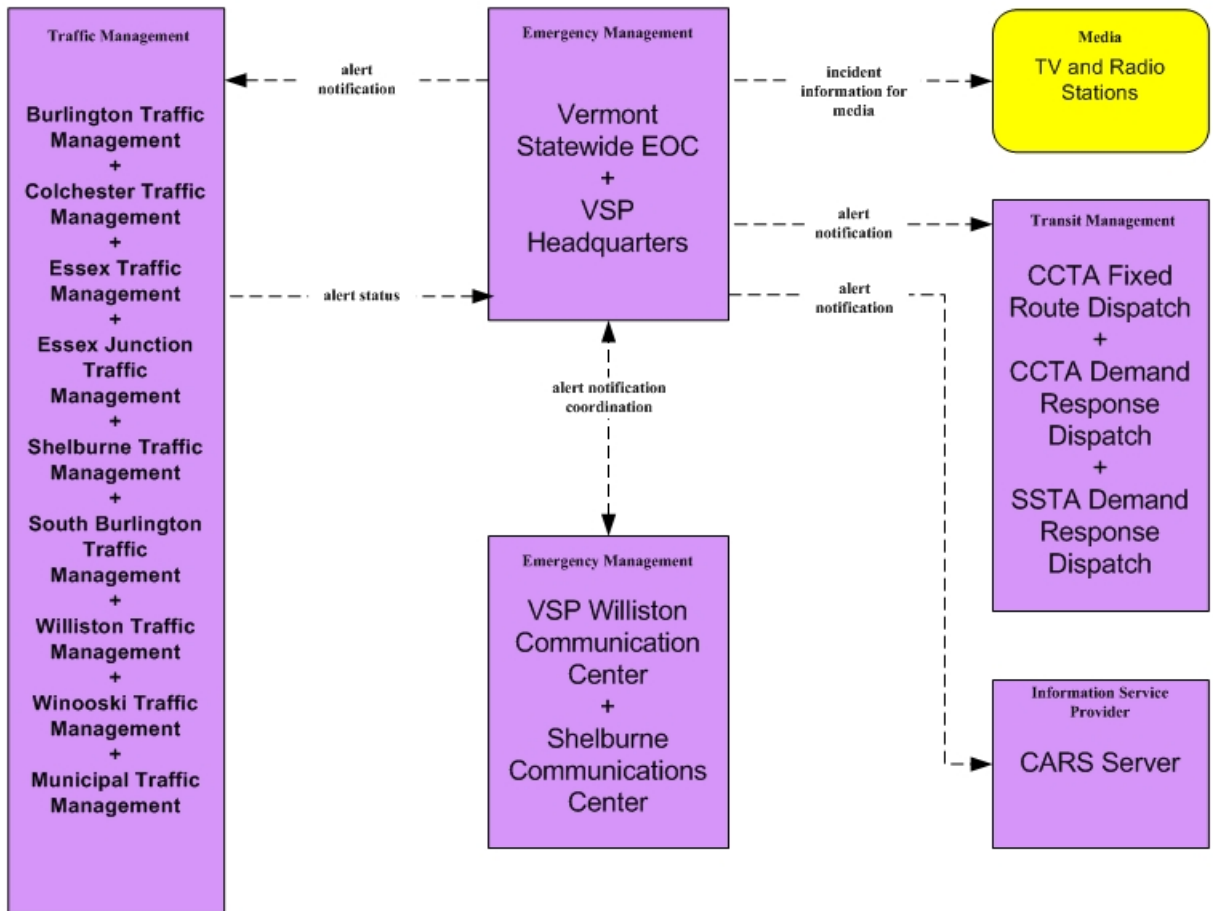

EM09 - Evacuation and Reentry Management  
Vermont Statewide EOC

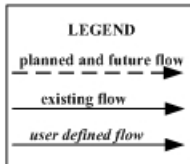
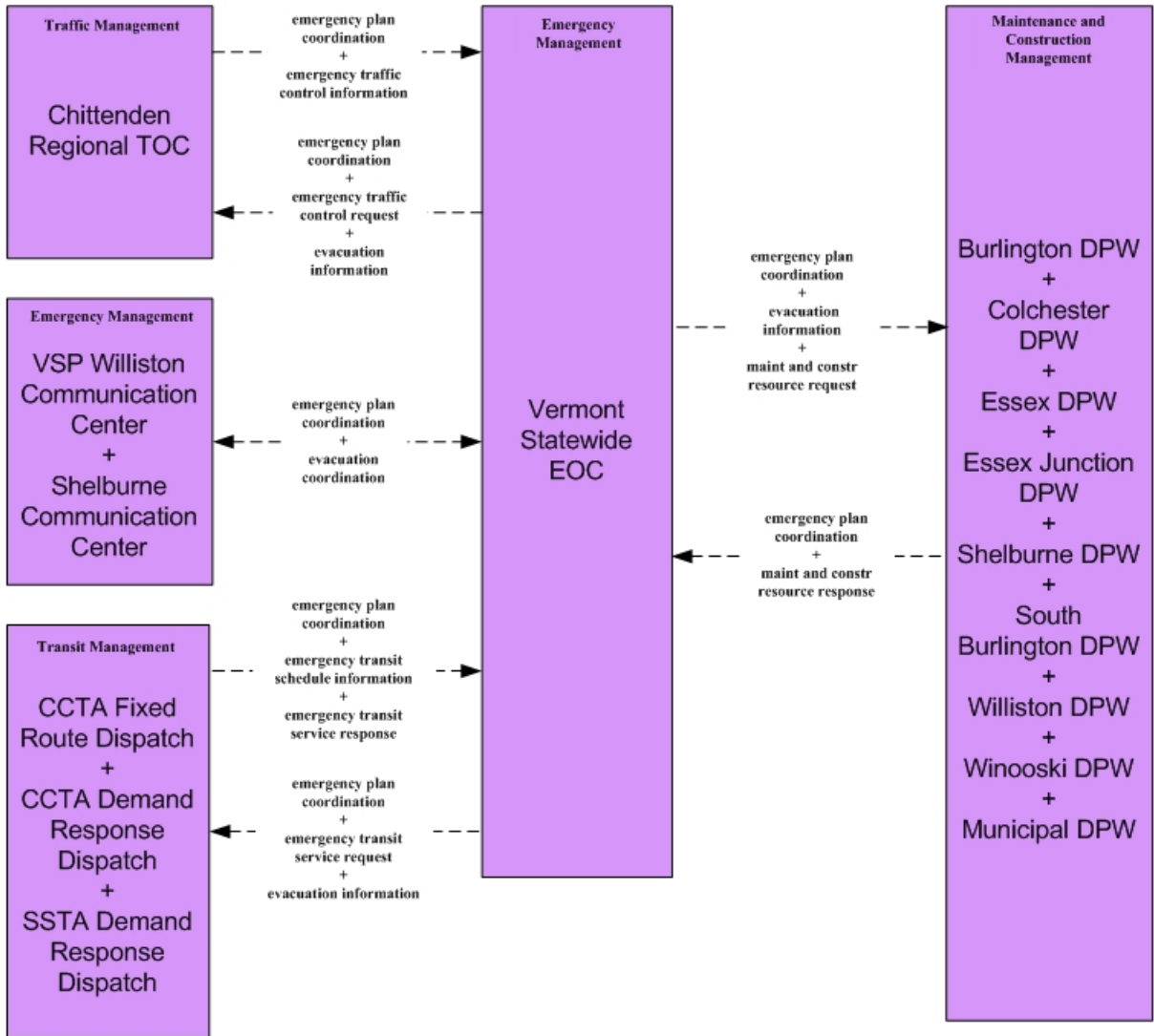

MC01 – Maintenance and Construction Vehicle Tracking  
Essex Junction DPW

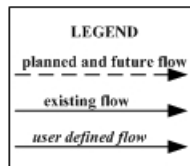
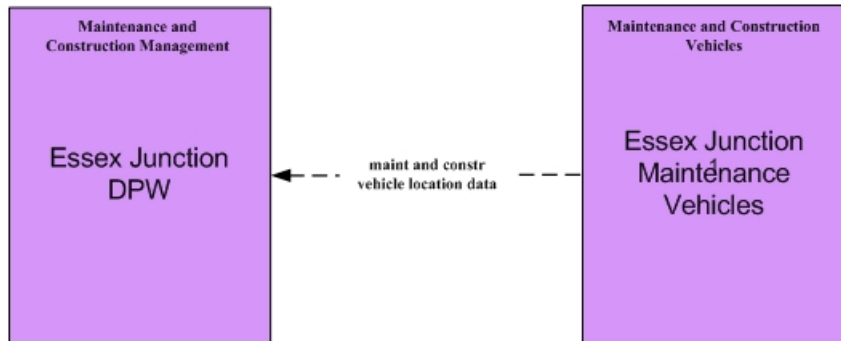

MC02 – Maintenance and Construction Vehicle Maintenance  
Essex Junction DPW

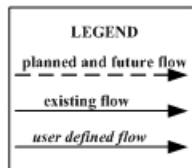
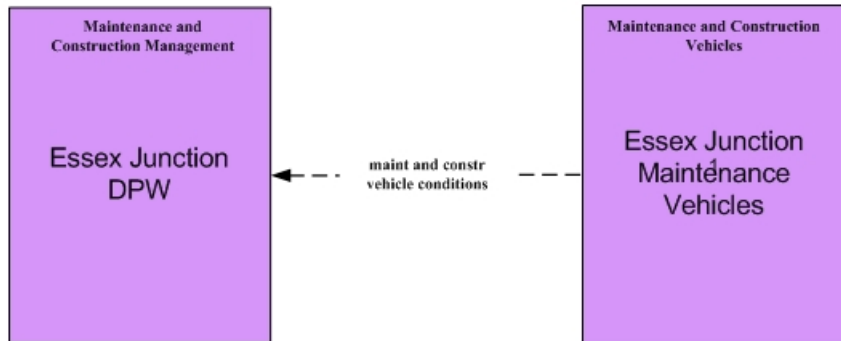



MC04 - Weather Information Processing and Distribution  
Weather Services

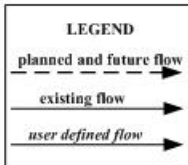
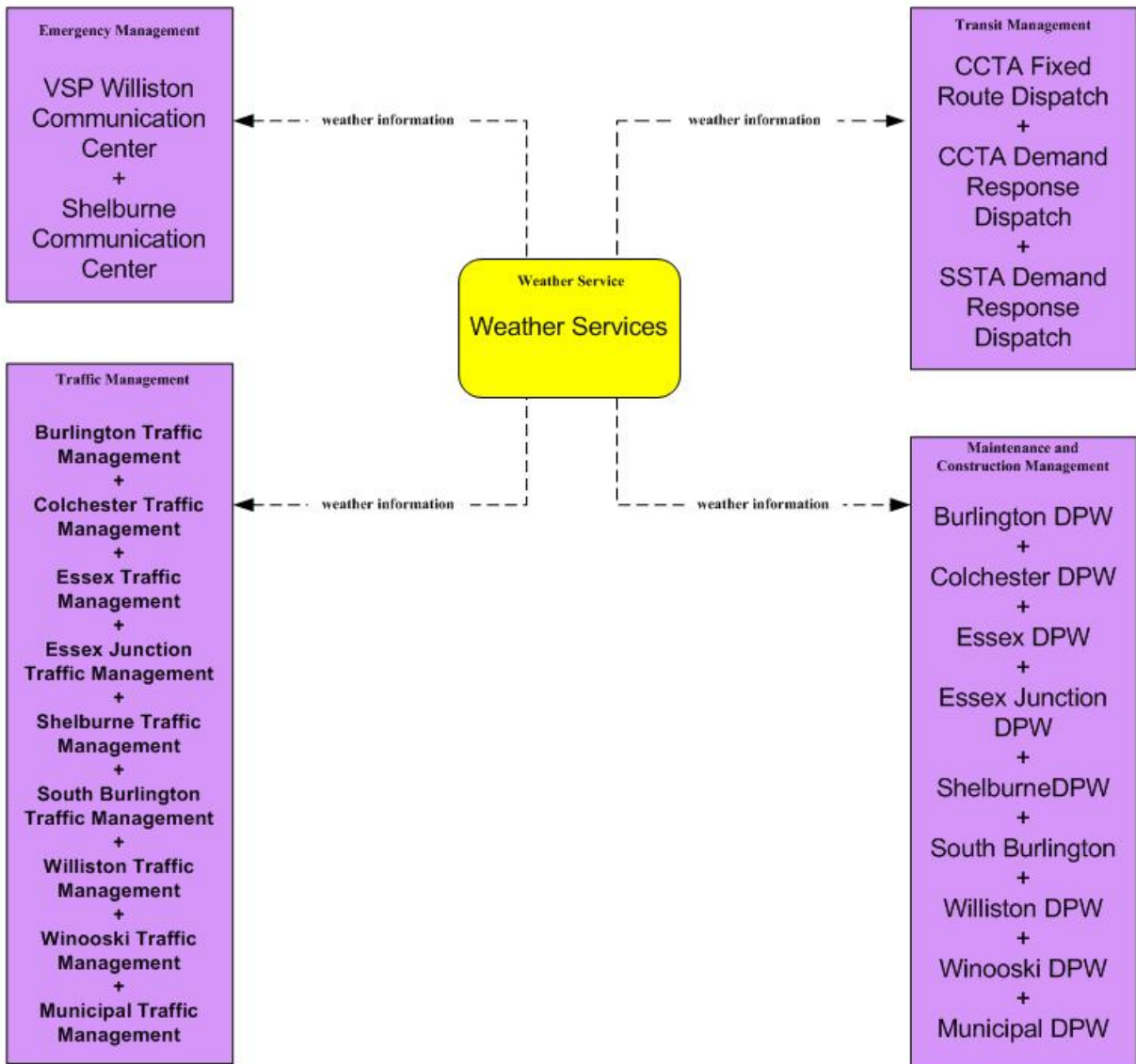

This instance represents the situation for this market package with existing entities only. See the MC04 – Weather Services (Chittenden Regional TOC) instance for market package details pending creation of the Chittenden Regional TOC.

MC04 - Weather Information Processing and Distribution  
Weather Services – Chittenden Regional TOC

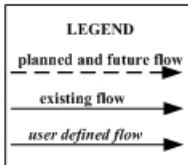
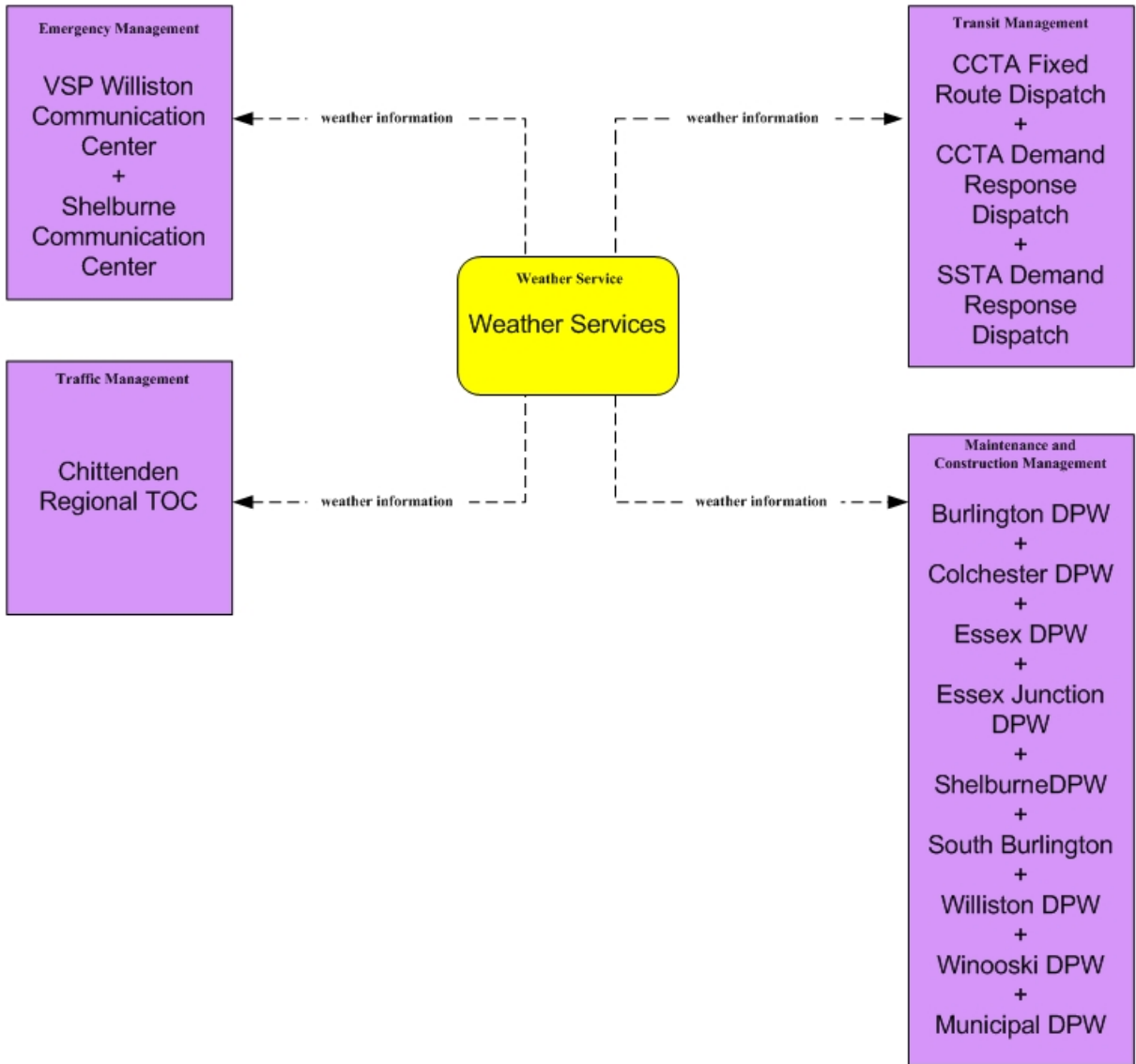

This instance represents the situation for this market package pending creation of the Chittenden Regional TOC. See the MC04 – Weather Services instance for market package details with existing entities only.

MC06 - Winter Maintenance  
Essex Junction DPW

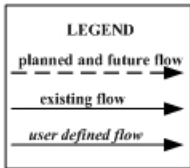
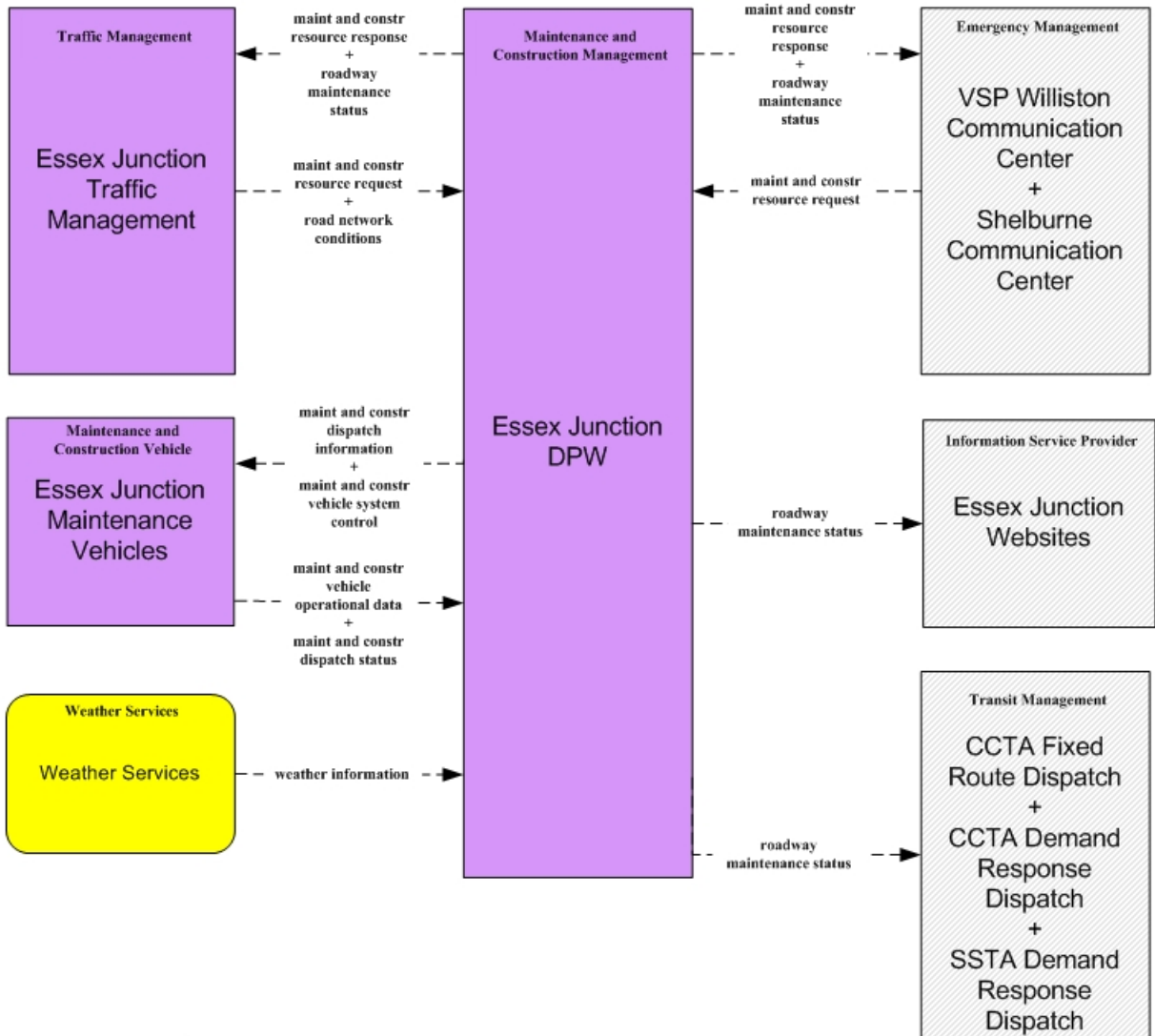

MC07 - Roadway Maintenance and Construction  
Essex Junction DPW

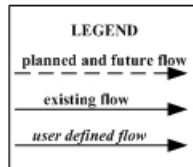
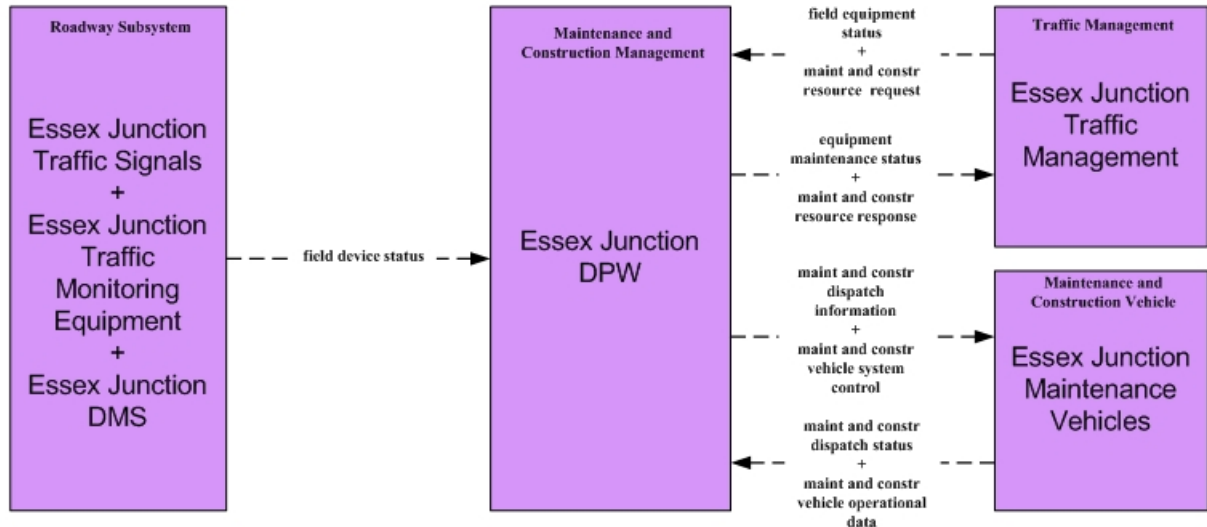

MC08 - Work Zone Management  
Essex Junction DPW

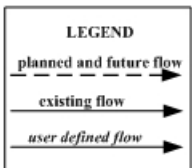
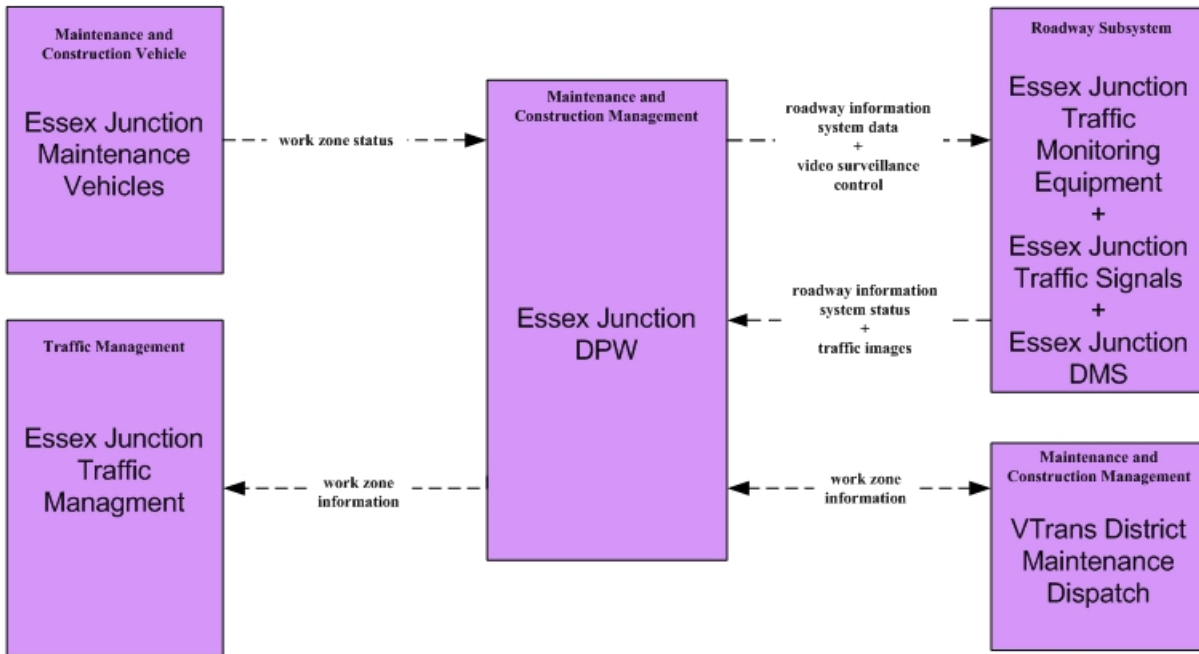

MC08 - Work Zone Management  
VTrans District Maintenance Dispatch

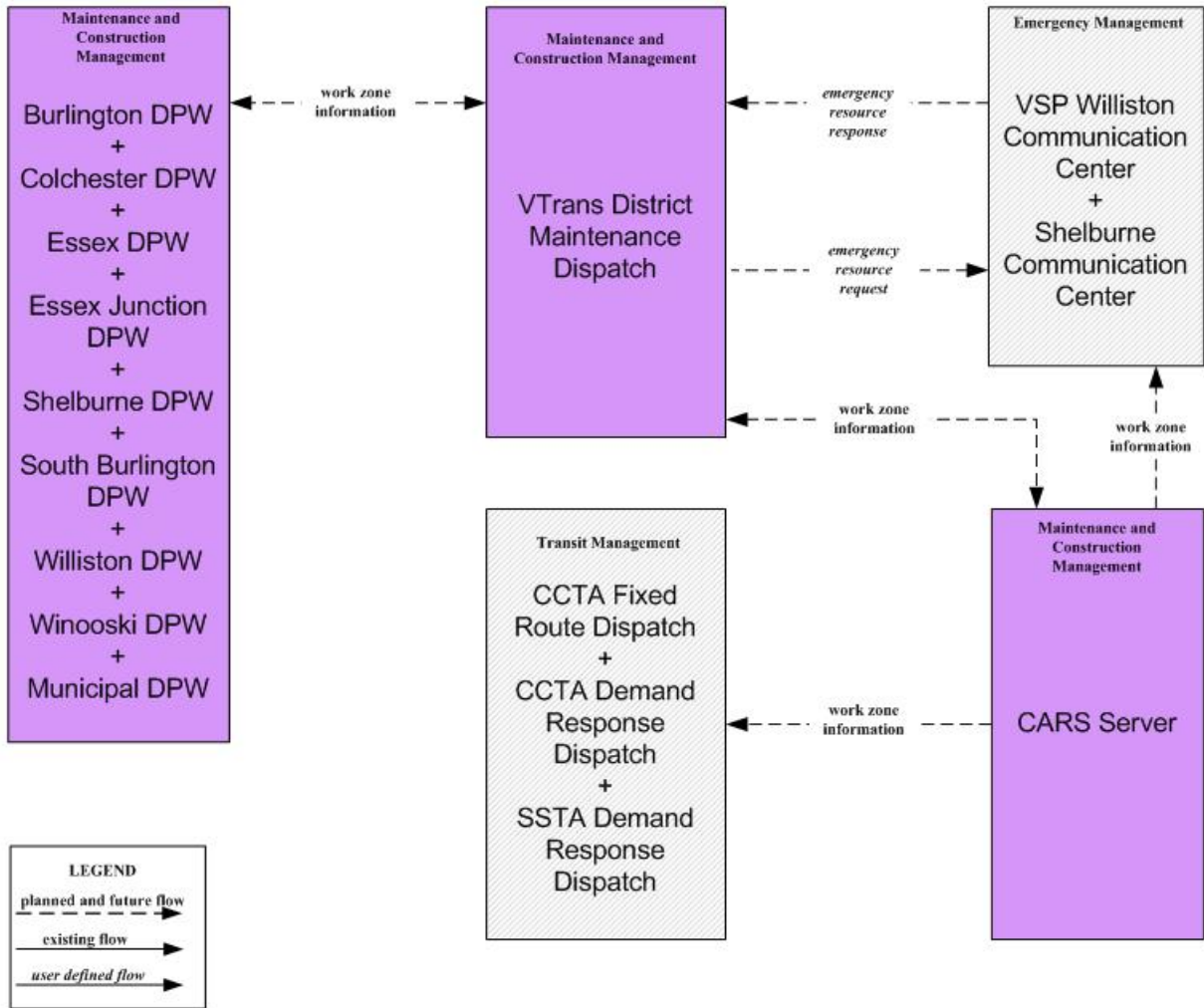

MC10 – Maintenance and Construction Activity Coordination  
Essex Junction DPW

