

AD2 - ITS Data Warehouse  
VTrans Data Warehouse

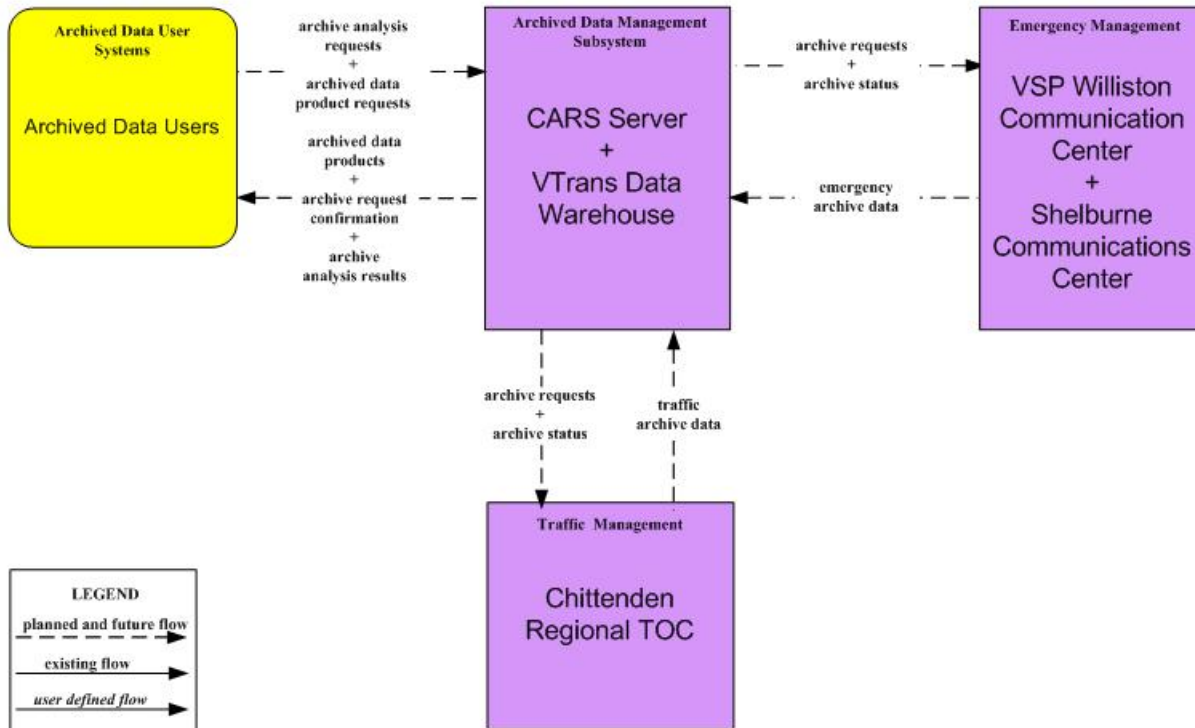

# APTS2 - Transit Fixed-Route Operations CCTA

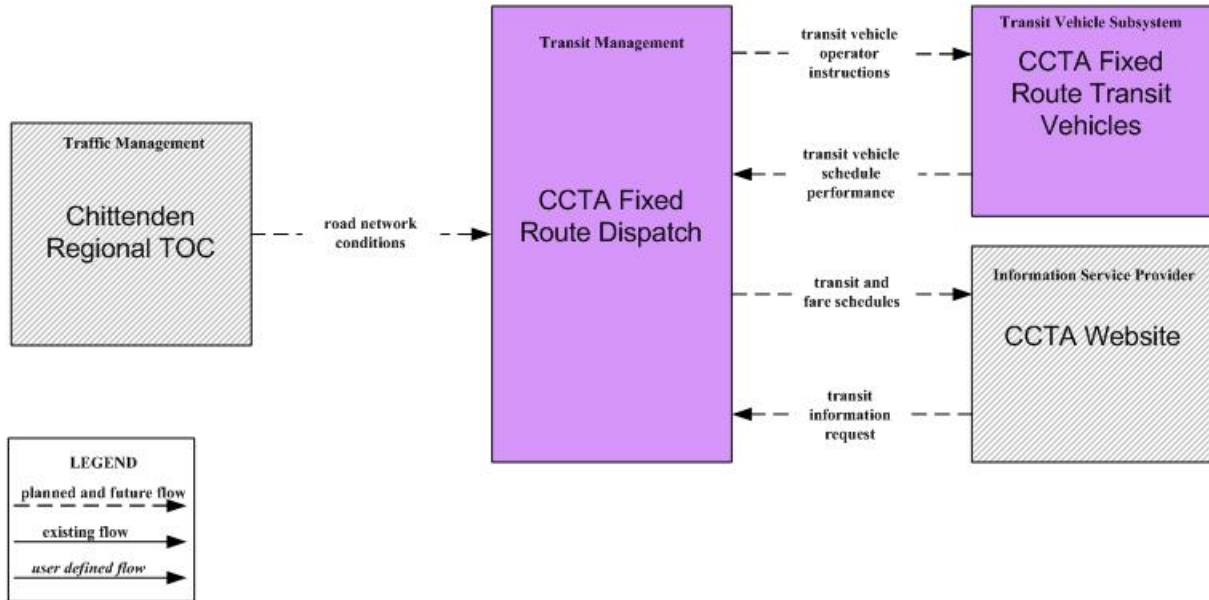

# APTS3 - Demand Response Transit Operations CCTA

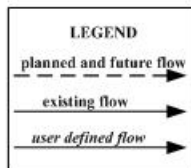
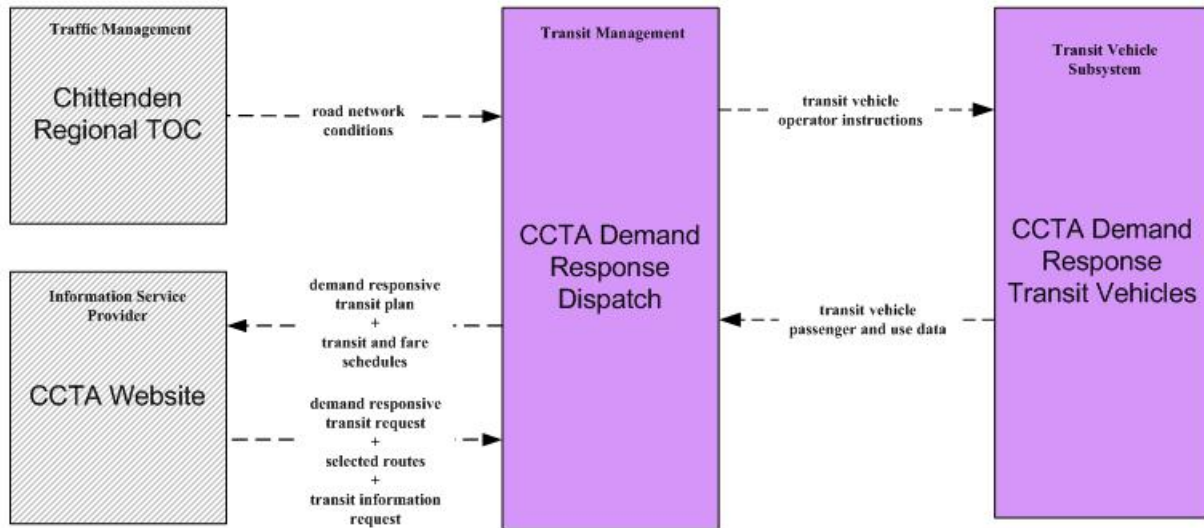

# APTS3 - Demand Response Transit Operations SSTA

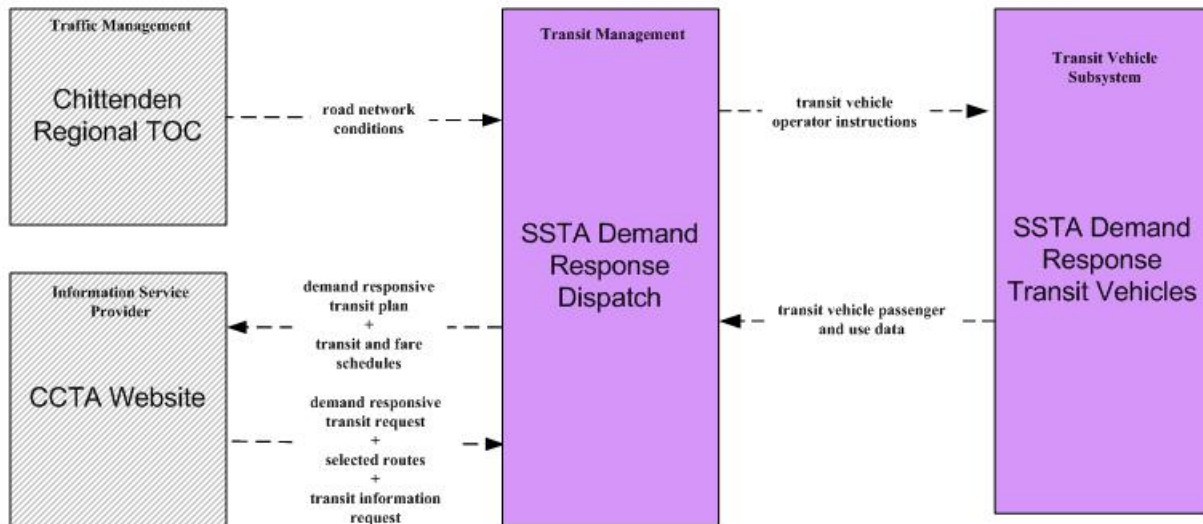

## LEGEND

*planned and future flow* →

*existing flow* →

*user defined flow* →

APTS7 – Multimodal Coordination  
 CCTA Fixed Route Dispatch – Chittenden Regional TOC and VTrans State TOC

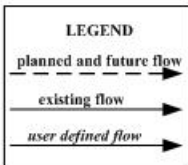
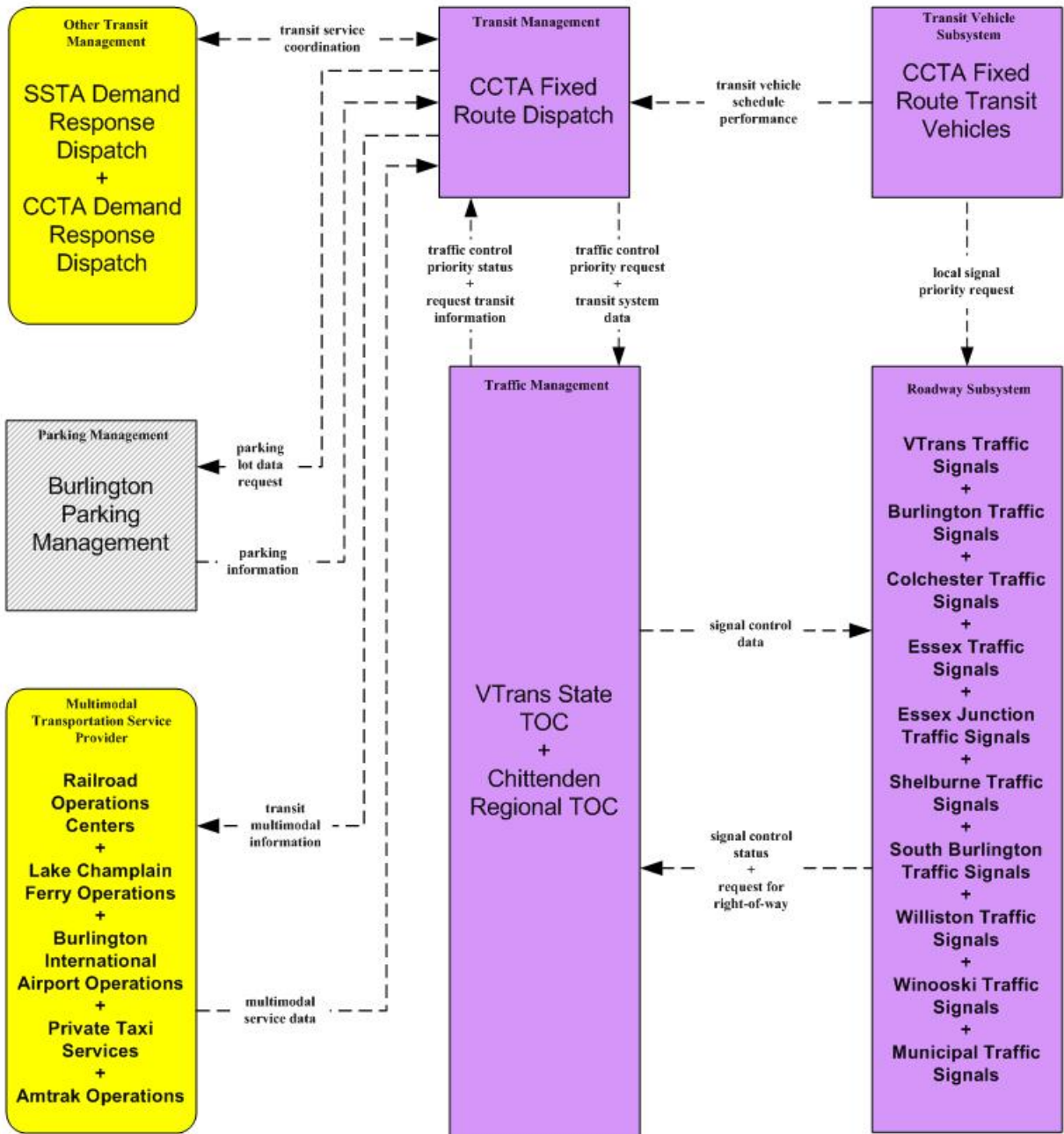

This market package instance is pending creation of the Chittenden Regional TOC. See the other APTS7 instance for details if it is not.

ATIS1 - Broadcast Traveler Information  
 CARS Information System – Chittenden Regional TOC

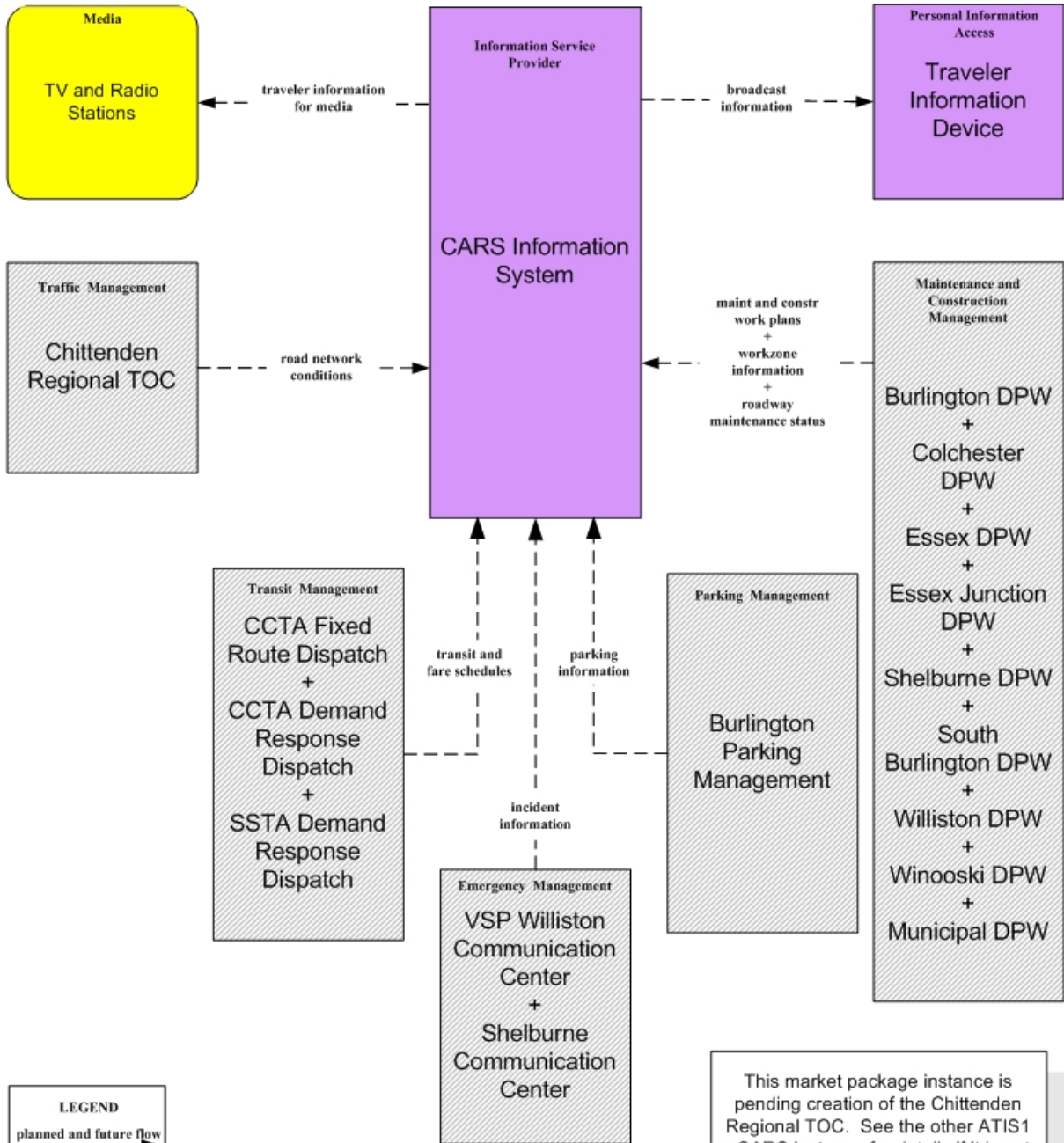

**LEGEND**

planned and future flow →

existing flow →

user defined flow →

This market package instance is pending creation of the Chittenden Regional TOC. See the other ATIS1 – CARS instance for details if it is not.

# ATIS2 – Interactive Traveler Information Vermont Travel Planner

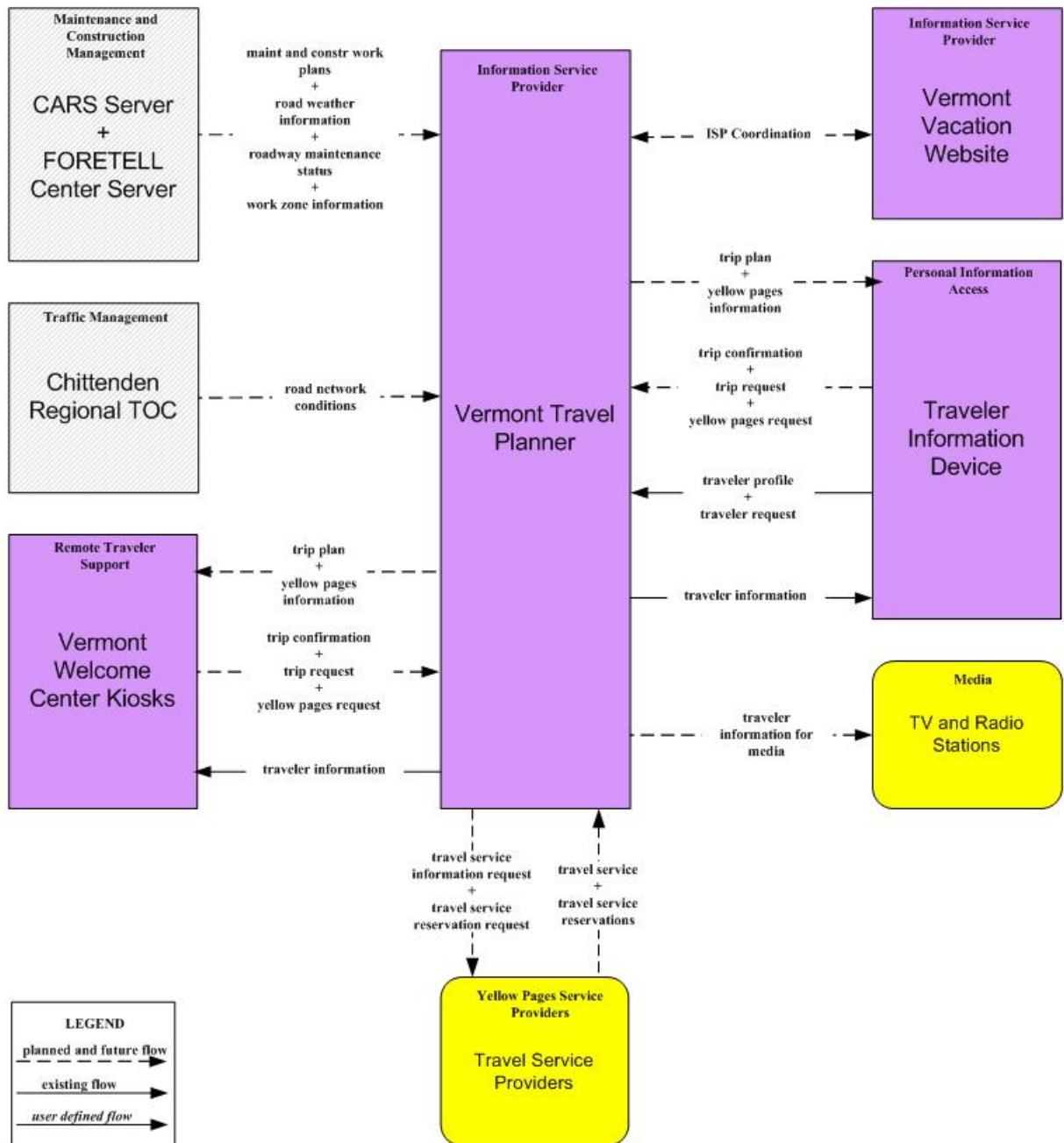



ATMS07 – Regional Traffic Control  
Chittenden Regional TOC

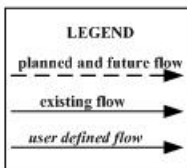
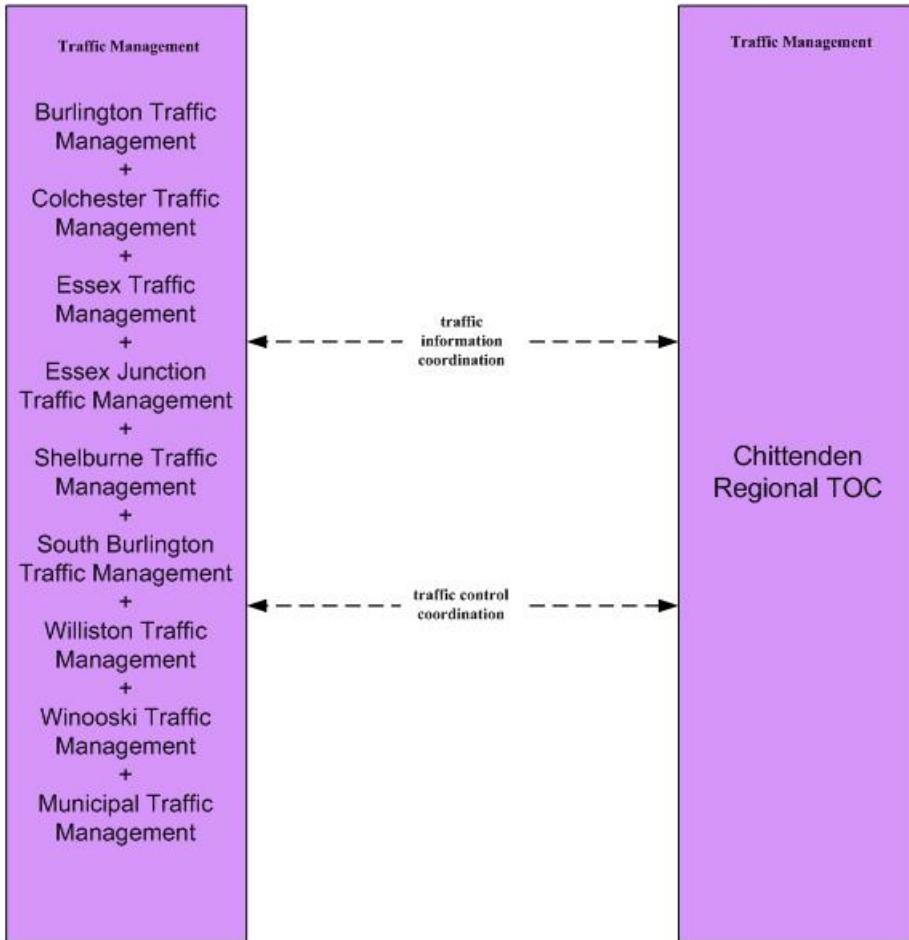



ATMS07 – Regional Traffic Control  
VTrans State TOC/Chittenden Regional TOC

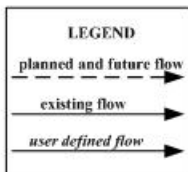
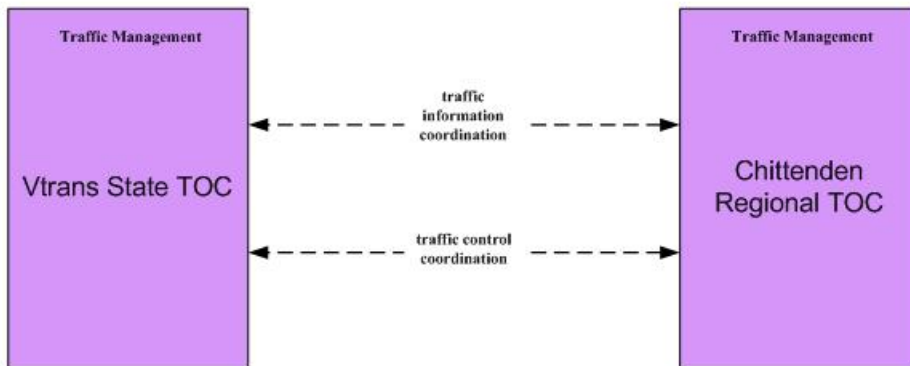

ATMS08 – Incident Management  
Chittenden Regional TOC

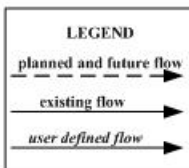
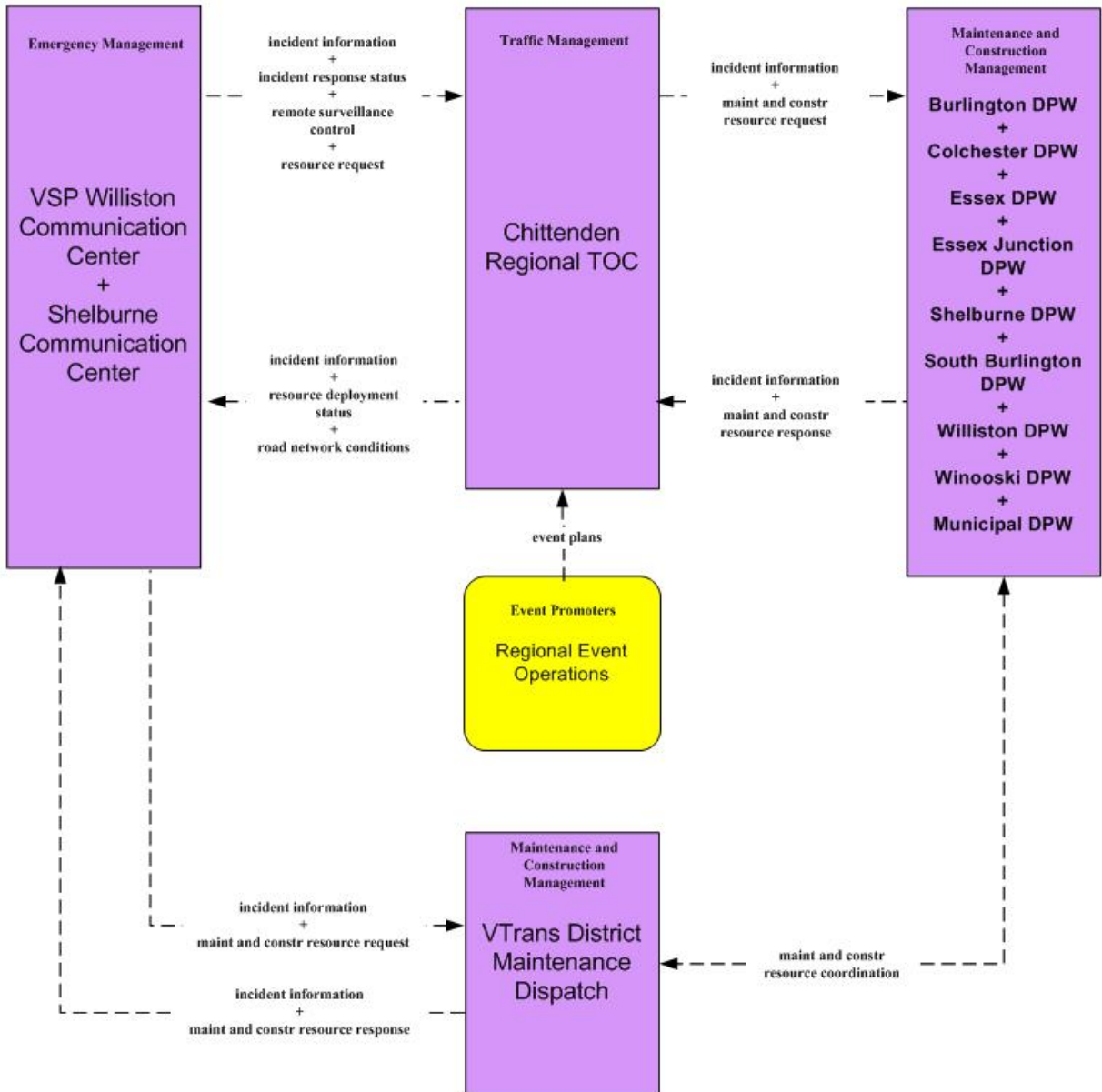

ATMS08 – Incident Management  
Rail Operations Centers

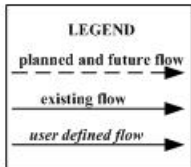
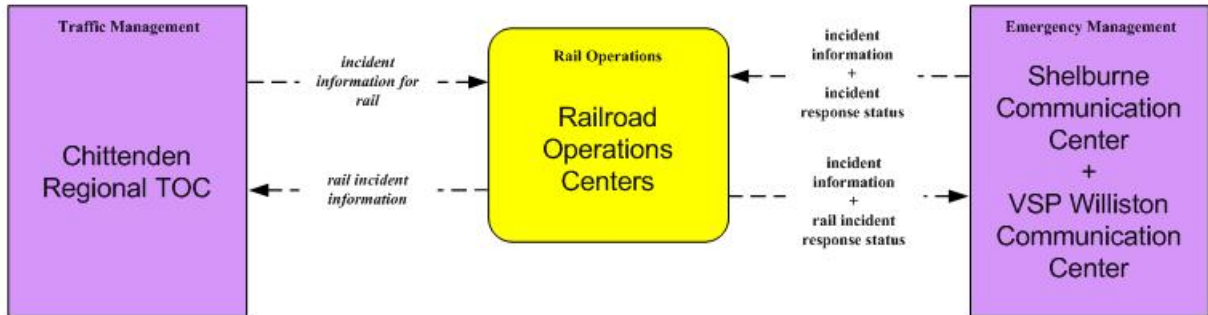

**ATMS13 - Standard Railroad Grade Crossing  
Chittenden Regional Traffic Operations Center (Future)**

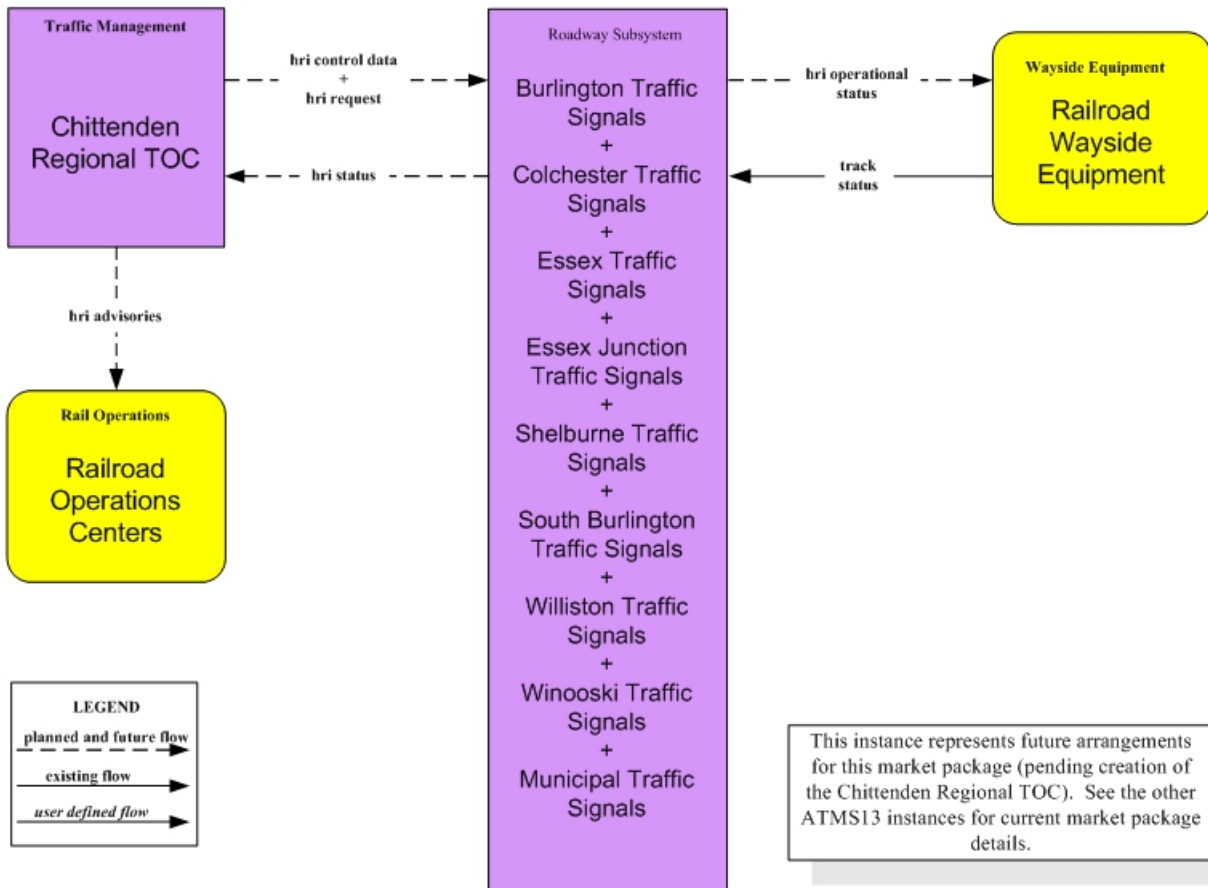

ATMS15 – Railroad Operations Coordination  
Chittenden Regional TOC

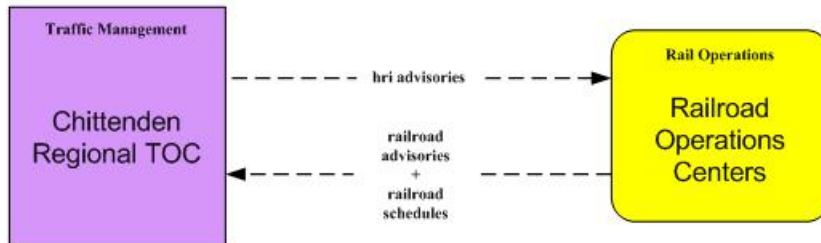

This market package instance is pending creation of the Chittenden Regional TOC. See the other ATMS15 instance for market package details without it.

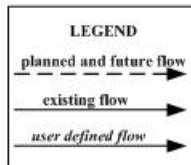

ATMS16 - Parking Facility Management  
Burlington Parking Management

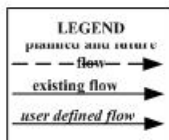
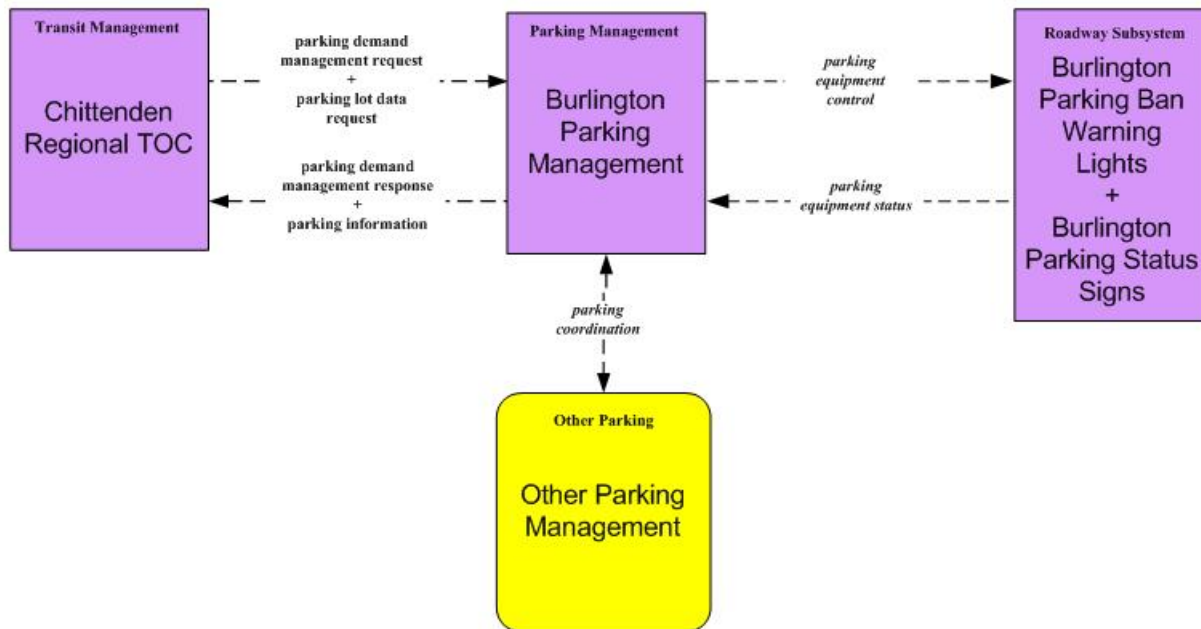

ATMS18 – Reversible Lane Management  
Chittenden Regional TOC (Future)

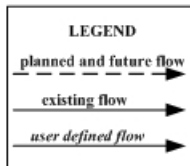
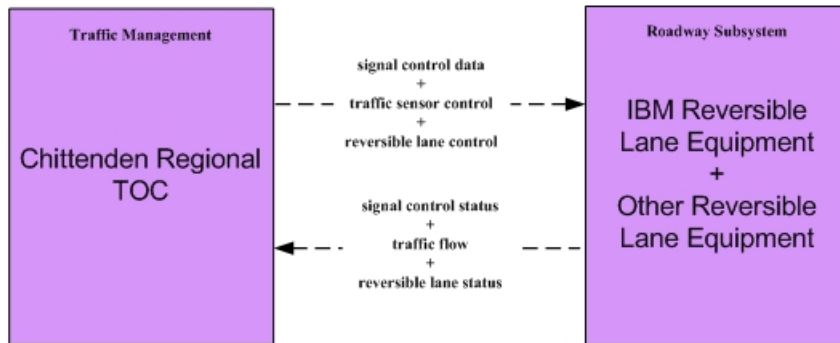



EMO2 – Emergency Routing  
1 of 2 - Chittenden Regional TOC

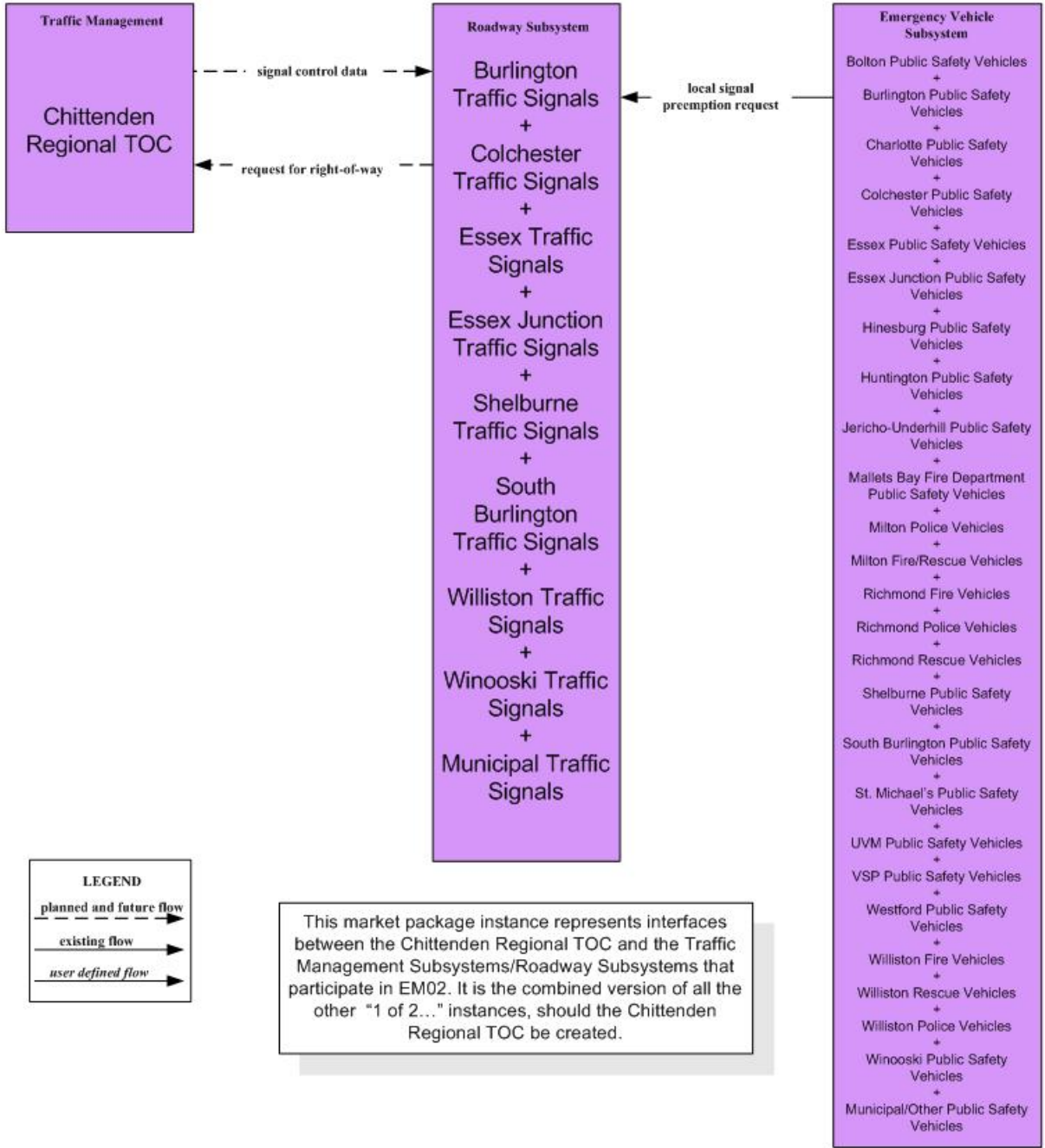

# EMO2 – Emergency Routing

## 2 of 2 - Emergency Management – Chittenden Regional TOC

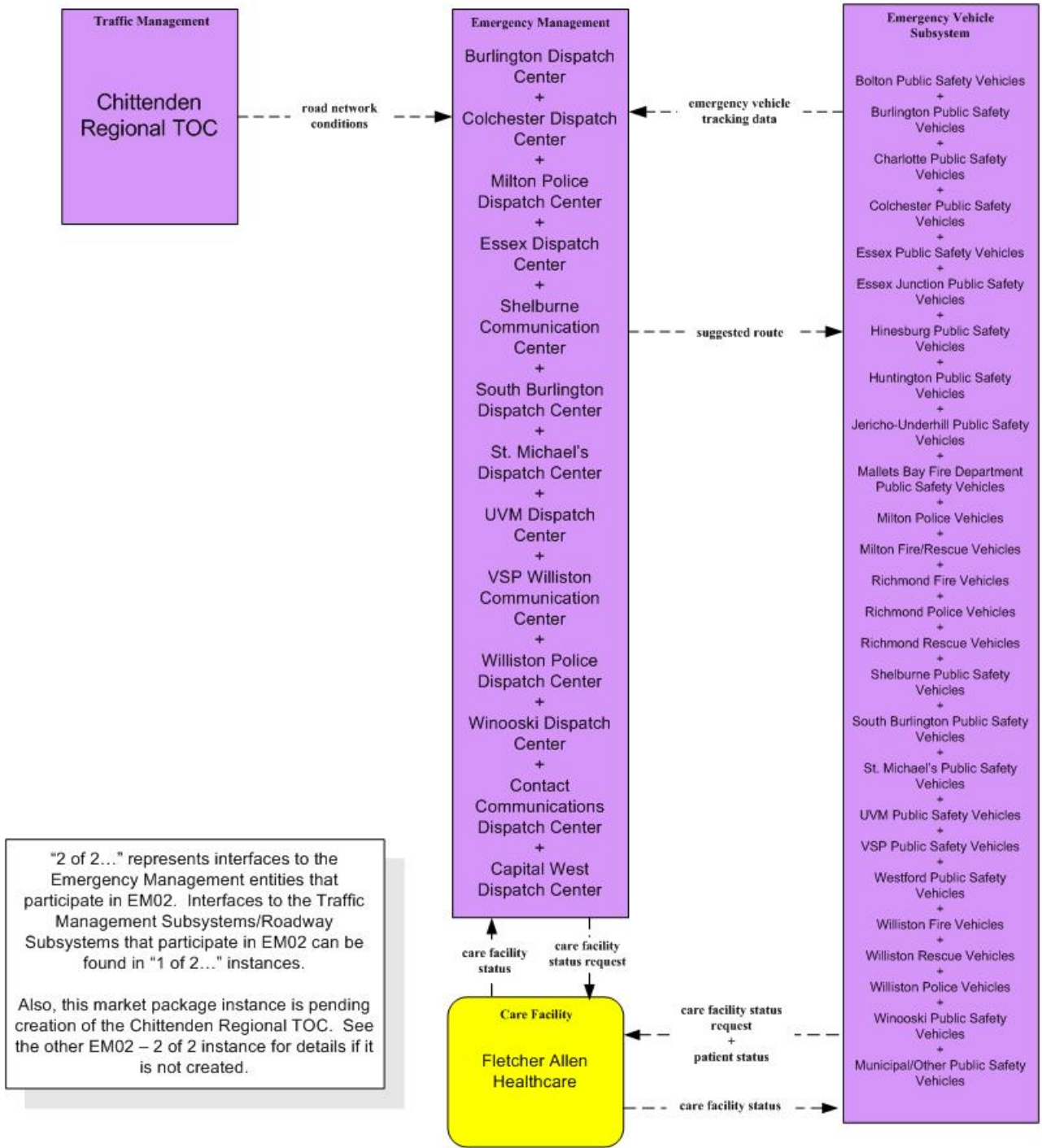

"2 of 2..." represents interfaces to the Emergency Management entities that participate in EM02. Interfaces to the Traffic Management Subsystems/Roadway Subsystems that participate in EM02 can be found in "1 of 2..." instances.

Also, this market package instance is pending creation of the Chittenden Regional TOC. See the other EM02 – 2 of 2 instance for details if it is not created.

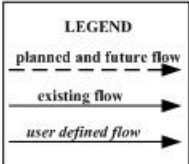

EMO6 – Wide Area Alert  
 Vermont Statewide EOC & VSP Headquarters – Chittenden Regional TOC

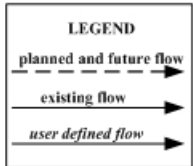
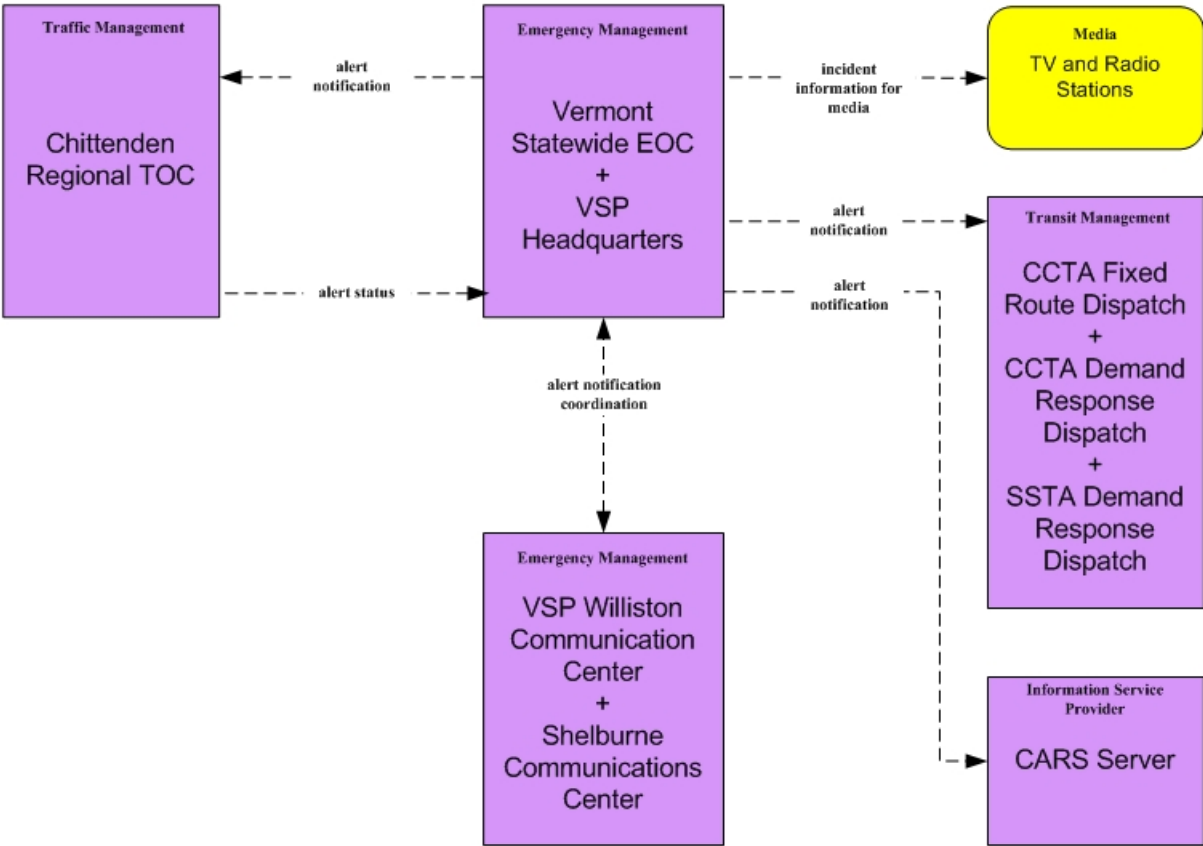

EM09 - Evacuation and Reentry Management  
Vermont Statewide EOC

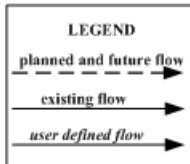
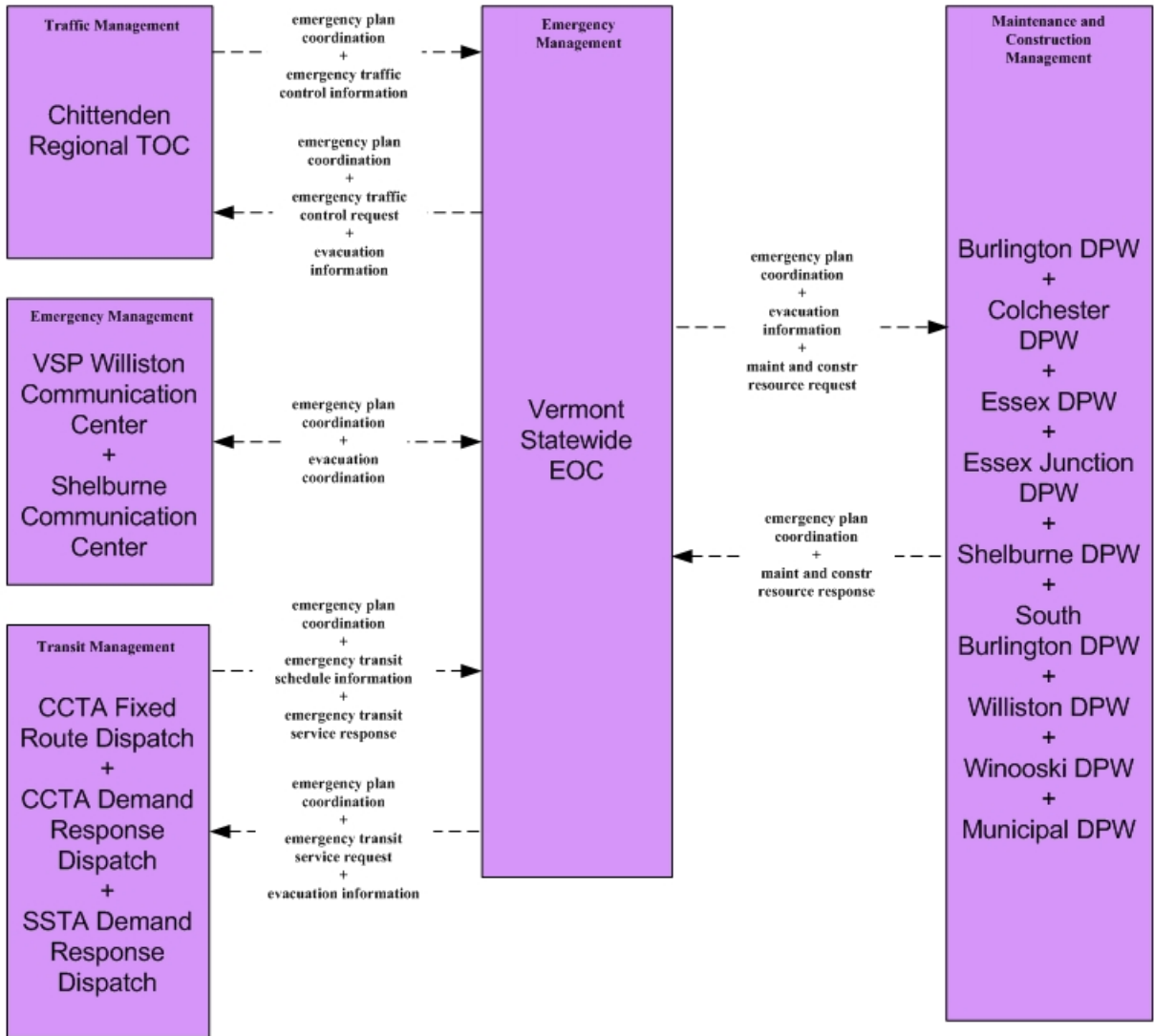

MC04 - Weather Information Processing and Distribution  
CARS

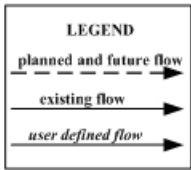
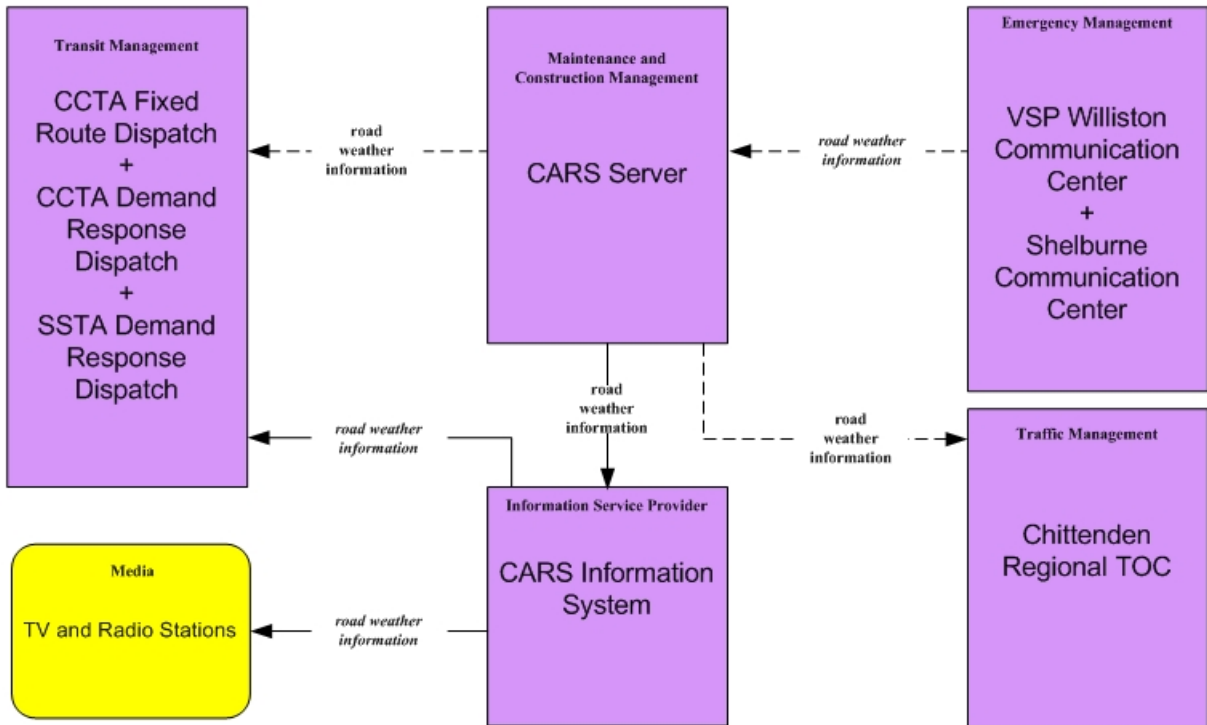

MC04 – Weather Information Processing and Distribution  
Chittenden Regional TOC

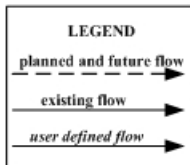
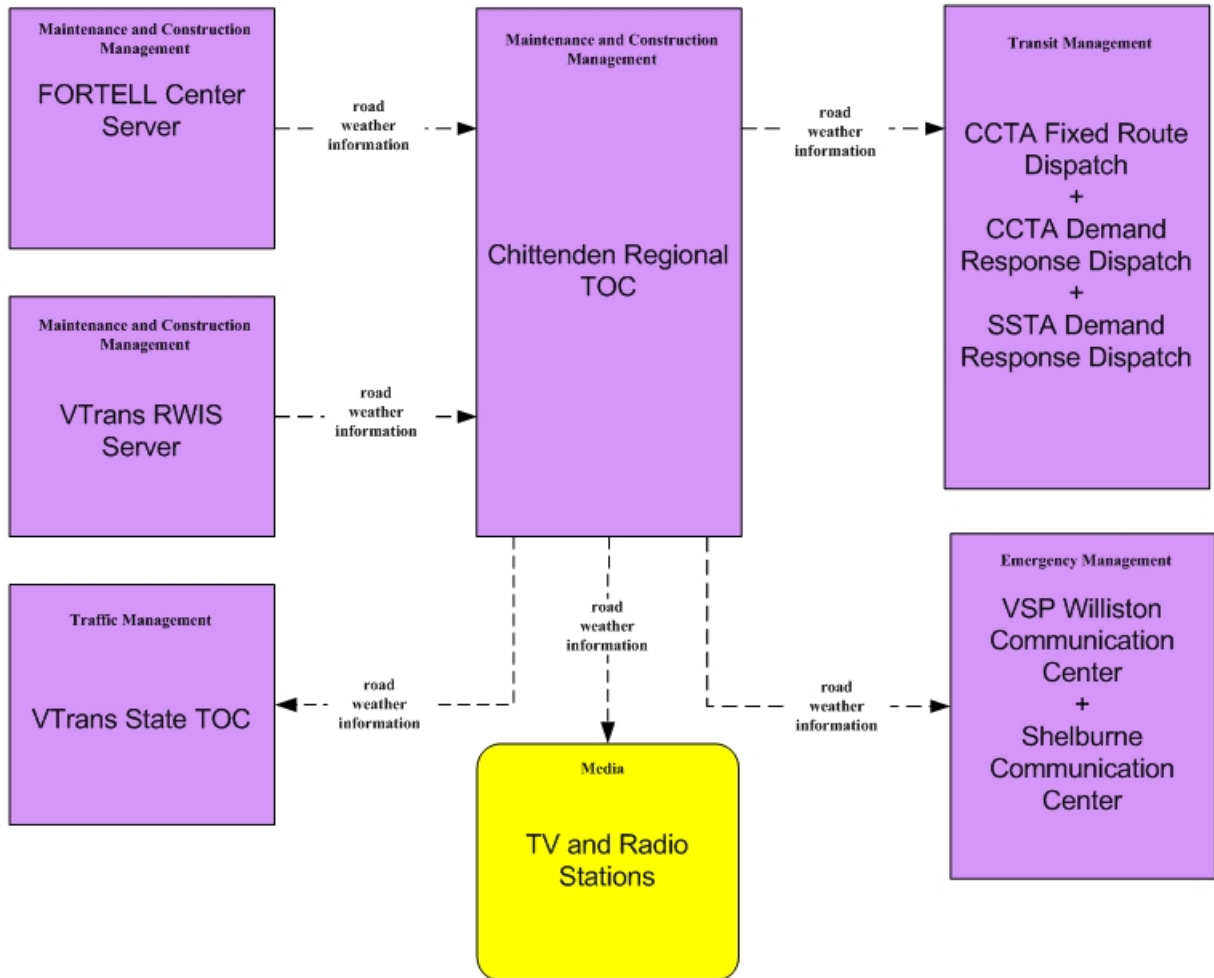

MC04 - Weather Information Processing and Distribution  
Weather Services – Chittenden Regional TOC

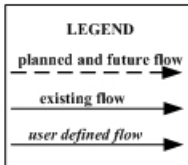
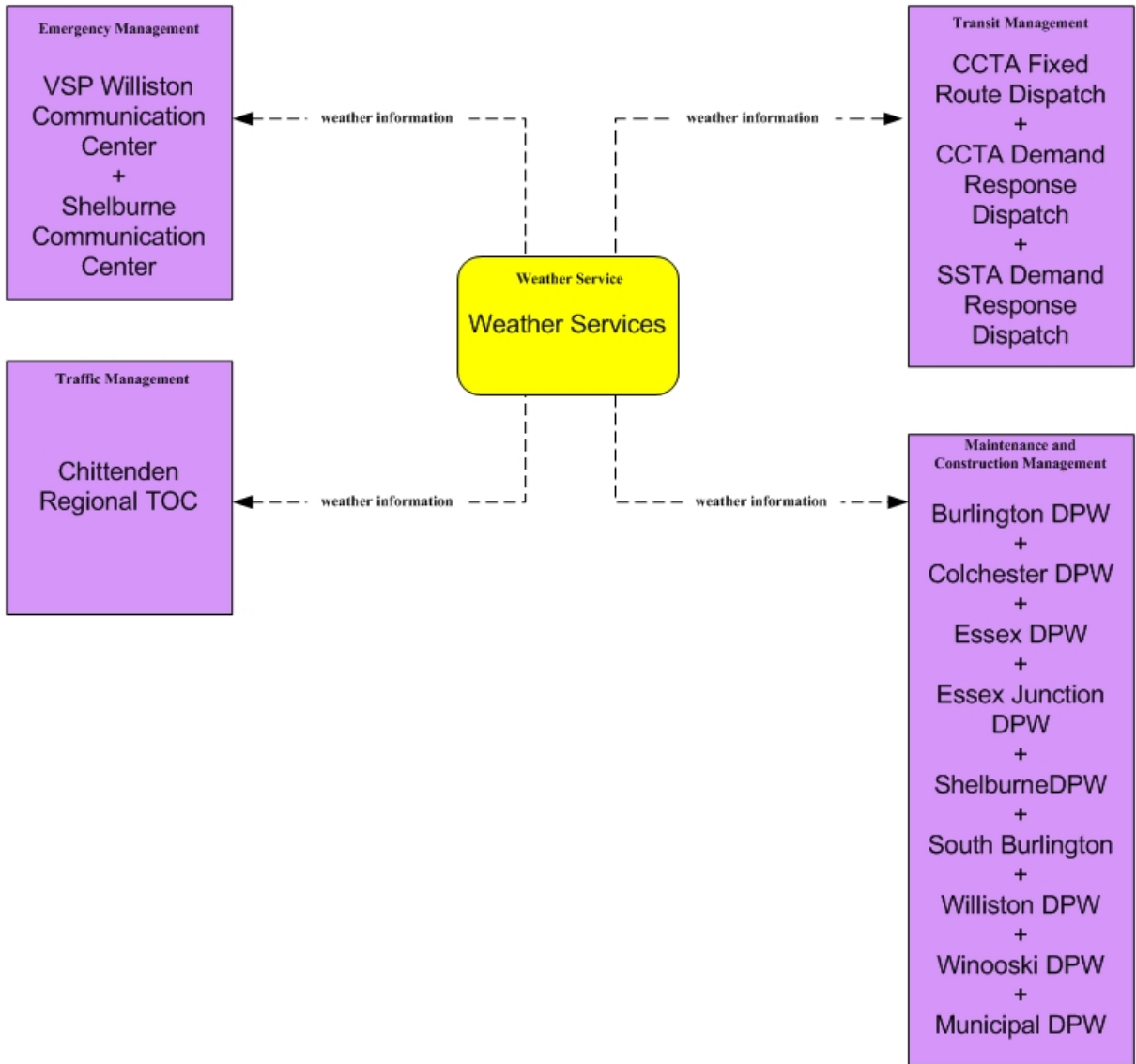

This instance represents the situation for this market package pending creation of the Chittenden Regional TOC. See the MC04 – Weather Services instance for market package details with existing entities only.



MC06 - Winter Maintenance  
VTrans District Maintenance Dispatch

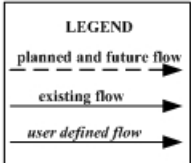
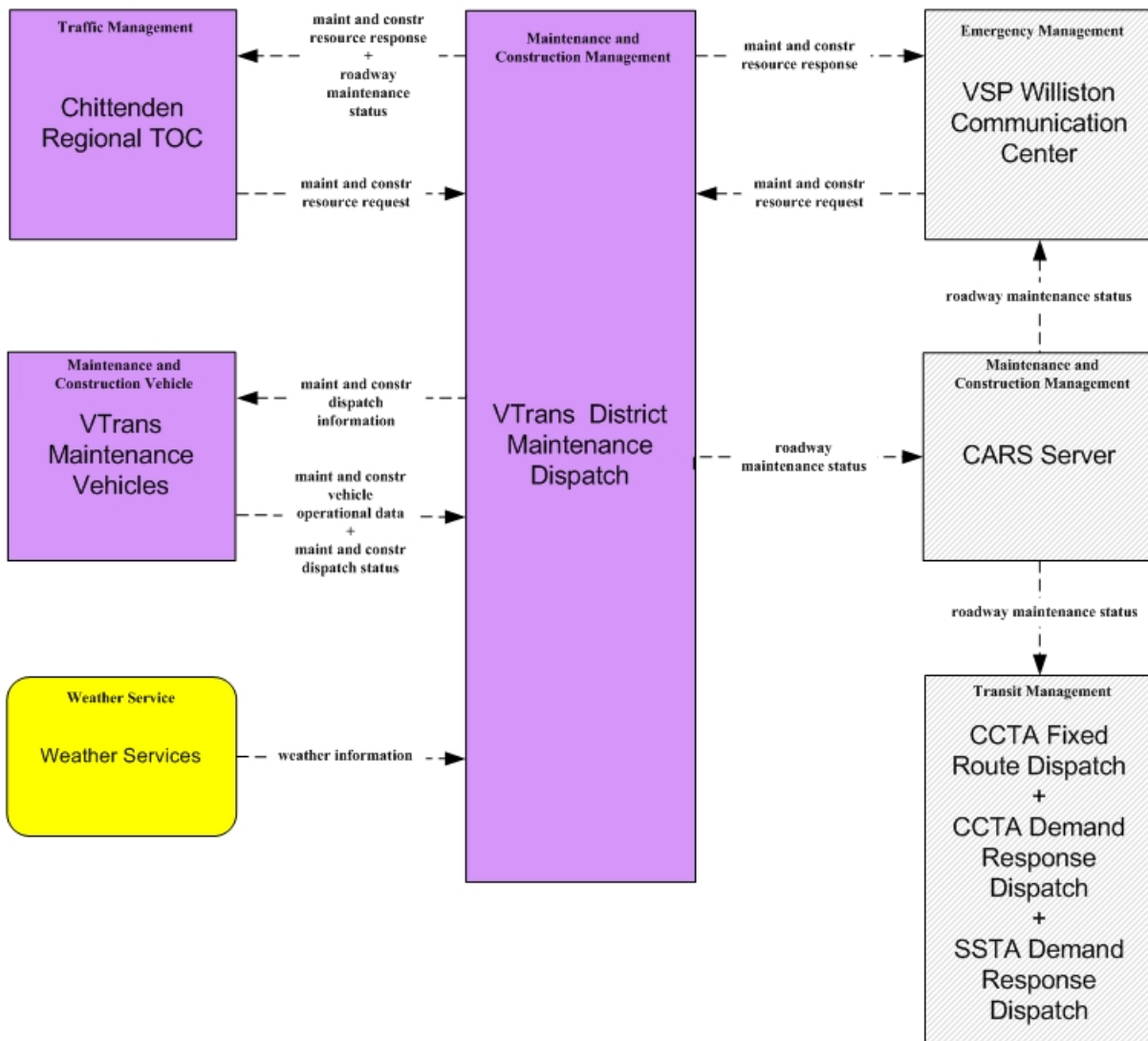

MC10 – Maintenance and Construction Activity Coordination  
Burlington DPW

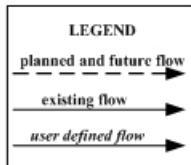
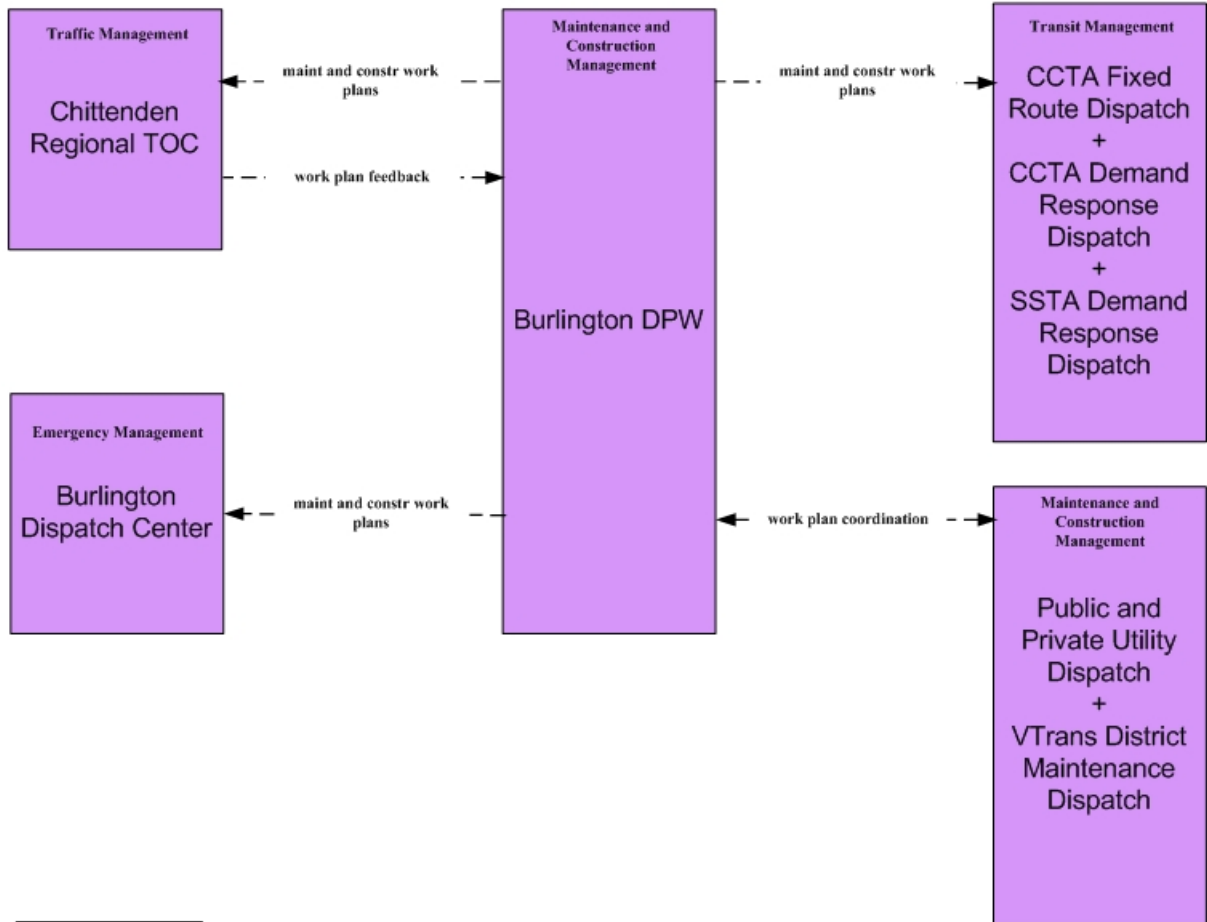

MC10 – Maintenance and Construction Activity Coordination  
Colchester DPW

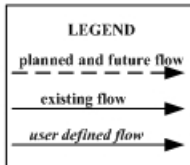
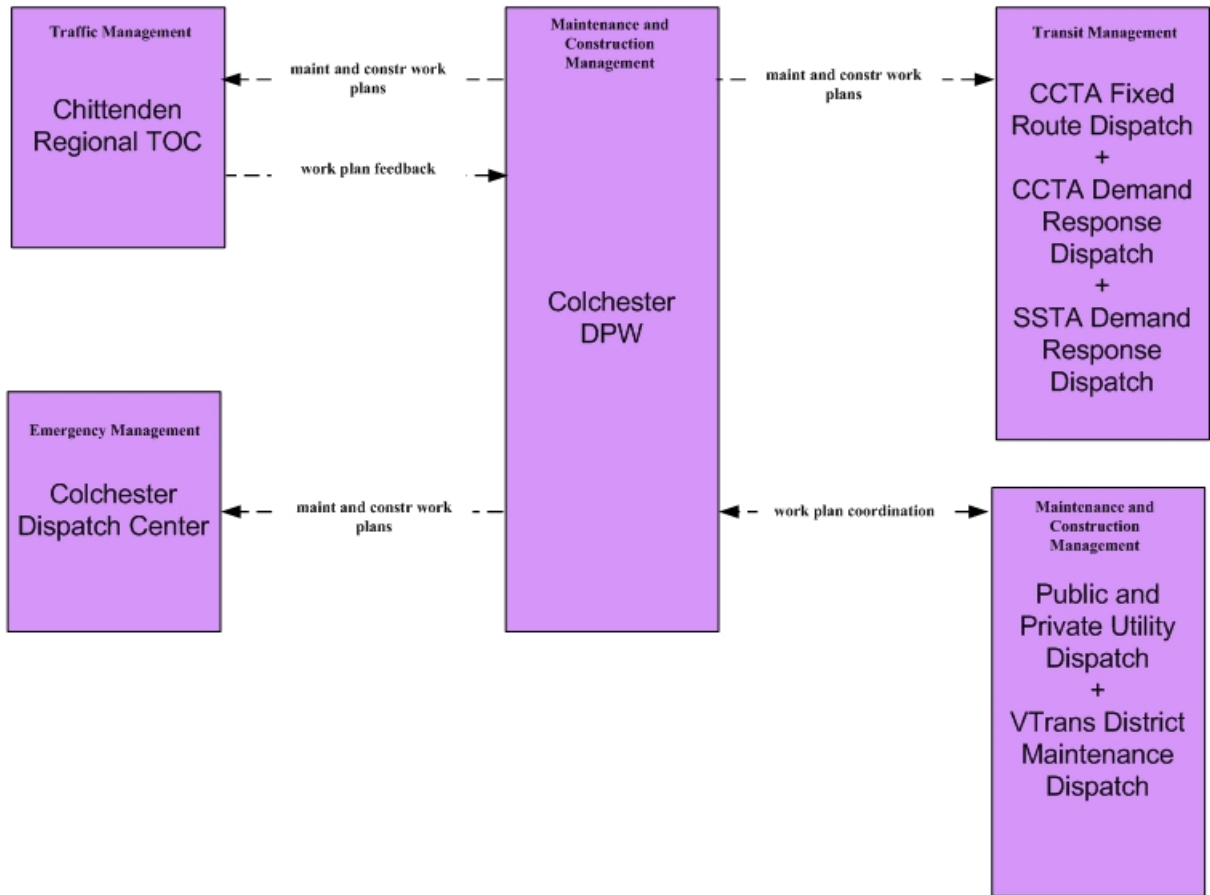

MC10 – Maintenance and Construction Activity Coordination  
Essex DPW

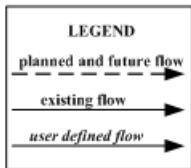
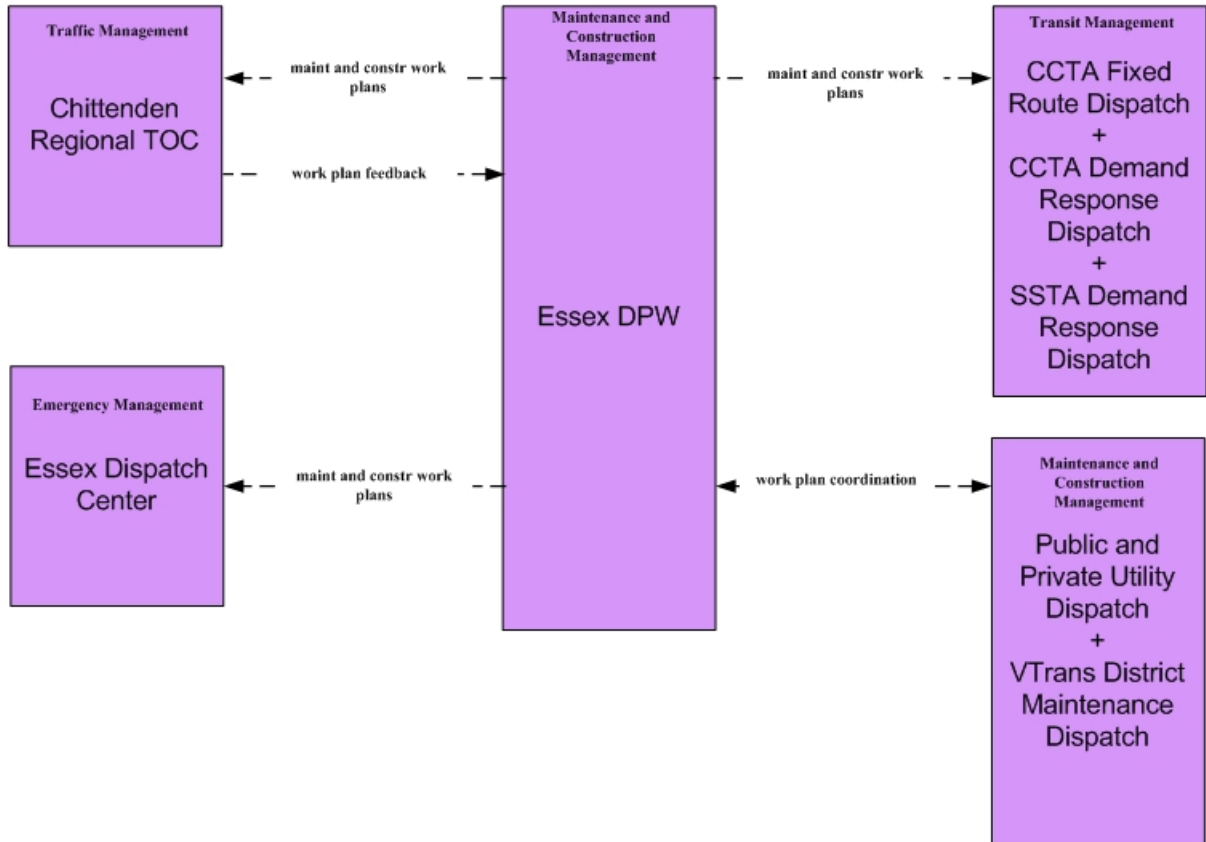

MC10 – Maintenance and Construction Activity Coordination  
Essex Junction DPW

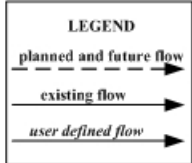
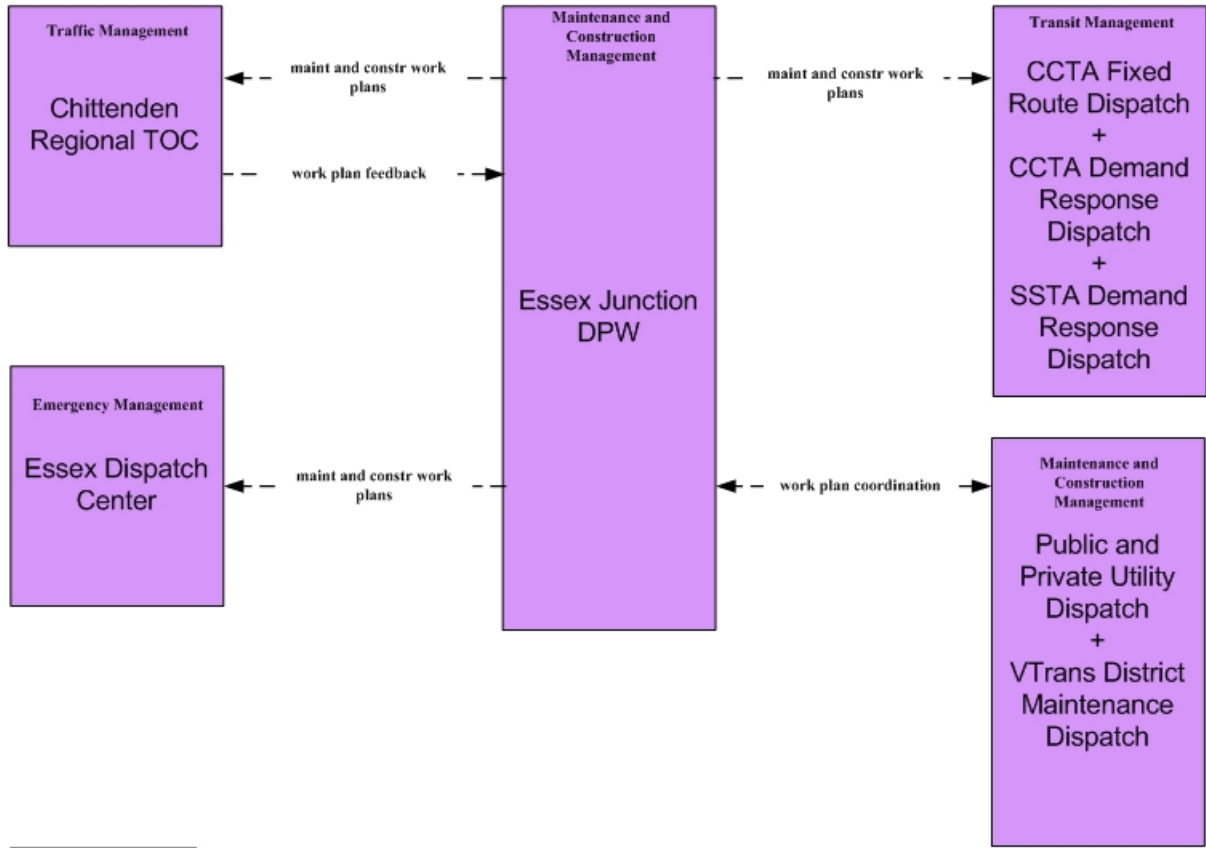

MC10 – Maintenance and Construction Activity Coordination  
Municipal DPW

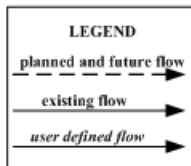
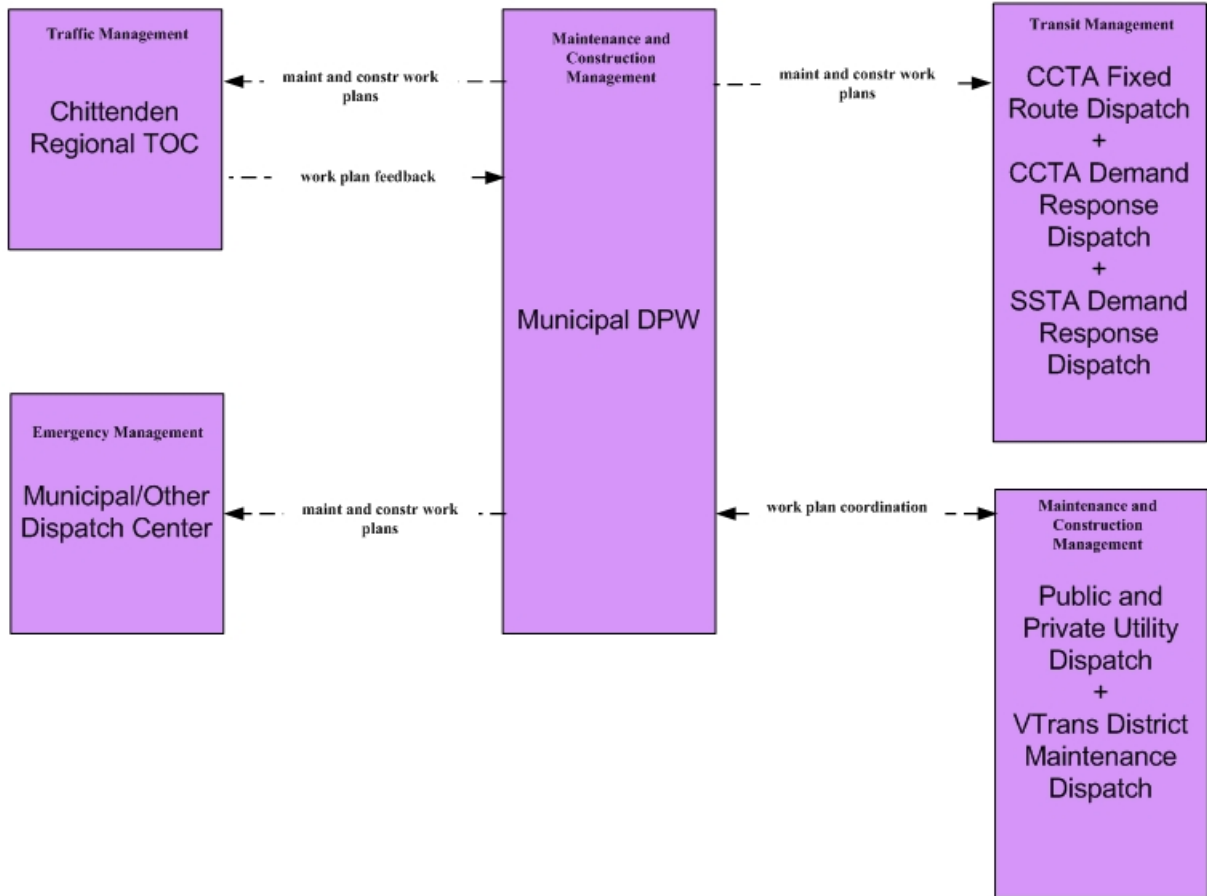

MC10 – Maintenance and Construction Activity Coordination  
Shelburne DPW

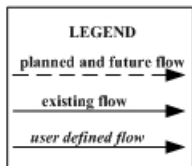
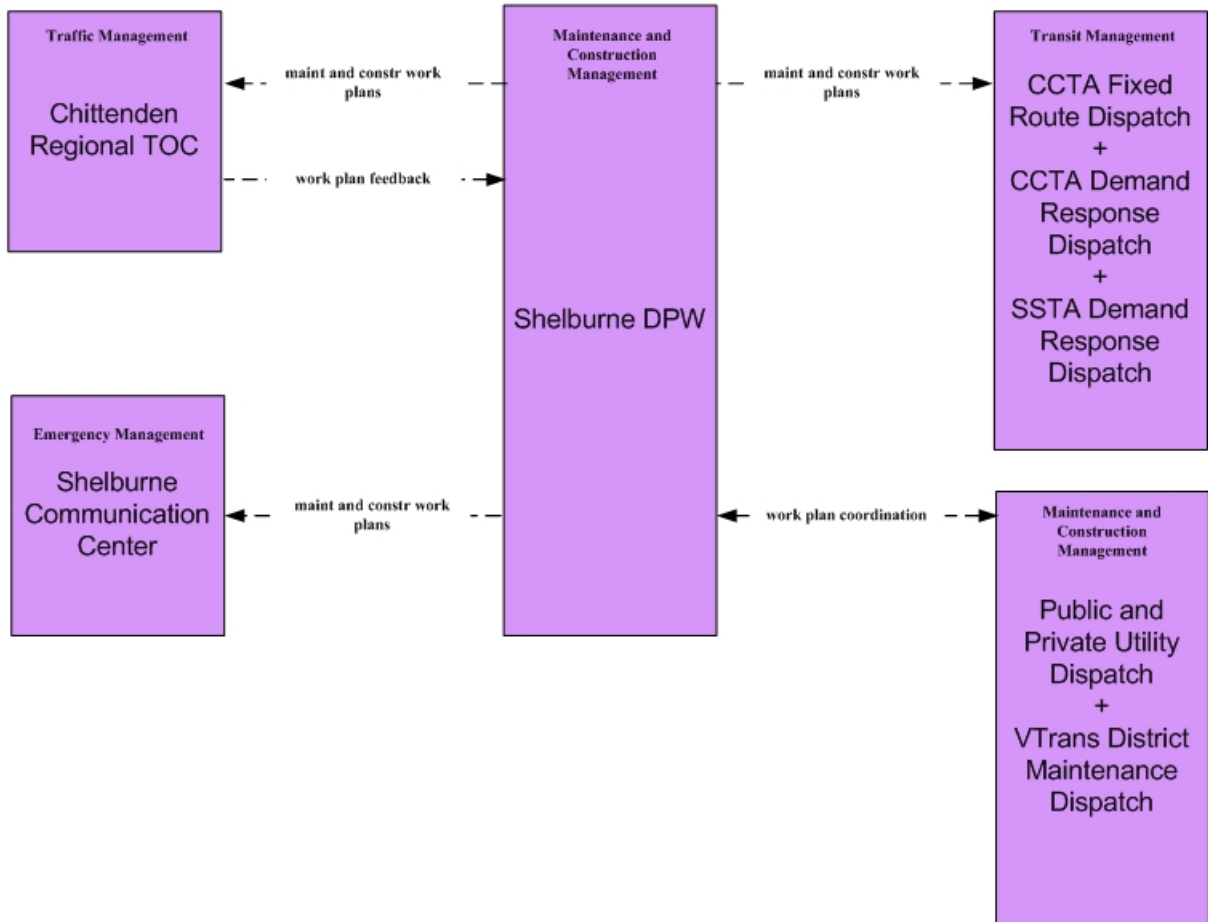



MC10 – Maintenance and Construction Activity Coordination  
South Burlington DPW

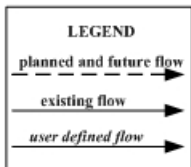
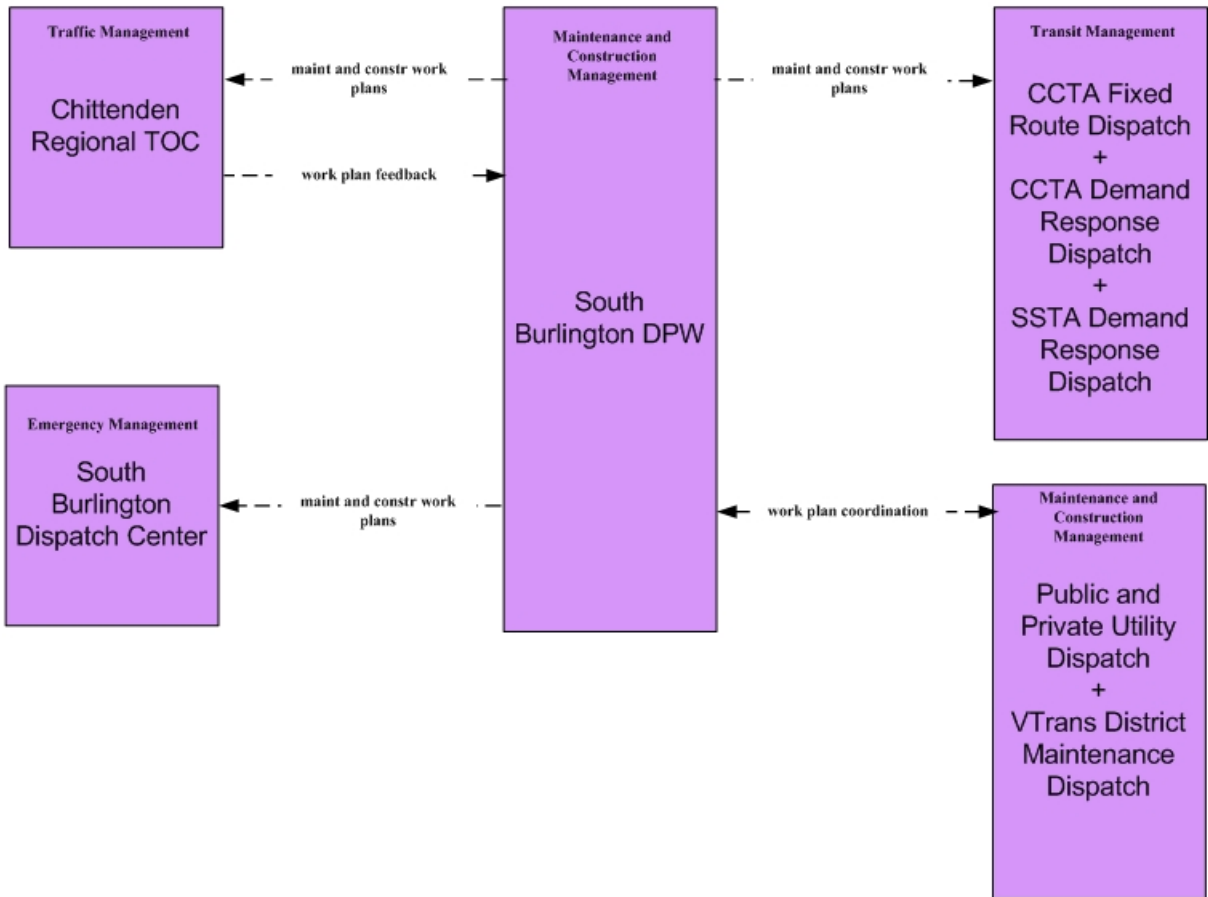

MC10 – Maintenance and Construction Activity Coordination  
VTrans

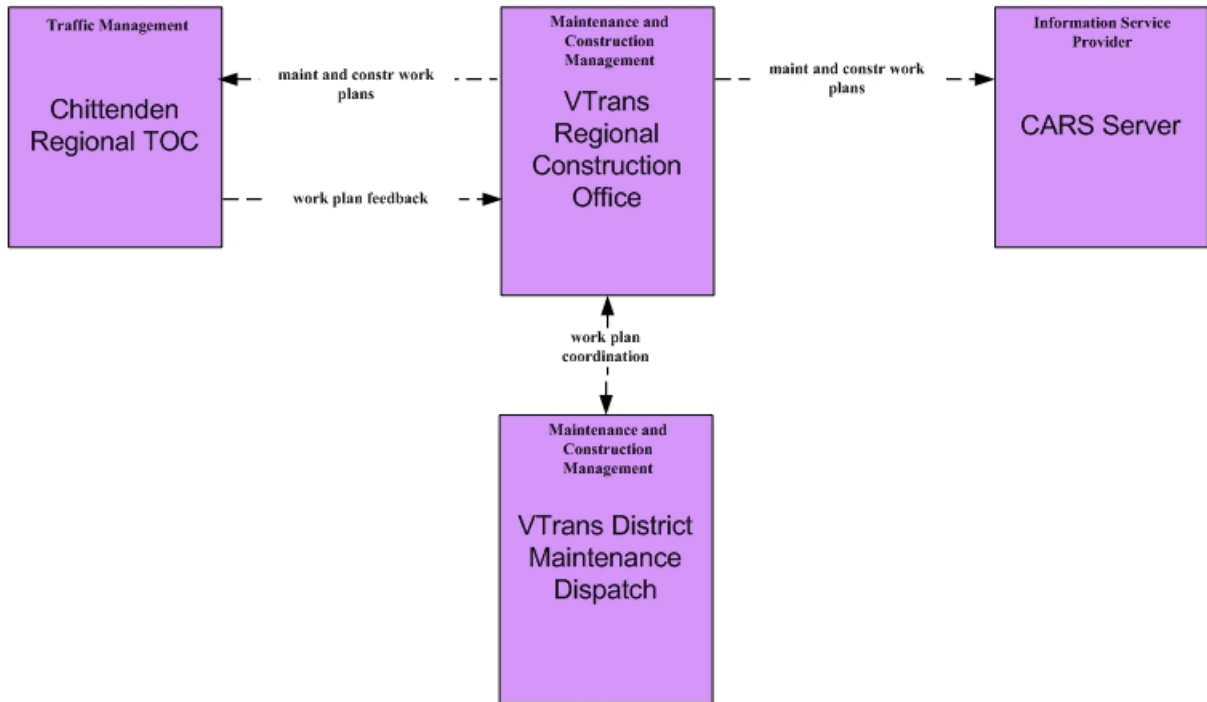

LEGEND

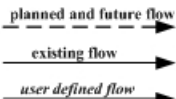

MC10 – Maintenance and Construction Activity Coordination  
Williston DPW

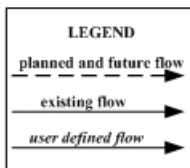
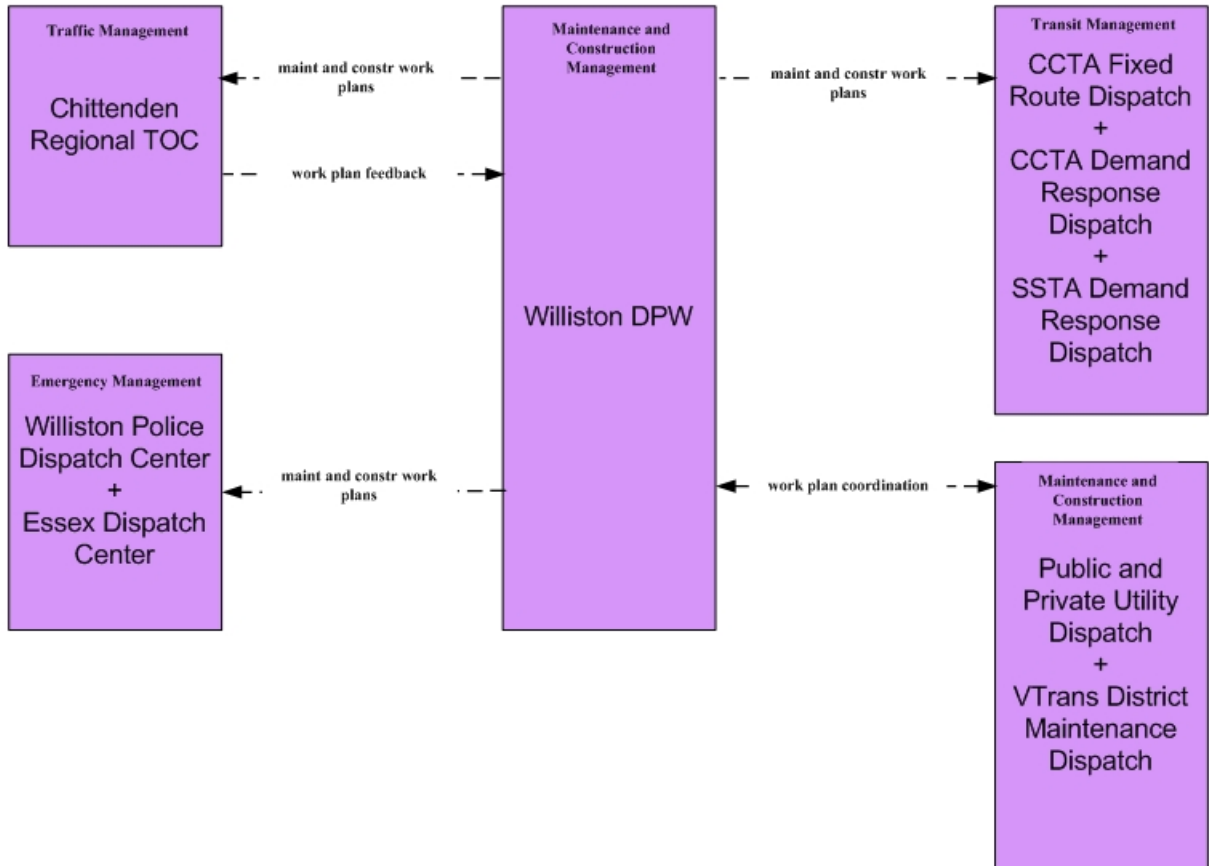

MC10 – Maintenance and Construction Activity Coordination  
Winooski DPW

