

ATIS1 - Broadcast Traveler Information Burlington Website

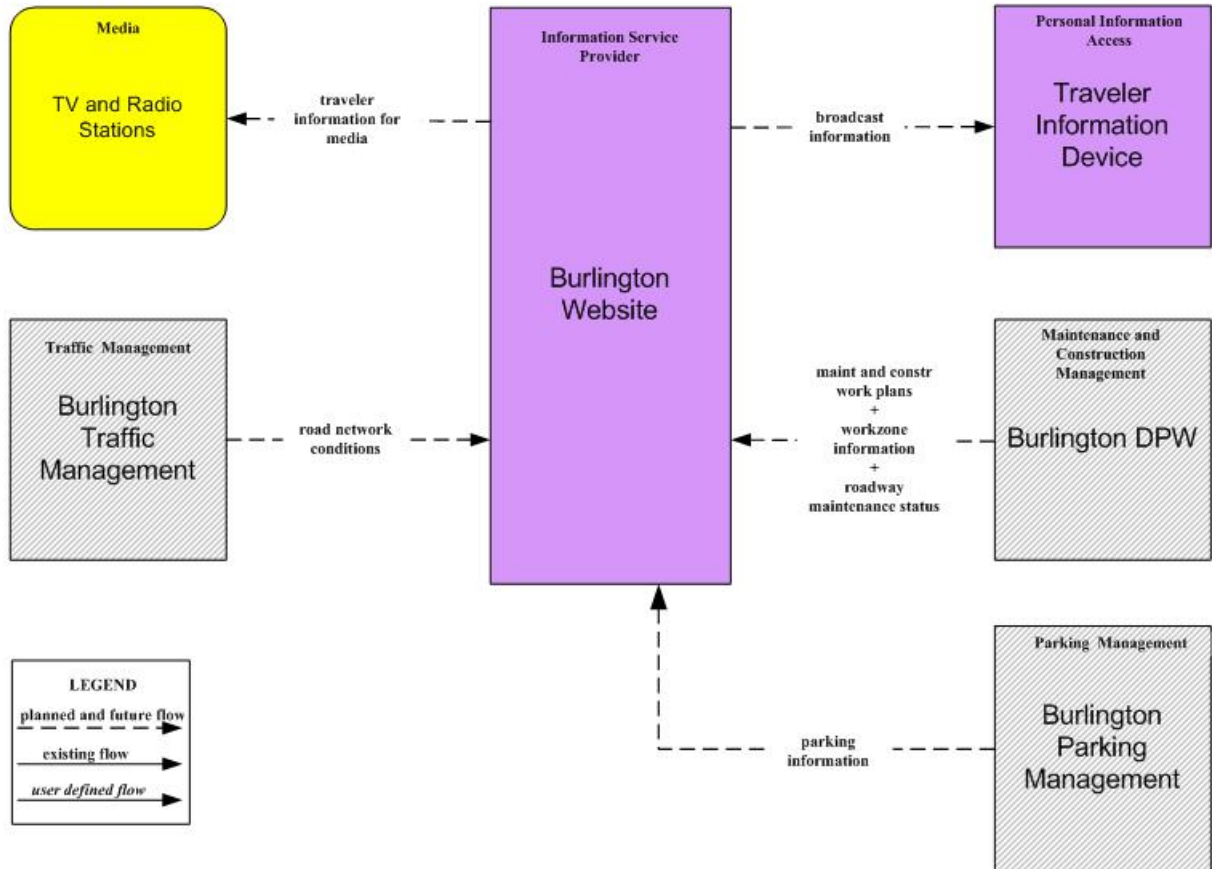

ATIS1 - Broadcast Traveler Information CARS Information System

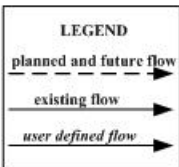
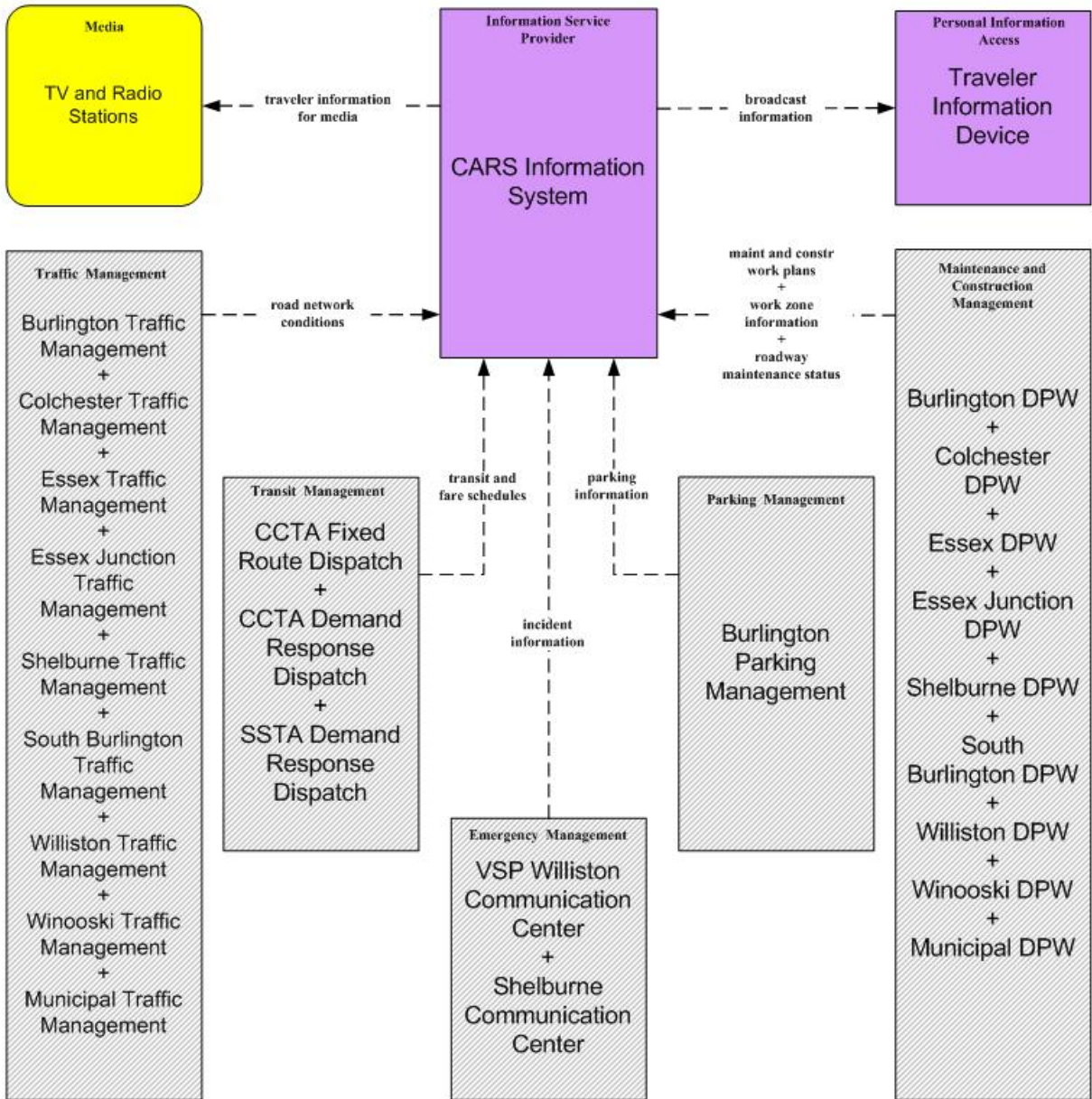

This market package instance is valid if the Chittenden Regional TOC is not created. See the ATIS1 – CARS – Chittenden Regional TOC instance for details if it is.

ATIS1 - Broadcast Traveler Information
 CARS Information System – Chittenden Regional TOC

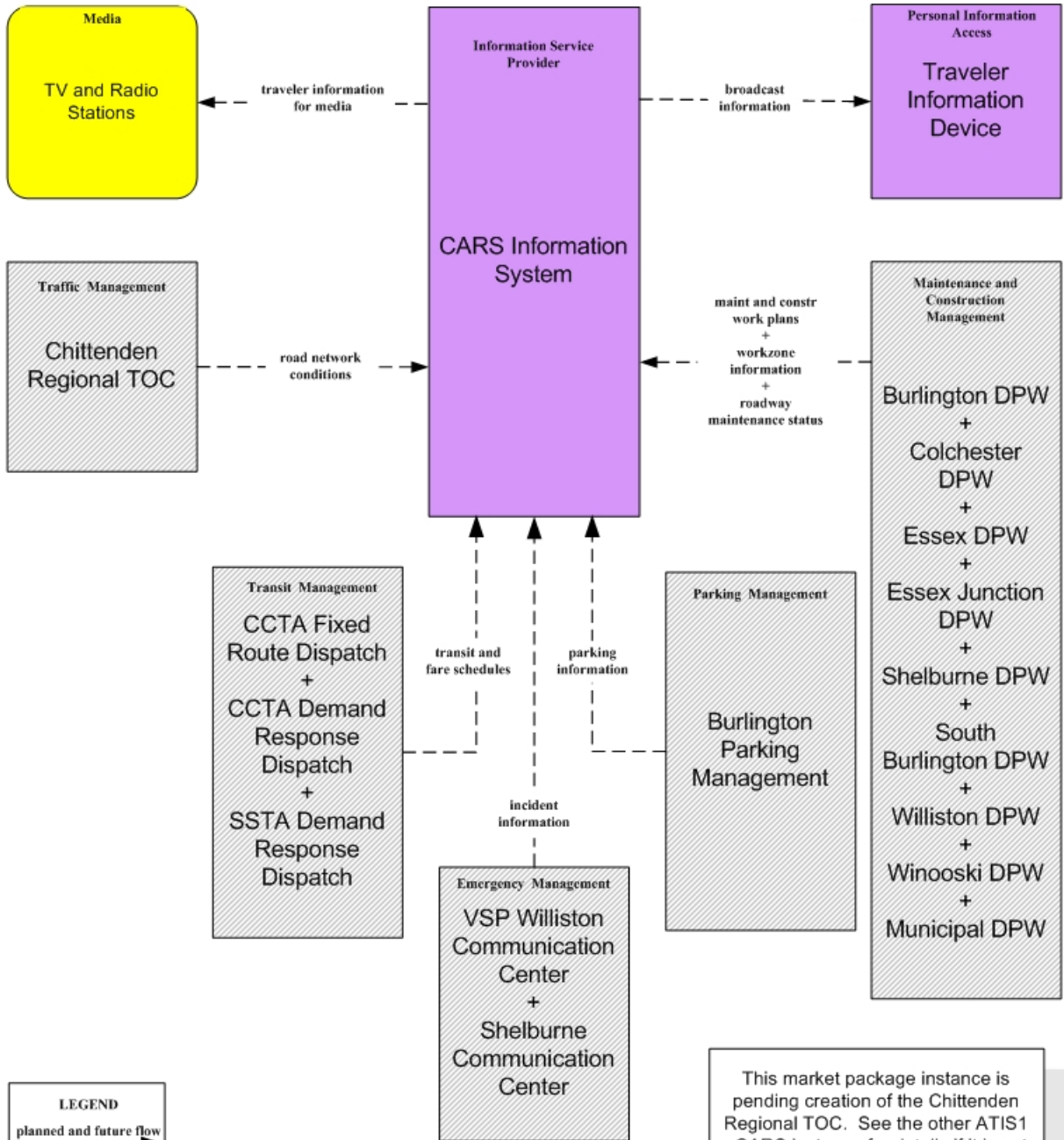

LEGEND

- planned and future flow
- existing flow
- user defined flow

This market package instance is pending creation of the Chittenden Regional TOC. See the other ATIS1 – CARS instance for details if it is not.

ATIS1 - Broadcast Traveler Information
Colchester Website

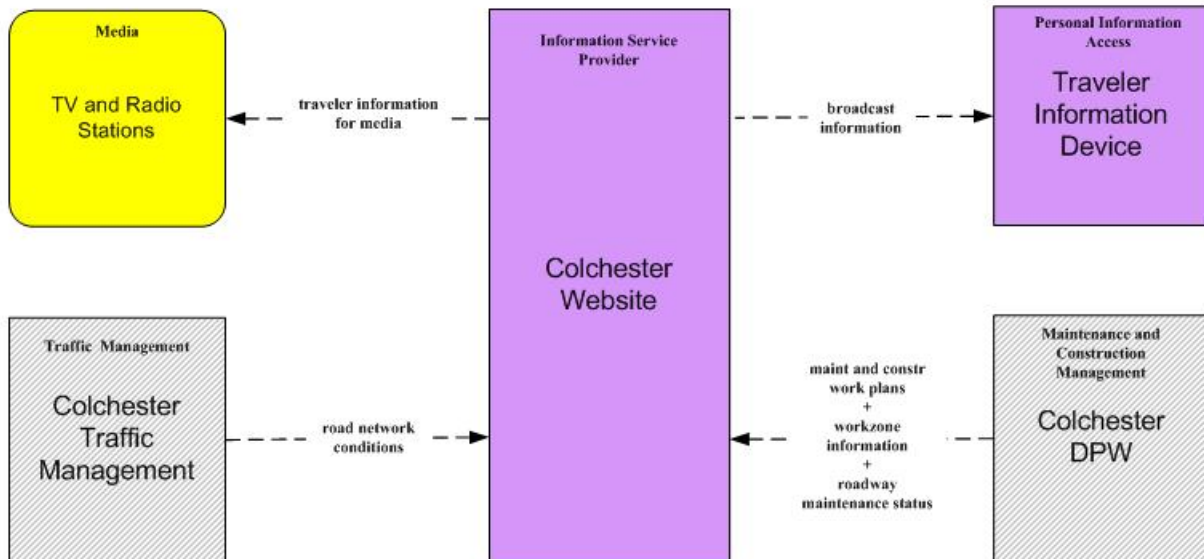

LEGEND

planned and future flow

existing flow

user defined flow

ATIS1 - Broadcast Traveler Information Essex Website

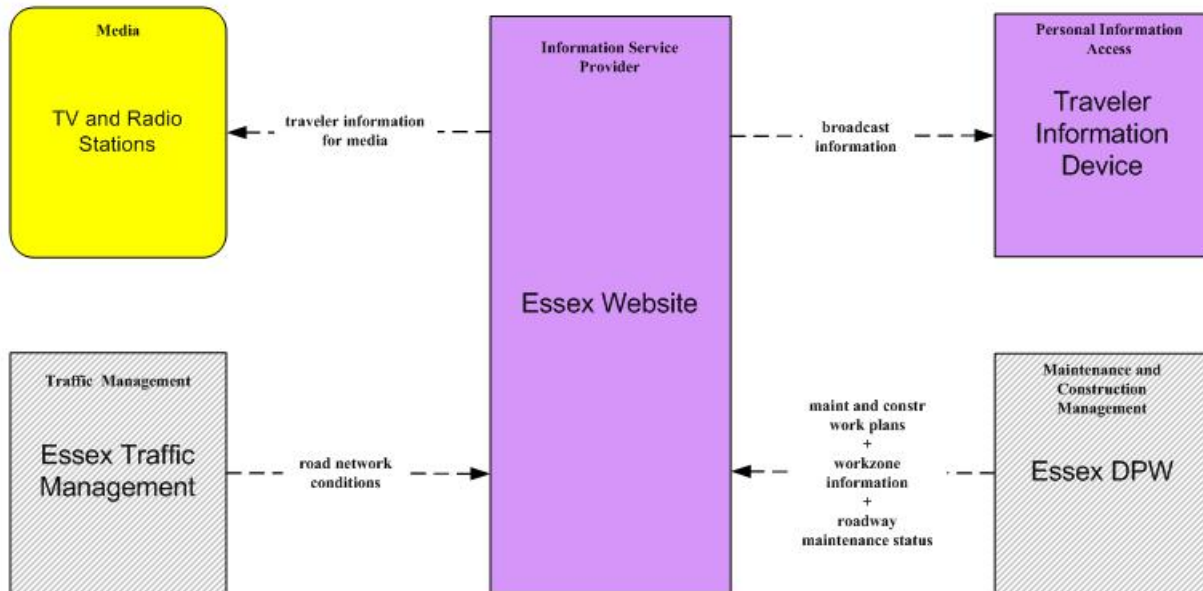

LEGEND

planned and future flow →

existing flow →

user defined flow →

ATIS1 - Broadcast Traveler Information Essex Junction Website

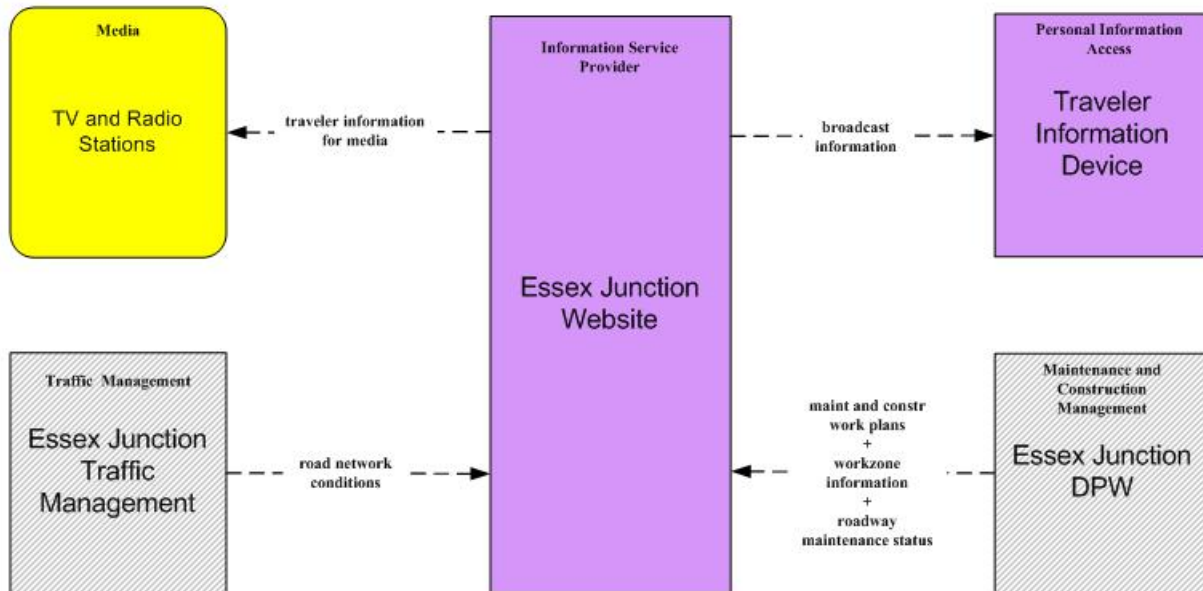

LEGEND

planned and future flow →

existing flow →

user defined flow →

ATIS1 - Broadcast Traveler Information Municipal Websites

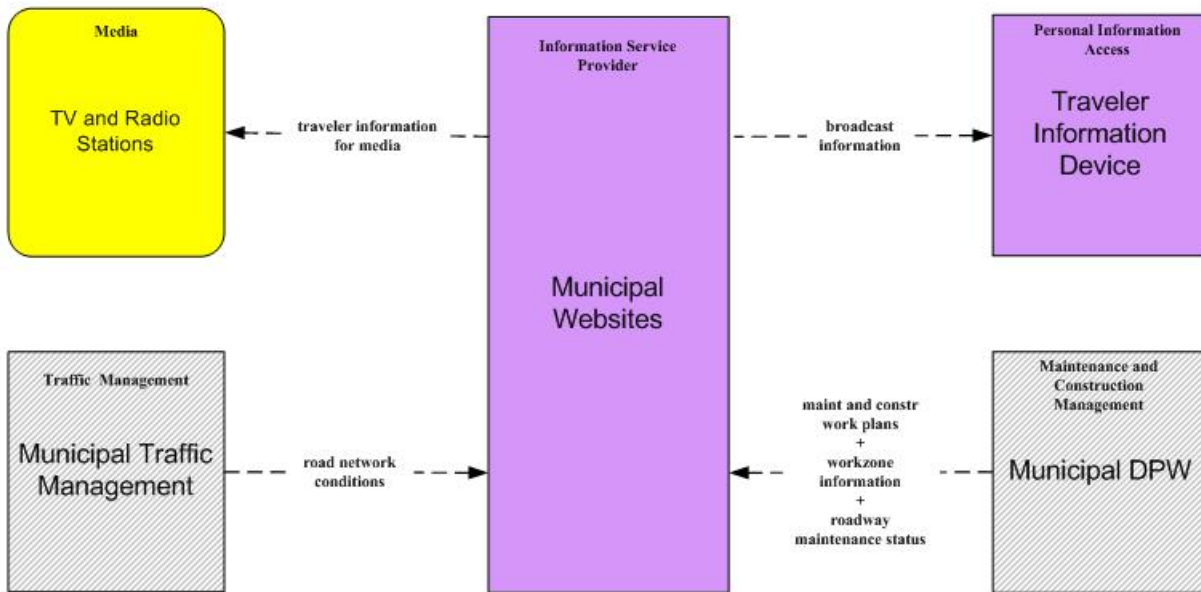

LEGEND

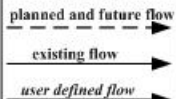

ATIS1 - Broadcast Traveler Information Shelburne Website

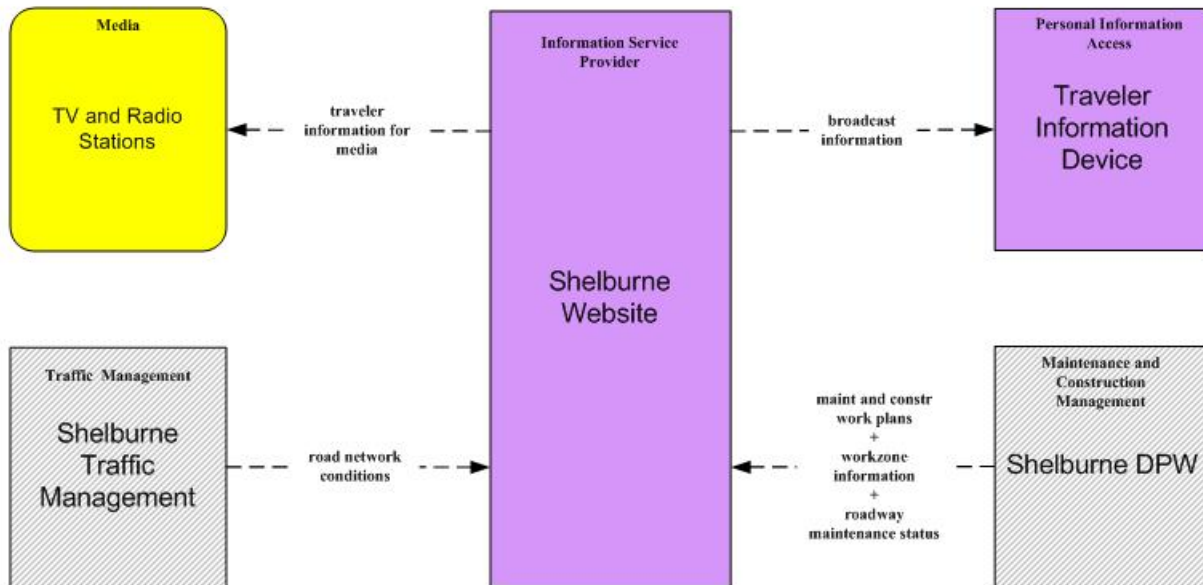

LEGEND

planned and future flow

existing flow

user defined flow

ATIS1 - Broadcast Traveler Information South Burlington Website

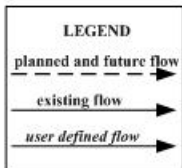
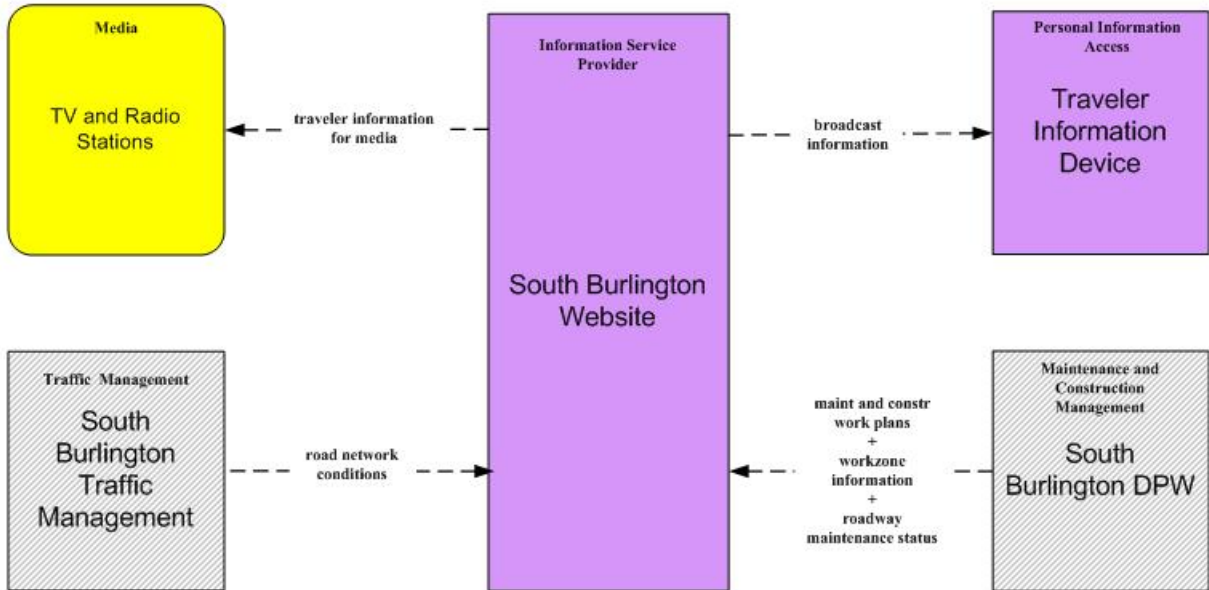

ATIS1 - Broadcast Traveler Information
Williston Website

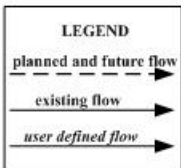
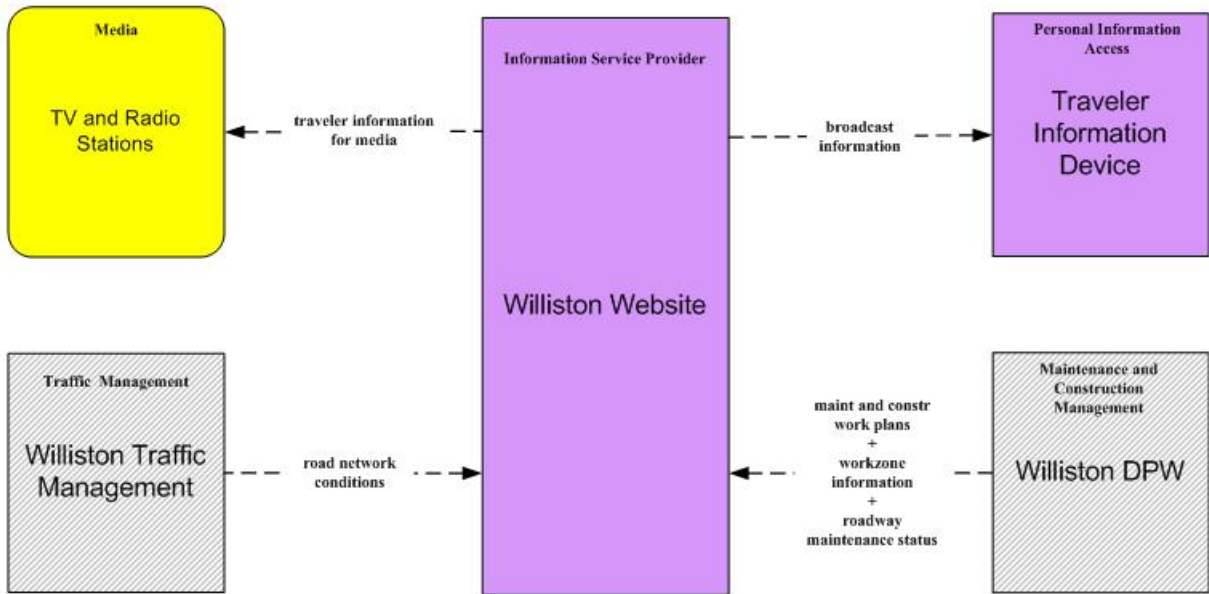

ATIS1 - Broadcast Traveler Information Winooski Website

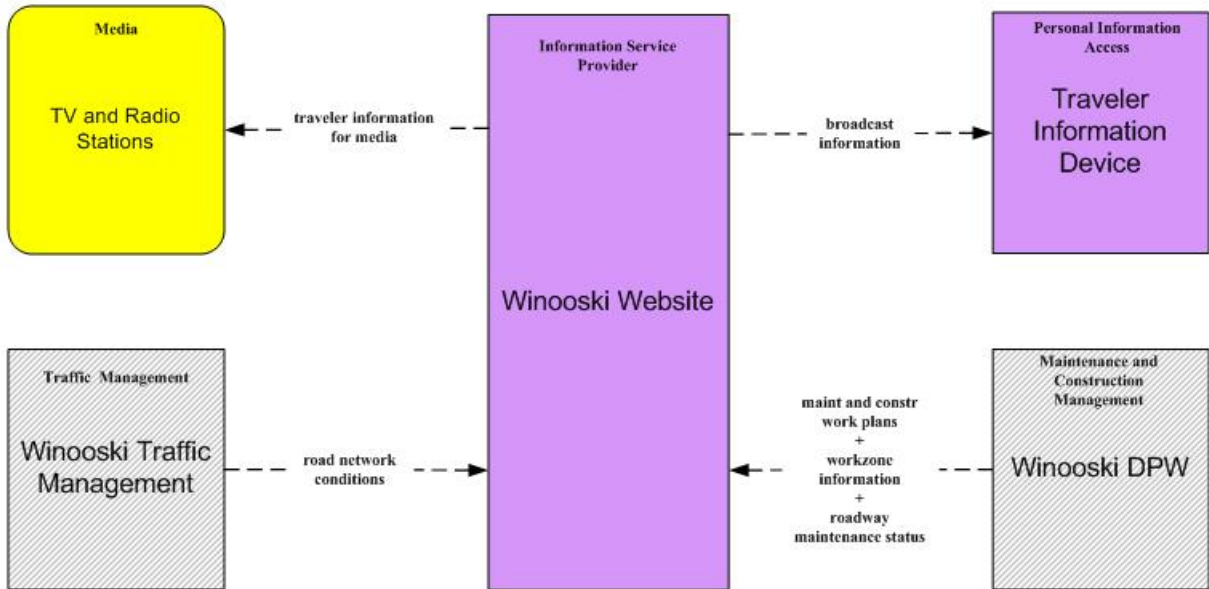

LEGEND

planned and future flow →

existing flow →

user defined flow →

ATIS2 – Interactive Traveler Information Vermont Travel Planner

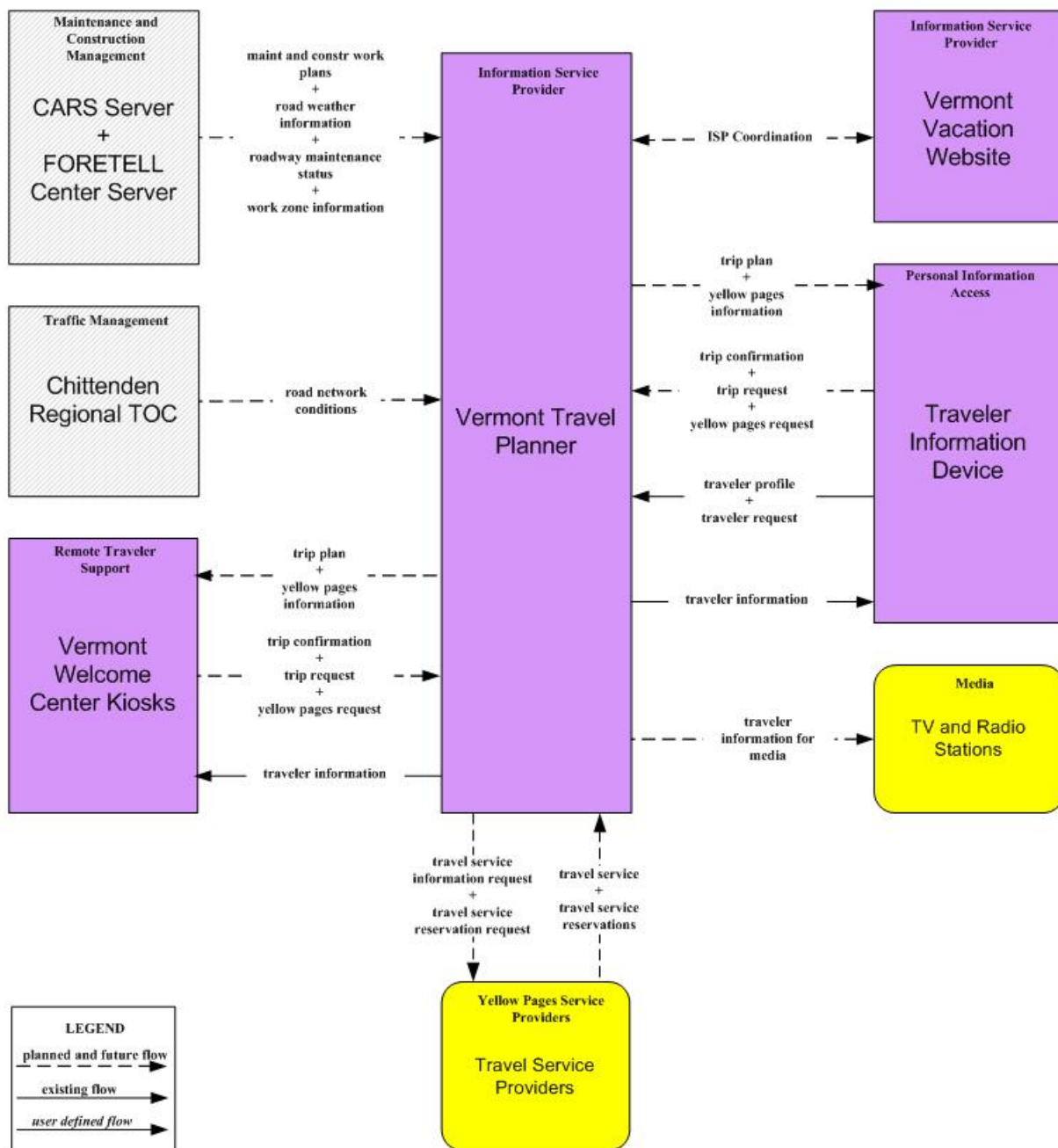

ATMS06 – Traffic Information Dissemination
Burlington Traffic Management

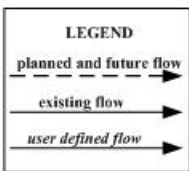
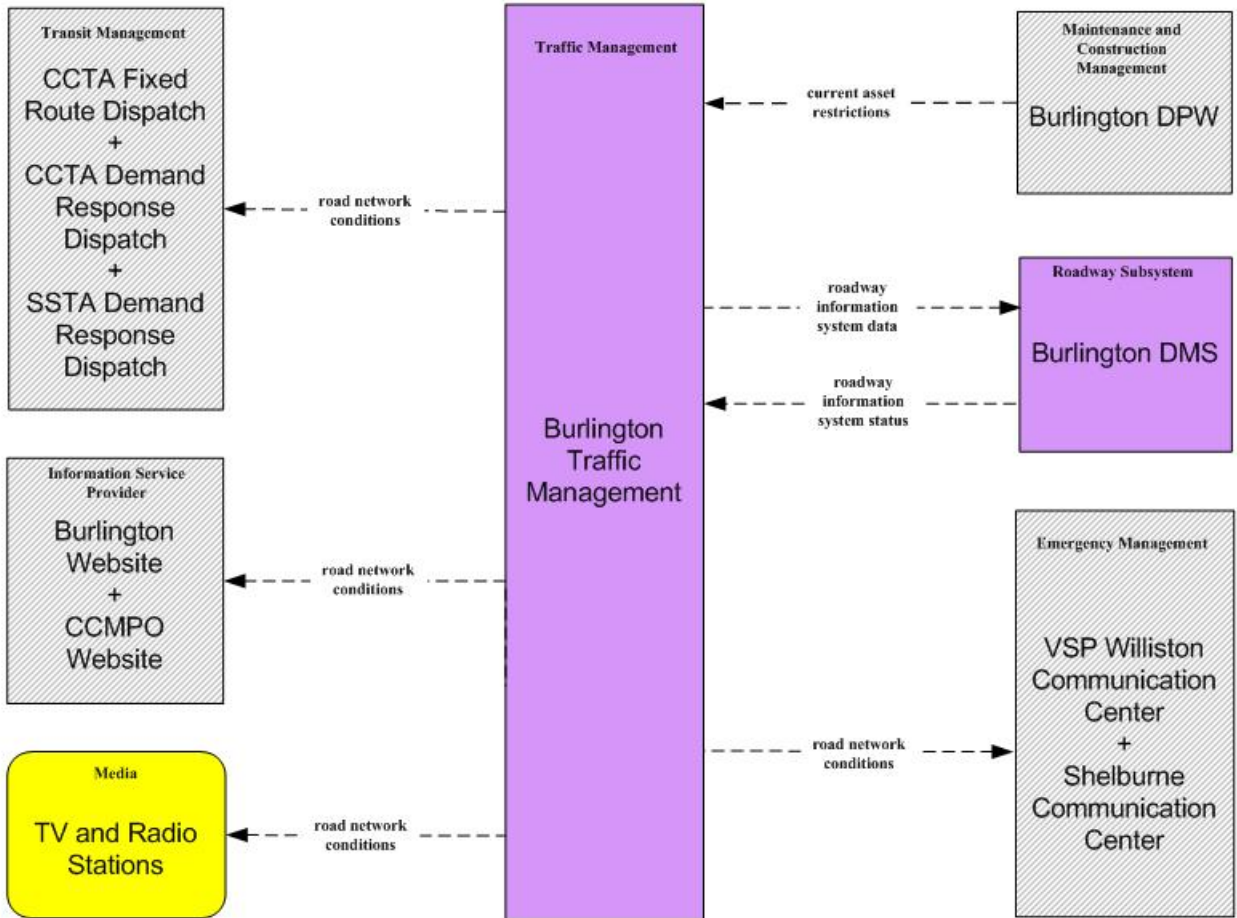

ATMS06 – Traffic Information Dissemination Colchester Traffic Management

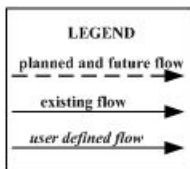
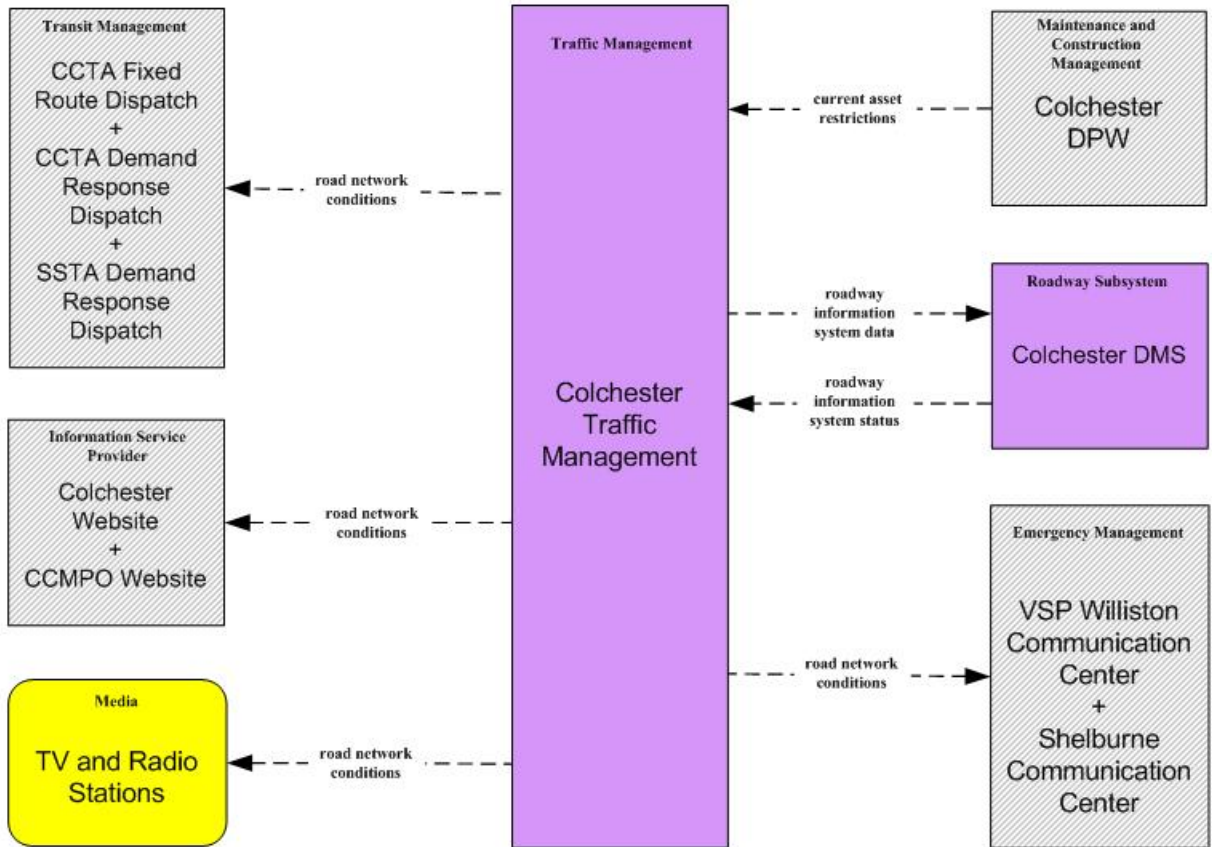

ATMS06 – Traffic Information Dissemination Chittenden Regional TOC (Future)

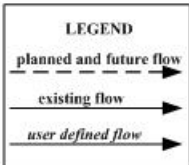
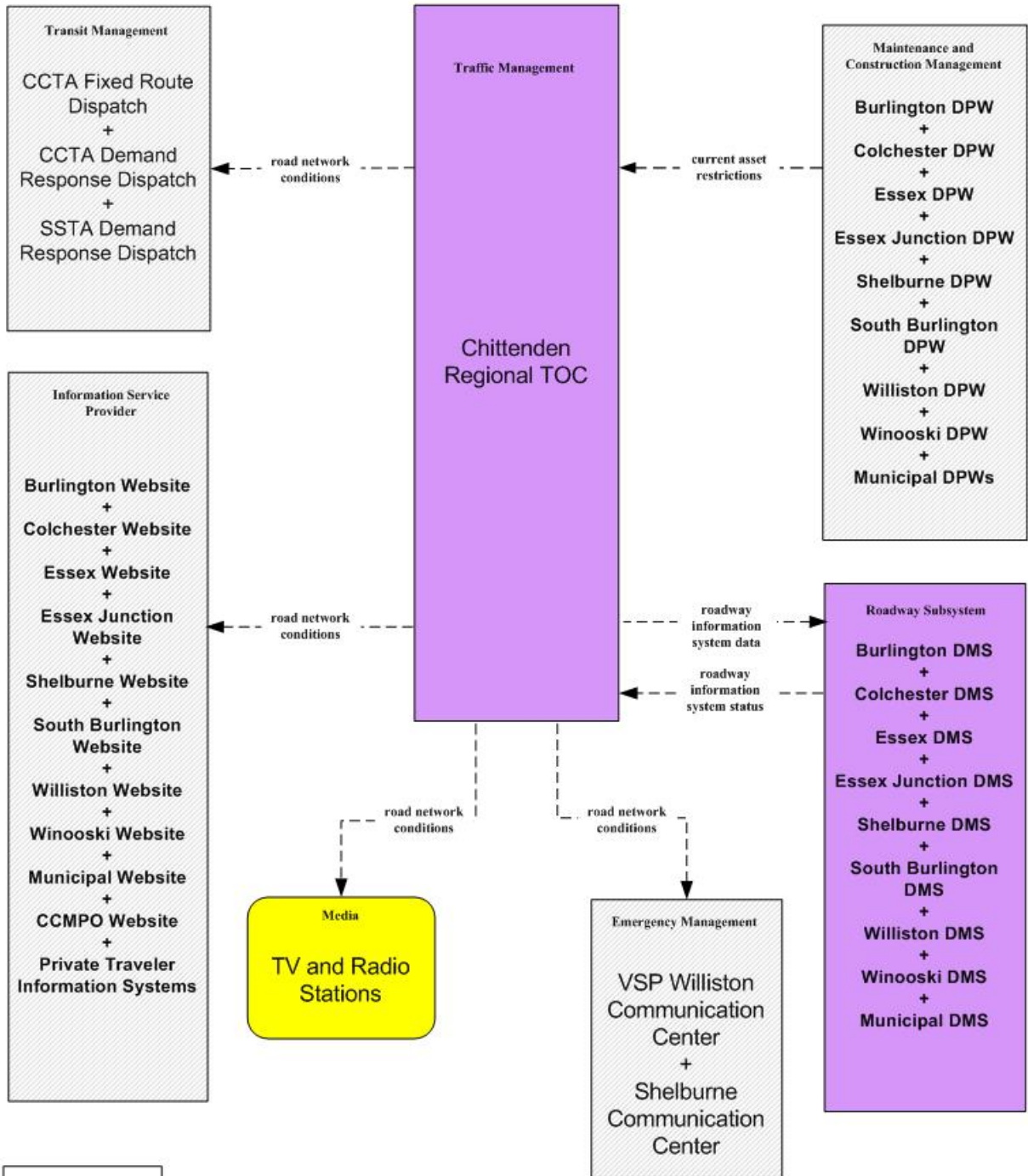

ATMS06 – Traffic Information Dissemination
Essex Traffic Management

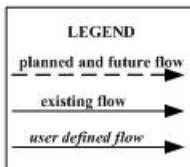
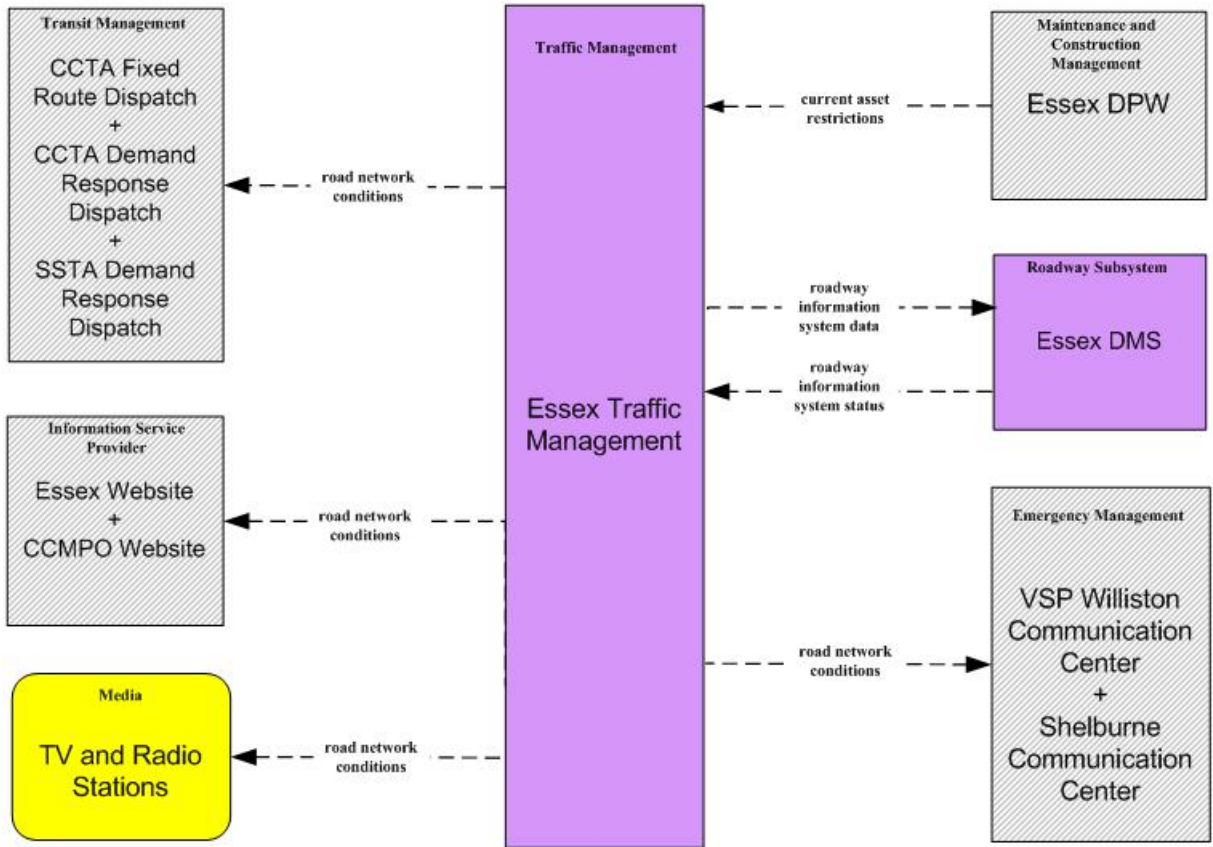

ATMS06 – Traffic Information Dissemination
Essex Junction Traffic Management

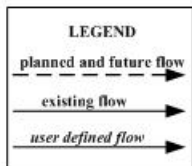
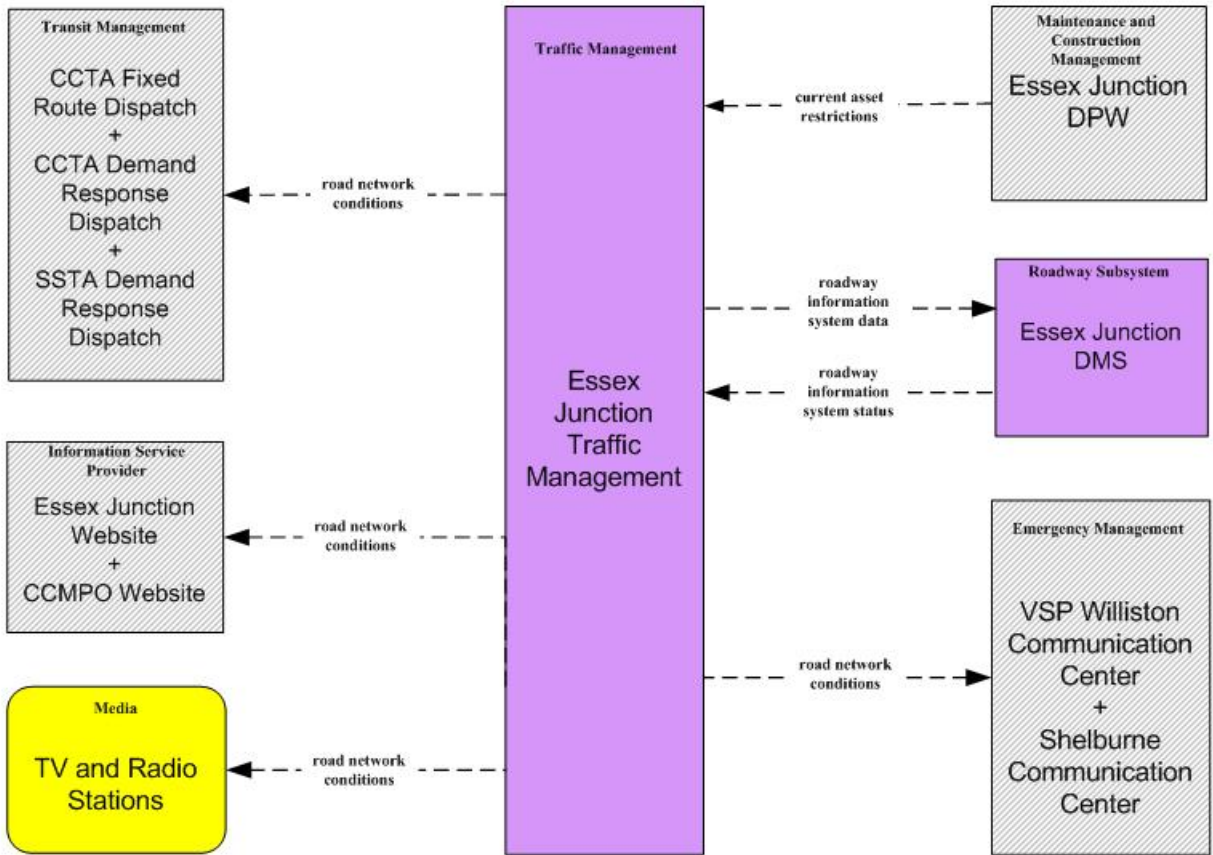

**ATMS06 – Traffic Information Dissemination
Municipal Traffic Management**

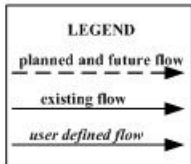
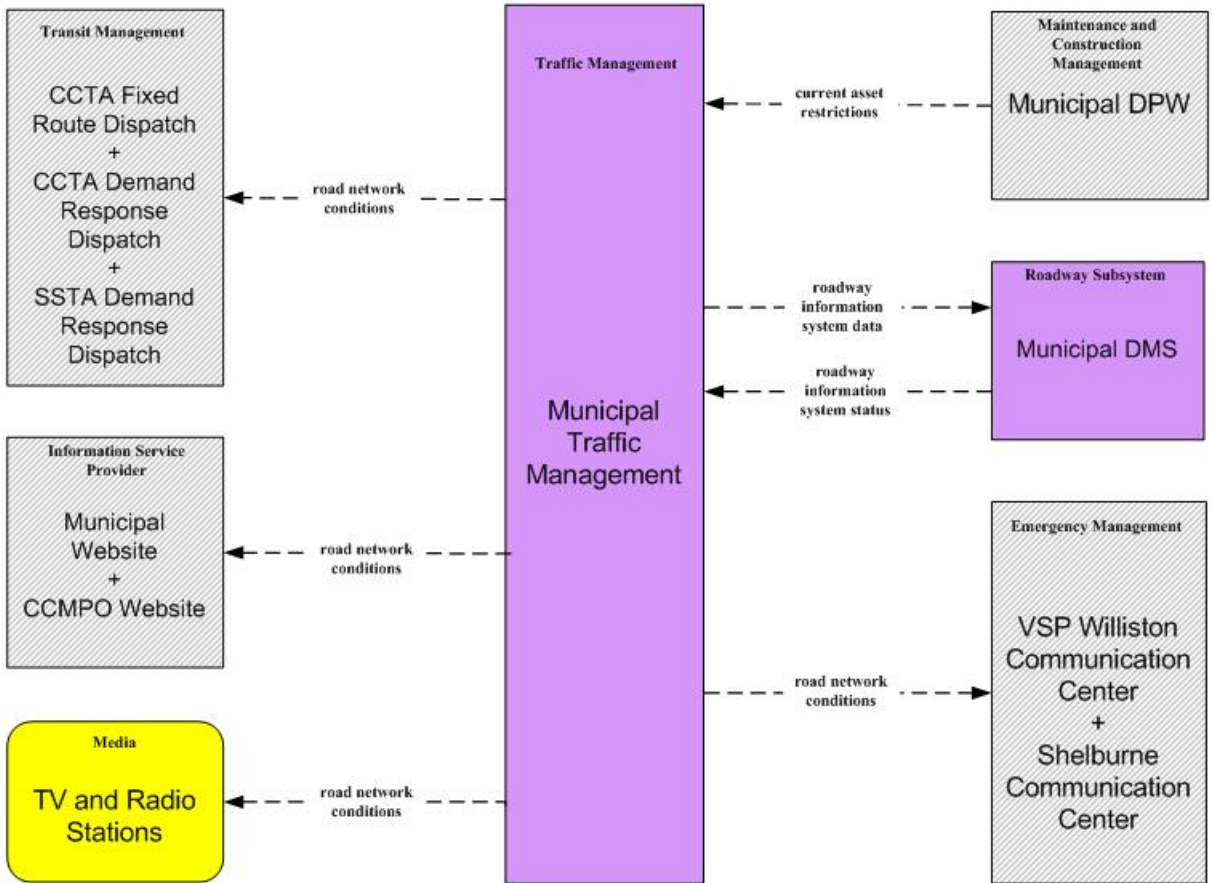

ATMS06 – Traffic Information Dissemination
Shelburne Traffic Management

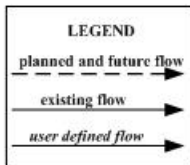
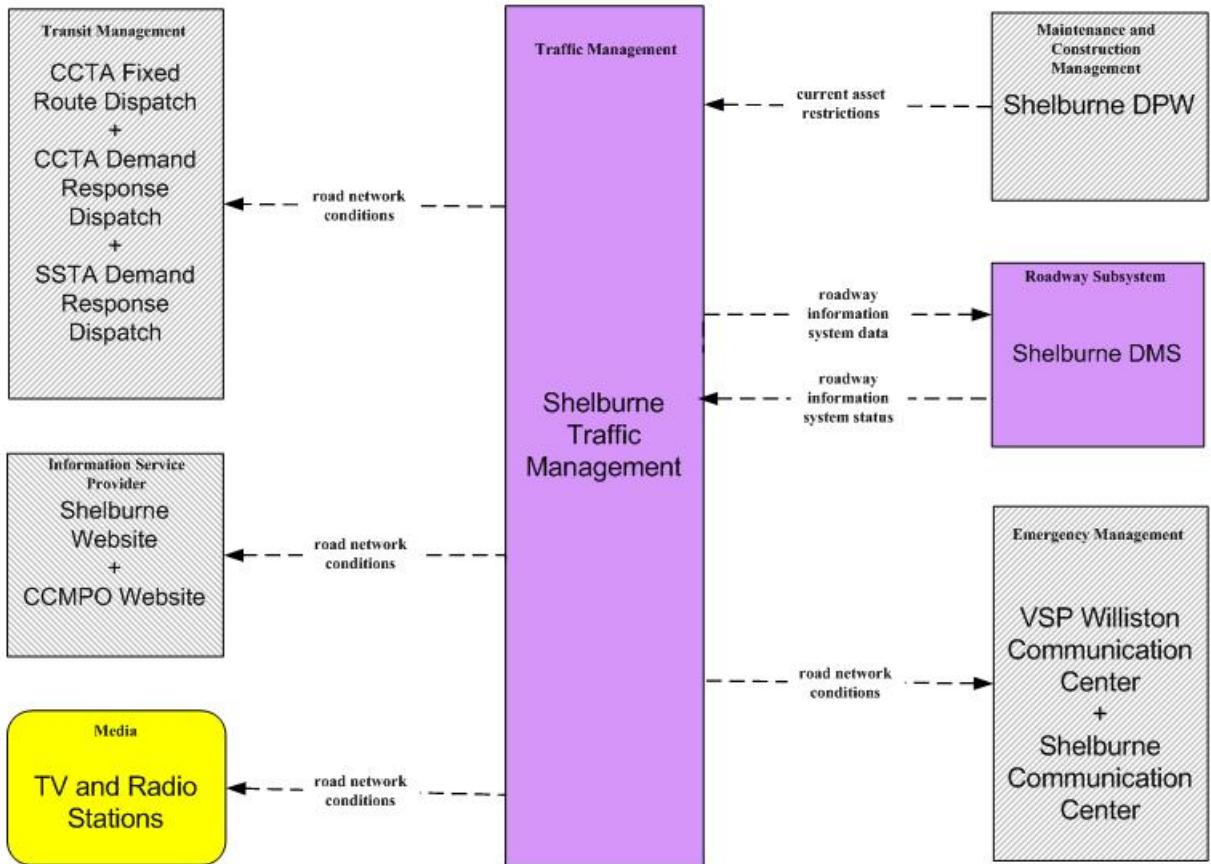

ATMS06 – Traffic Information Dissemination South Burlington Traffic Management

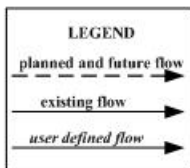
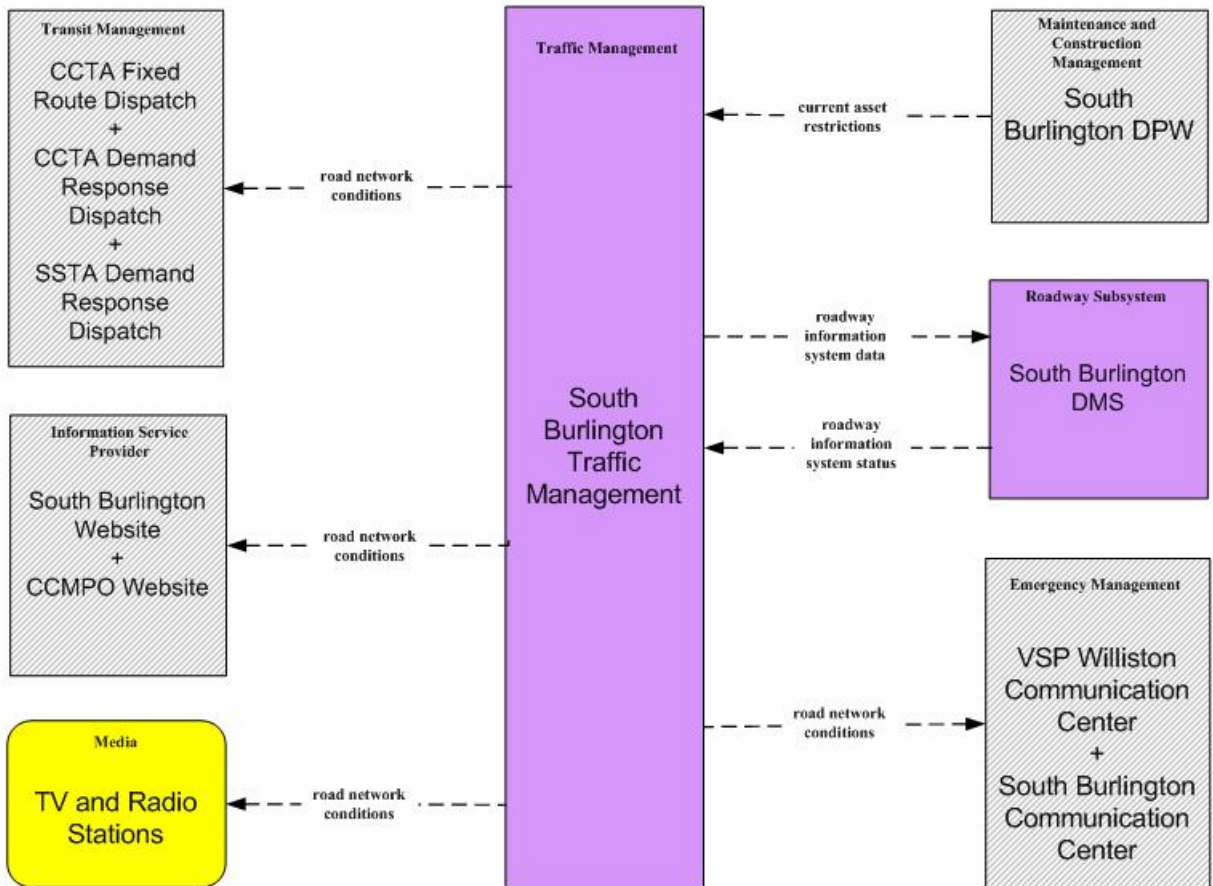

ATMS06 – Traffic Information Dissemination
Williston Traffic Management

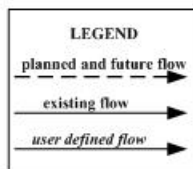
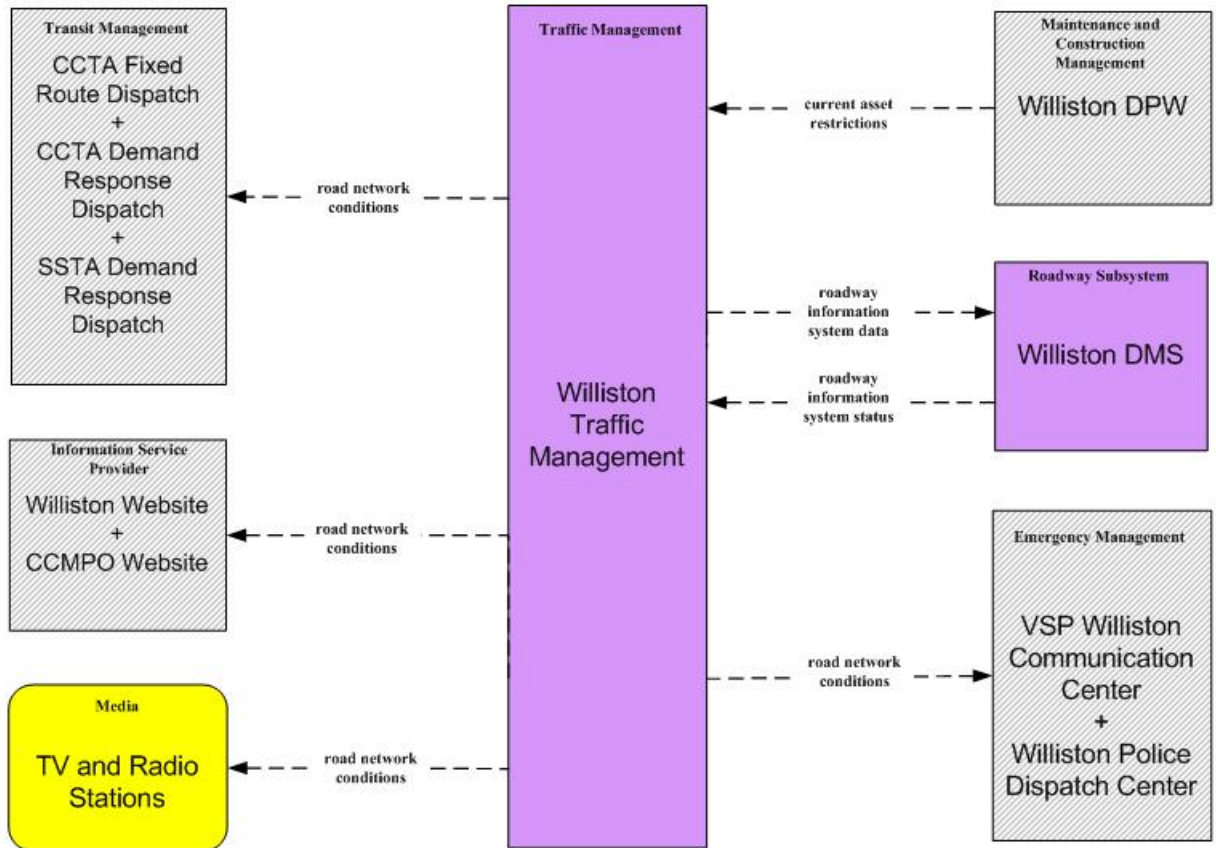

ATMS06 – Traffic Information Dissemination Winooski Traffic Management

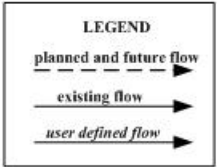
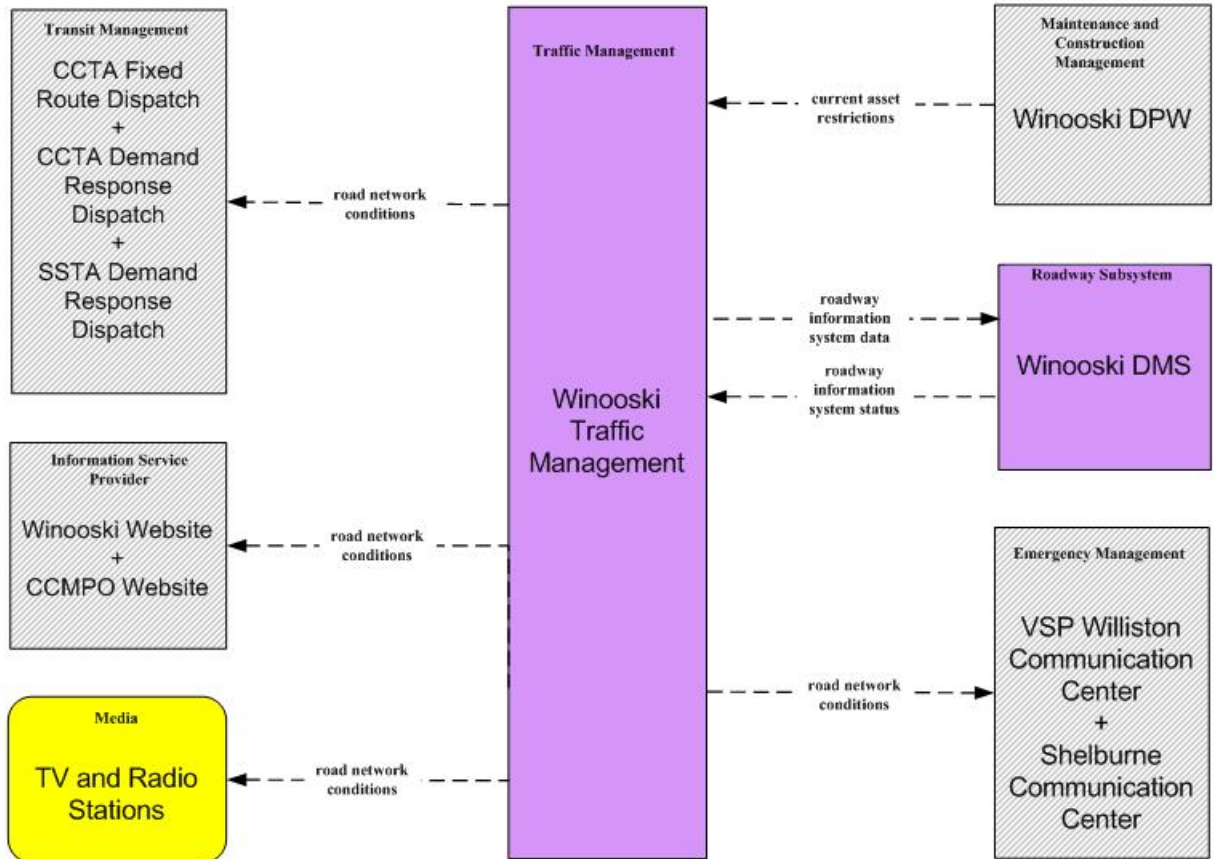

**EMO6 – Wide Area Alert
Vermont Statewide EOC & VSP Headquarters**

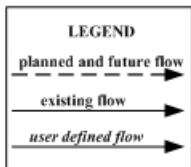
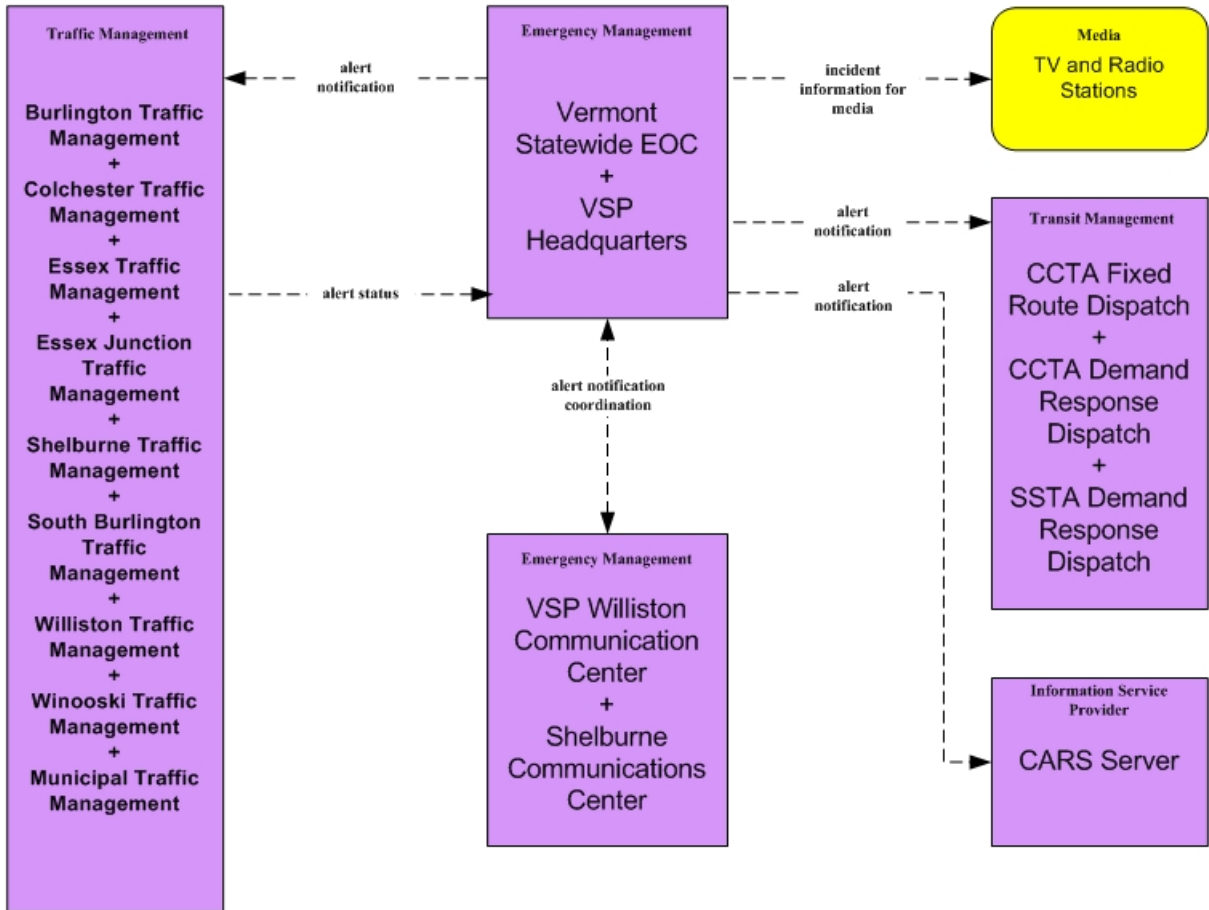

EMO6 – Wide Area Alert
 Vermont Statewide EOC & VSP Headquarters – Chittenden Regional TOC

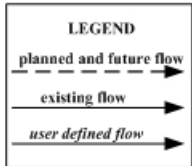
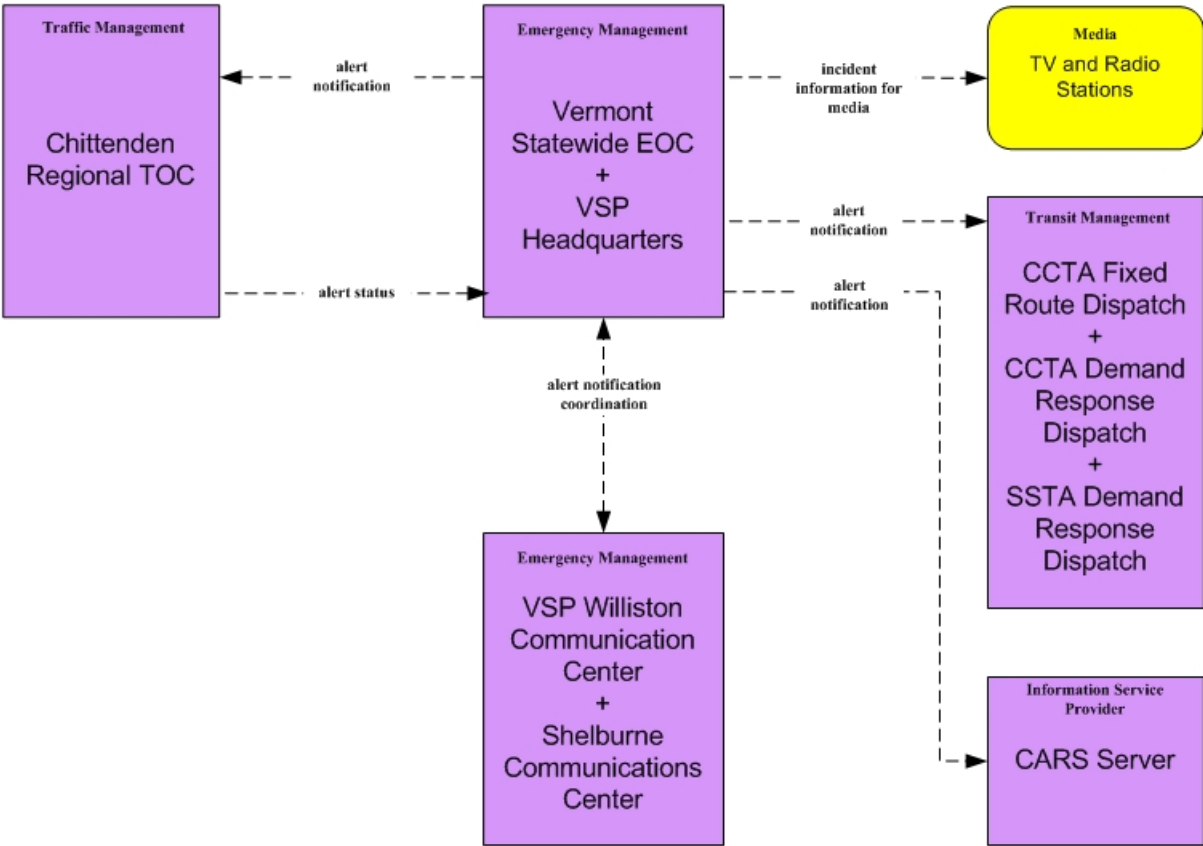

MC04 - Weather Information Processing and Distribution
CARS

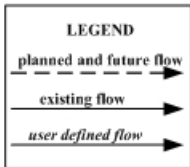
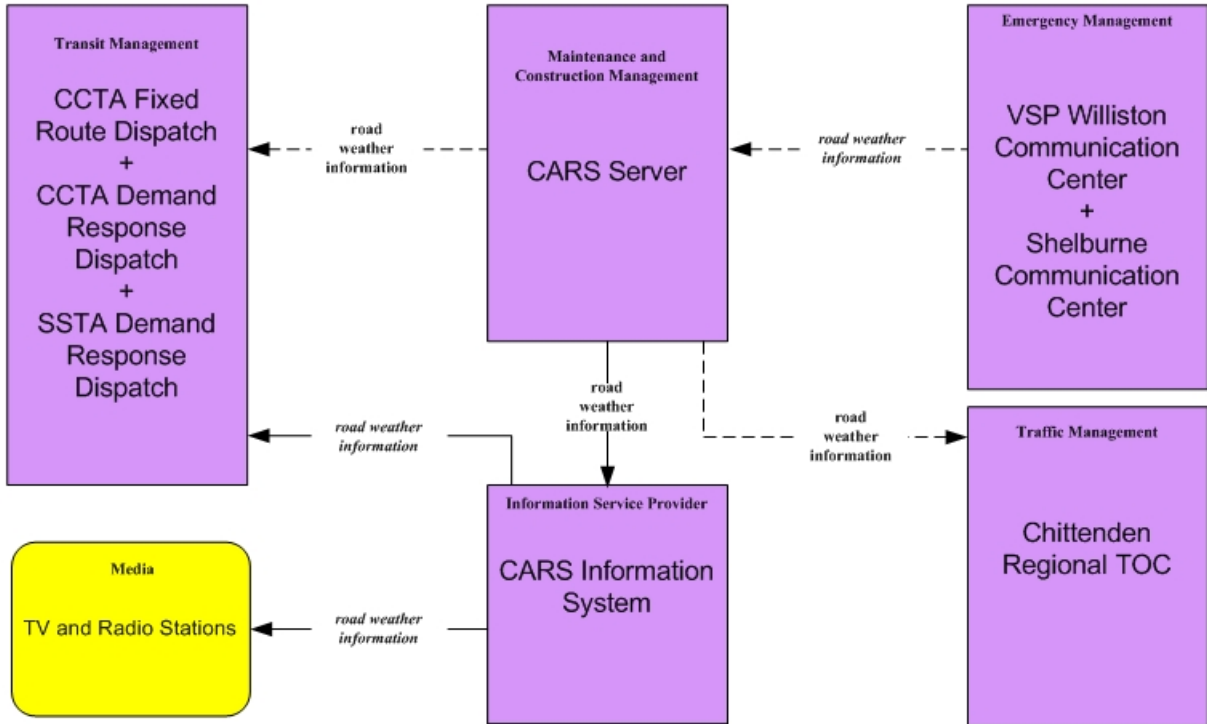

MC04 – Weather Information Processing and Distribution
Chittenden Regional TOC

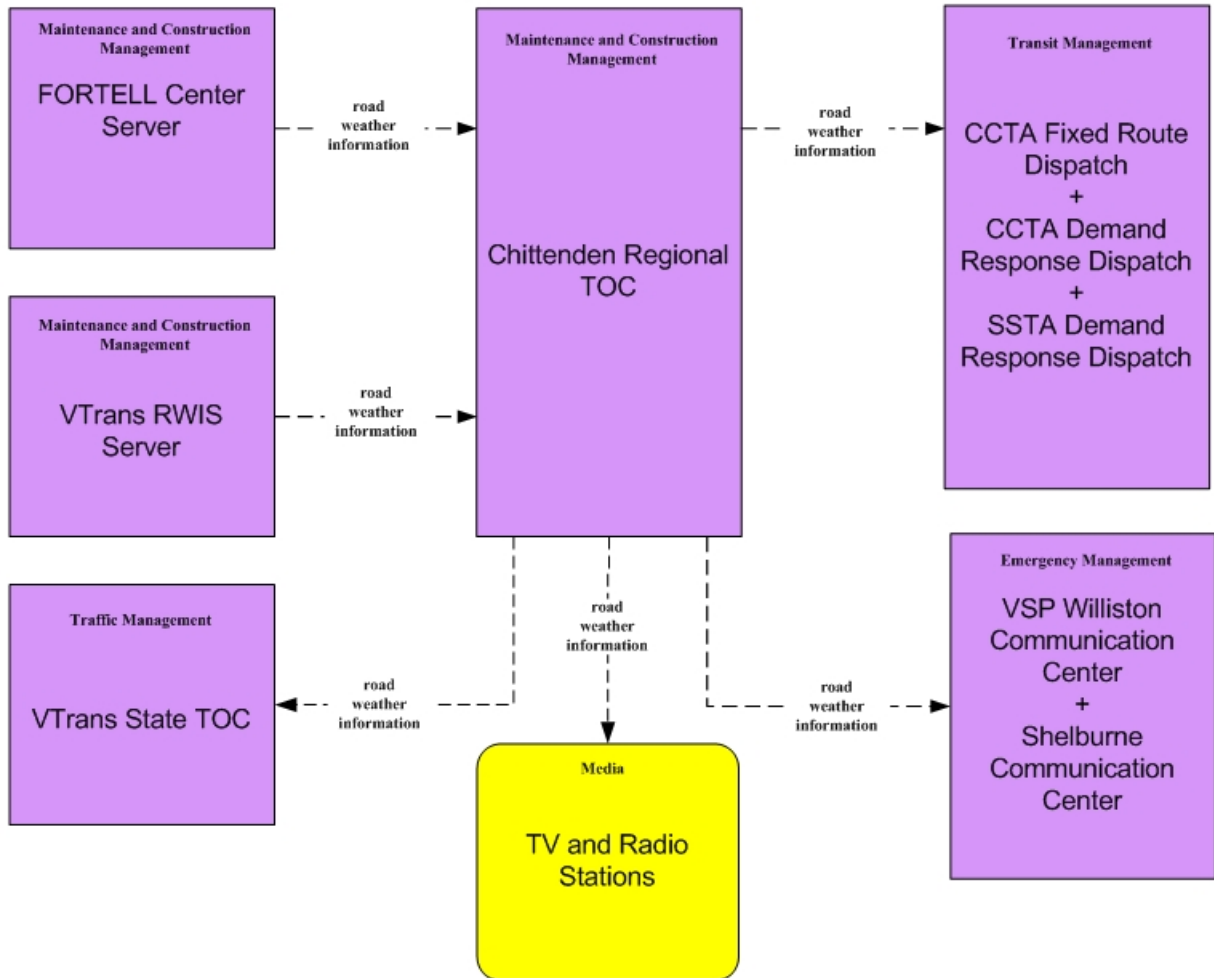

LEGEND

